

# Robotic Endoscope Holder

## MTG-H100

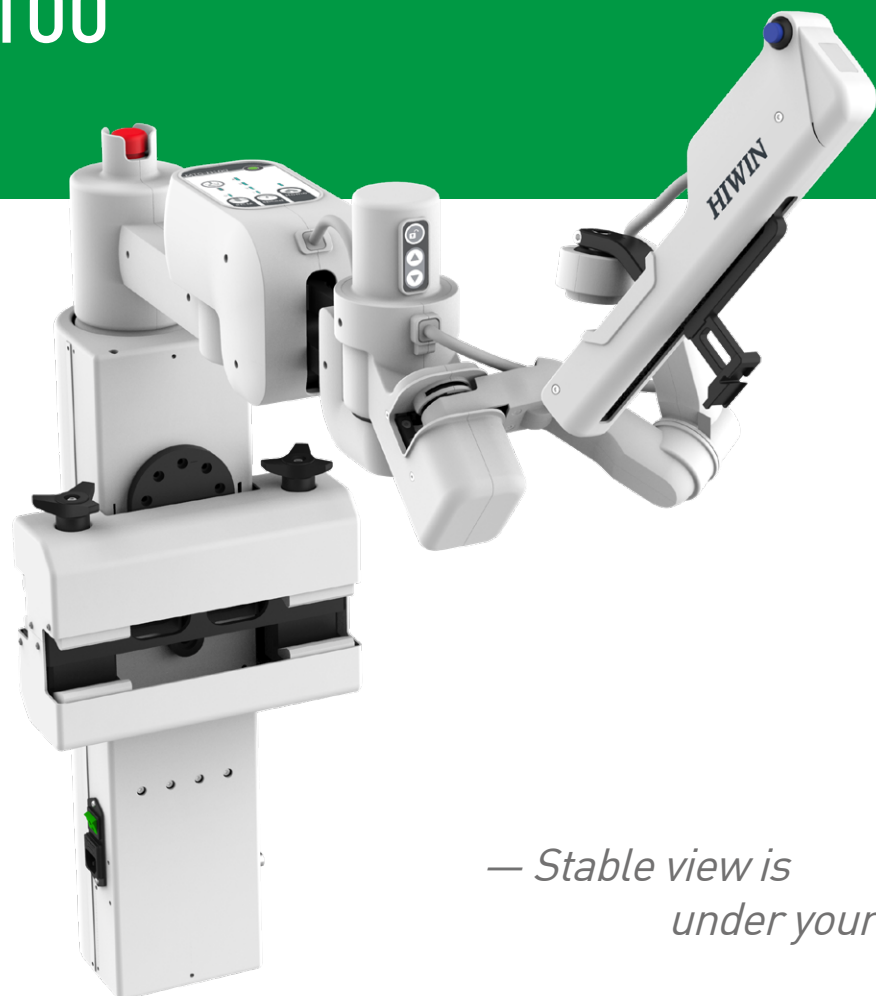

— *Stable view is  
under your control.*

# MTG-H100 Robotic endoscope holder is the solution to endoscopic surgery.

- Steady image
- Minimize wound size
- Intuitive control
- Safe & sterile work



HIWIN Robotic Endoscope Holder

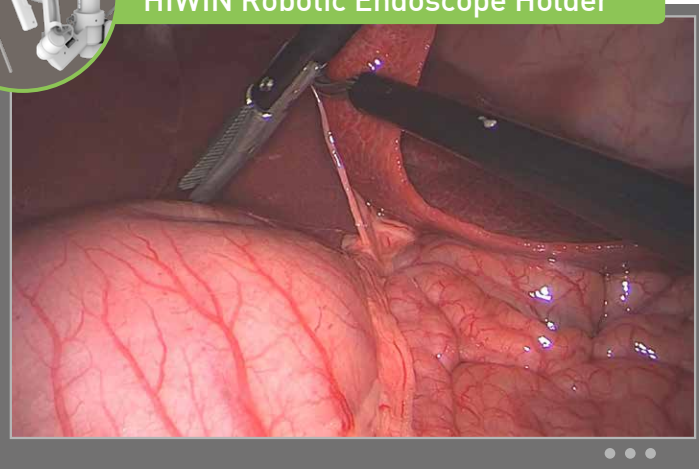

Hand-held



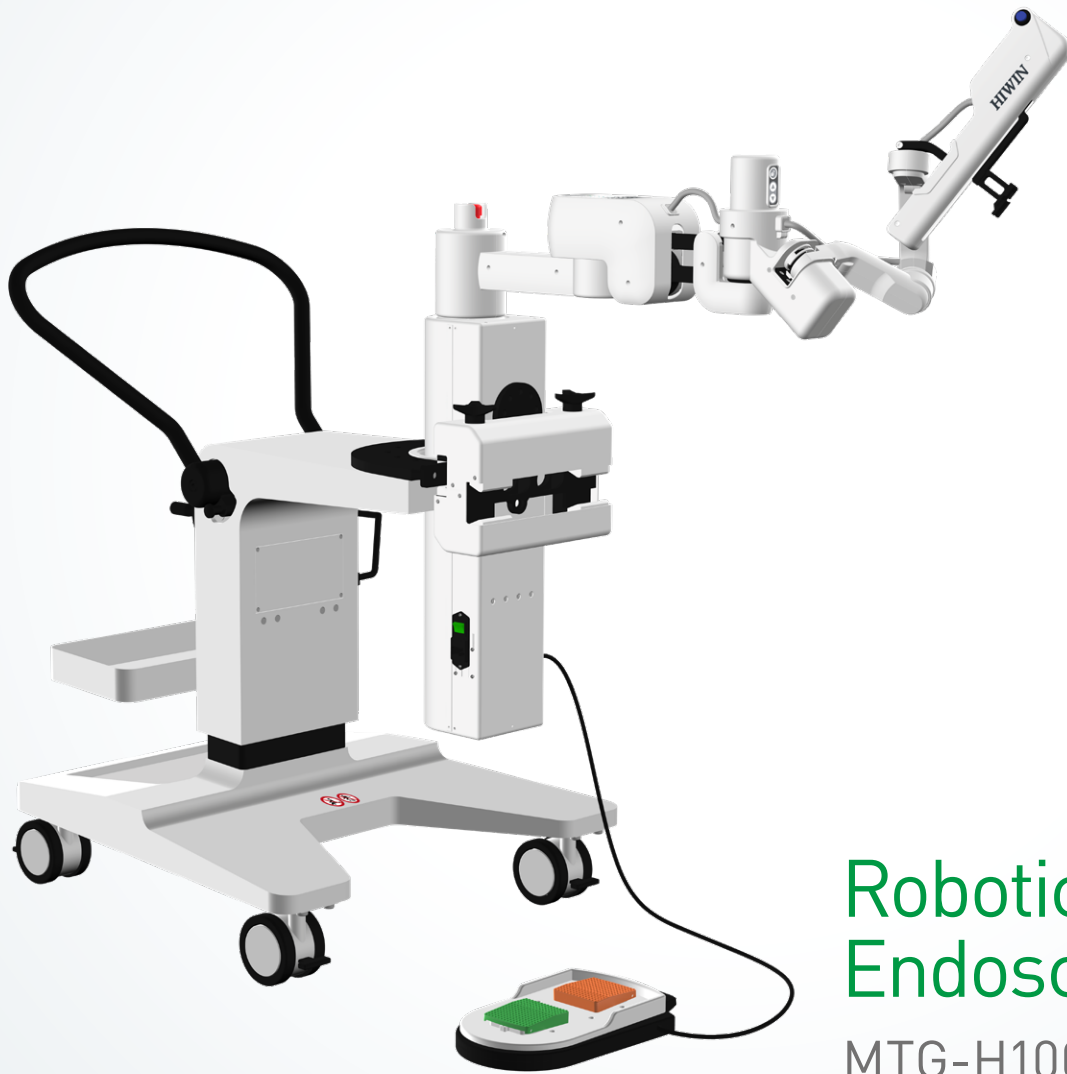

## Robotic Endoscope Holder

MTG-H100

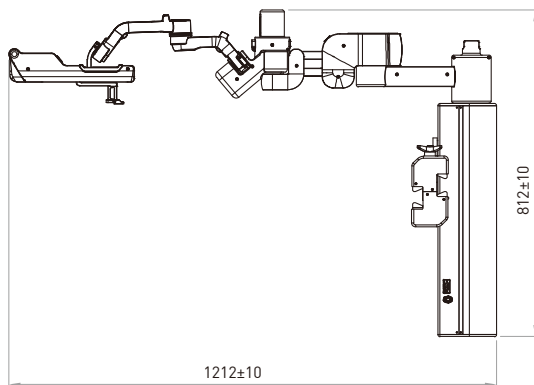
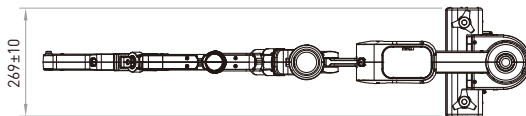

**Dimension :** 1212(L) x 269(W) x 812(H) mm

**Net weight :** Robot: 20.0 kg

Trolley: 92.5 kg

**Supply votage :** AC 100-240V, 50/60Hz

**Max. power consumption :** 120W

**Control methods :** Pedal / Manual

## Benefits /

### Reliable Surgical Assistant

By holding endoscope with Robotic Endoscope Holder during surgery, human fatigue and miscommunication between surgeons and assistants can be eliminated.

### Steady Views

With Robotic Endoscope Holder, steady and clear views are provided to assist surgeons to operate with accuracy and confidence during surgery.

### Enhance Surgical Efficiency

Fewer lens cleanings and stable images contribute to enhance surgical efficiency.

### Minimized Wound Size

The RCM mechanism makes the endoscope moving within fixed point to minimize the wound size by preventing possible force applied on the incision.

### Assured Safety

The stable holder which precisely controls the endoscope offers a steady image and enables fatigue-free work for medical staff to ensure patient safety.

### Workflow & Environment Compatibility

Robotic Endoscope Holder can be integrated into existing surgical process and equipment to reduce adaptation costs.

## Support to endoscopic surgery /



General Surgery



Gynecology



Thoracic Surgery

## Position /

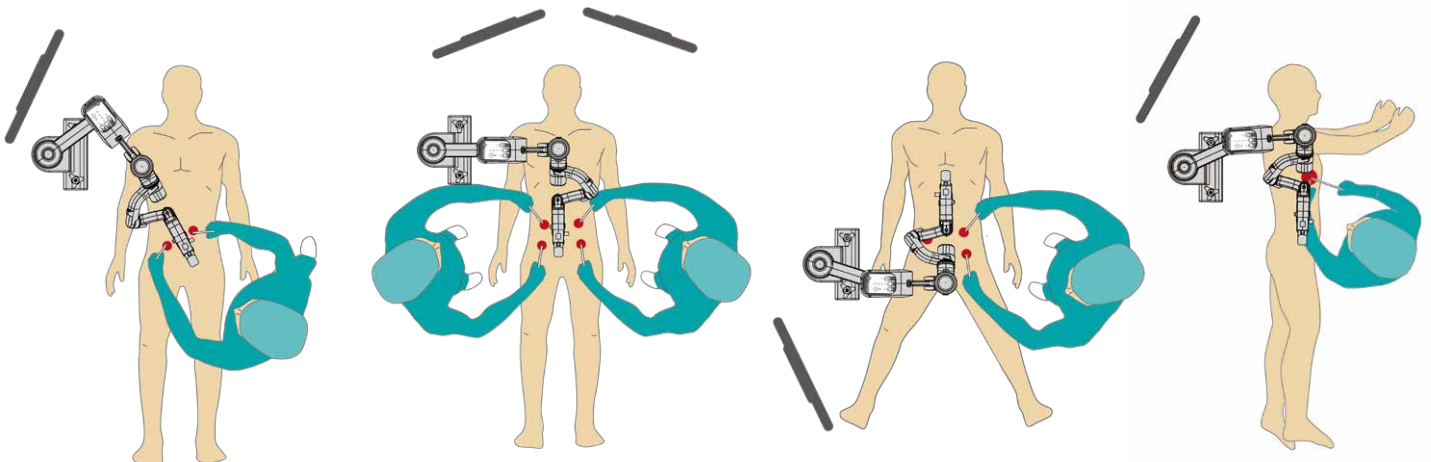



### RCM Technology

Mechanically embedded Remote Center of Motion (RCM) generates precise movement and ensures minimal incision size.

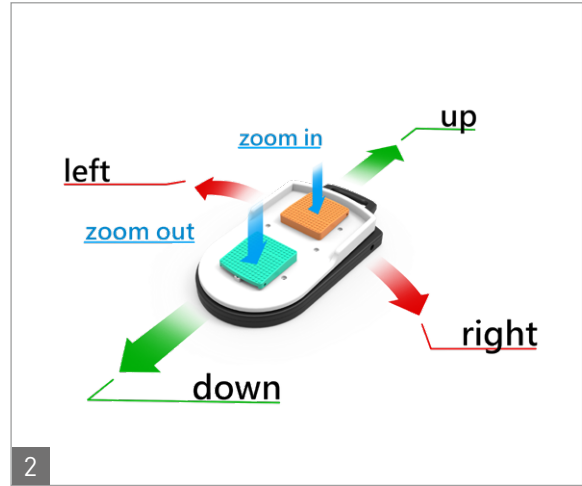

### Intuitive Pedal

Robotic Endoscope Holder can be controlled with the intuitive pedal which allows self-directing endoscope and shorter the learning curve.



### Quick Setup & Mobility

It can be easily mounted onto operating tables or operated directly on the trolley, adapting to different surgical positions.



### Disposable Sterile Drape

It is covered with the sterile, single-use drape to ensure hygiene and safe operations.

## Item Information /

Item	Content
MTG-H100 Set	1. MTG-H100 2. Pedal 3. Trolley
Sterile accessory	1. Disposable fastener 2. Disposable arm drape

## Global Sales And Customer Service Site

### HIWIN GmbH

OFFENBURG, GERMANY  
www.hiwin.de  
www.hiwin.eu  
info@hiwin.de

### HIWIN JAPAN

KOBE • TOKYO • NAGOYA • NAGANO •  
TOHOKU • SHIZUOKA • HOKURIKU •  
HIROSHIMA • FUKUOKA • KUMAMOTO,  
JAPAN  
www.hiwin.co.jp  
info@hiwin.co.jp

### HIWIN USA

CHICAGO, U.S.A.  
www.hiwin.com  
info@hiwin.com

### HIWIN Srl

BRUGHERIO, ITALY  
www.hiwin.it  
info@hiwin.it

### HIWIN Schweiz GmbH

JONA, SWITZERLAND  
www.hiwin.ch  
info@hiwin.ch

### HIWIN s.r.o.

BRNO, CZECH REPUBLIC  
www.hiwin.cz  
info@hiwin.cz

### HIWIN FRANCE

STRASBOURG, FRANCE  
www.hiwin.fr  
info@hiwin.de

### HIWIN SINGAPORE

SINGAPORE  
www.hiwin.sg  
info@hiwin.sg

### HIWIN KOREA

SUWON • CHANGWON, KOREA  
www.hiwin.kr  
info@hiwin.kr

### HIWIN CHINA

SUZHOU, CHINA  
www.hiwin.cn  
info@hiwin.cn

### Mega-Fabs Motion Systems, Ltd.

HAIFA, ISRAEL  
www.mega-fabs.com  
info@mega-fabs.com

### HIWIN TECHNOLOGIES CORP.

No. 7, Jingke Road,  
Taichung Precision Machinery Park,  
Taichung 40852, Taiwan  
Tel: +886-4-23594510  
Fax: +886-4-23594420  
www.hiwin.tw  
info@hiwinhealthcare.com

- HIWIN is a registered trademark of HIWIN Technologies Corp. For your protection, avoid buying counterfeit products from unknown sources.
- Actual products may differ from specifications and photos provided in this catalog. These differences may be the result of various factors including product improvements.
- HIWIN website for patented product directory: [http://www.hiwin.tw/Products/Products\\_patents.aspx](http://www.hiwin.tw/Products/Products_patents.aspx)
- HIWIN will not sell or export products or processes restricted under the "Foreign Trade Act" or related regulations. Export of restricted products should be approved by proper authorities in accordance with relevant laws and shall not be used to manufacture or develop nuclear, biochemical, missiles or other weapons.

The specifications in this catalog are subject to change without notification.

Copyright © HIWIN Technologies Corp.

©2020 FORM H02DE04-2007 (PRINTED IN TAIWAN)