

Cone Beam 3D Imaging
NewTom
what's next



CEFLA s.c.
Via Selice Provinciale 23/a • 40026 Imola • Italy
t. +39 045 8202727 • 045 583500
info@newtom.it

newtom.it

06/2018 N5GXGB181500
According to the standards in force, in extra-EU areas the availability and specifications of some products and/or characteristics may vary. Please contact your local distributor for further information. Pictures are for illustration purpose only.

NewTom 5G XL EXTRA.VISION

THE ULTIMATE 3D



Cone Beam 3D Imaging
NewTom
what's next



5G XL EXTRA.VISION

THE ONLY CBCT WITH
LYING DOWN PATIENT
POSITIONING.
EXCELLENT
IMAGE QUALITY
WITH A DEVICE
THAT FEATURES
OUTSTANDING
DIAGNOSTIC
POTENTIAL.

5G XL is the innovative device, featuring lying down patient positioning, able to offer high resolution volumetric images with extra low X-ray doses. Top quality CBCT for new medical applications.

CUTTING EDGE PERFORMANCE FOR ADVANCED DIAGNOSTICS.

Quality and innovation with a device presenting exceptional features.

Advanced diagnostics with 5G XL, the only CBCT device with lying down patient positioning that offers excellent stabilisation and a broad range of FOVs for very high quality 3D and 2D images.

The CBCT technology allows to have high spatial resolution for bone tissue investigations with low X-Ray dose. Special focus on patient health, enhanced by ECO Dose mode and the exclusive SafeBeam™ technology.

5G XL is the first device with native FOV 21 x 19 cm for highly detailed investigations. The ideal device that produces clear, high definition images for orthopaedics, otorhinolaryngology, maxillofacial surgery and dentistry applications.

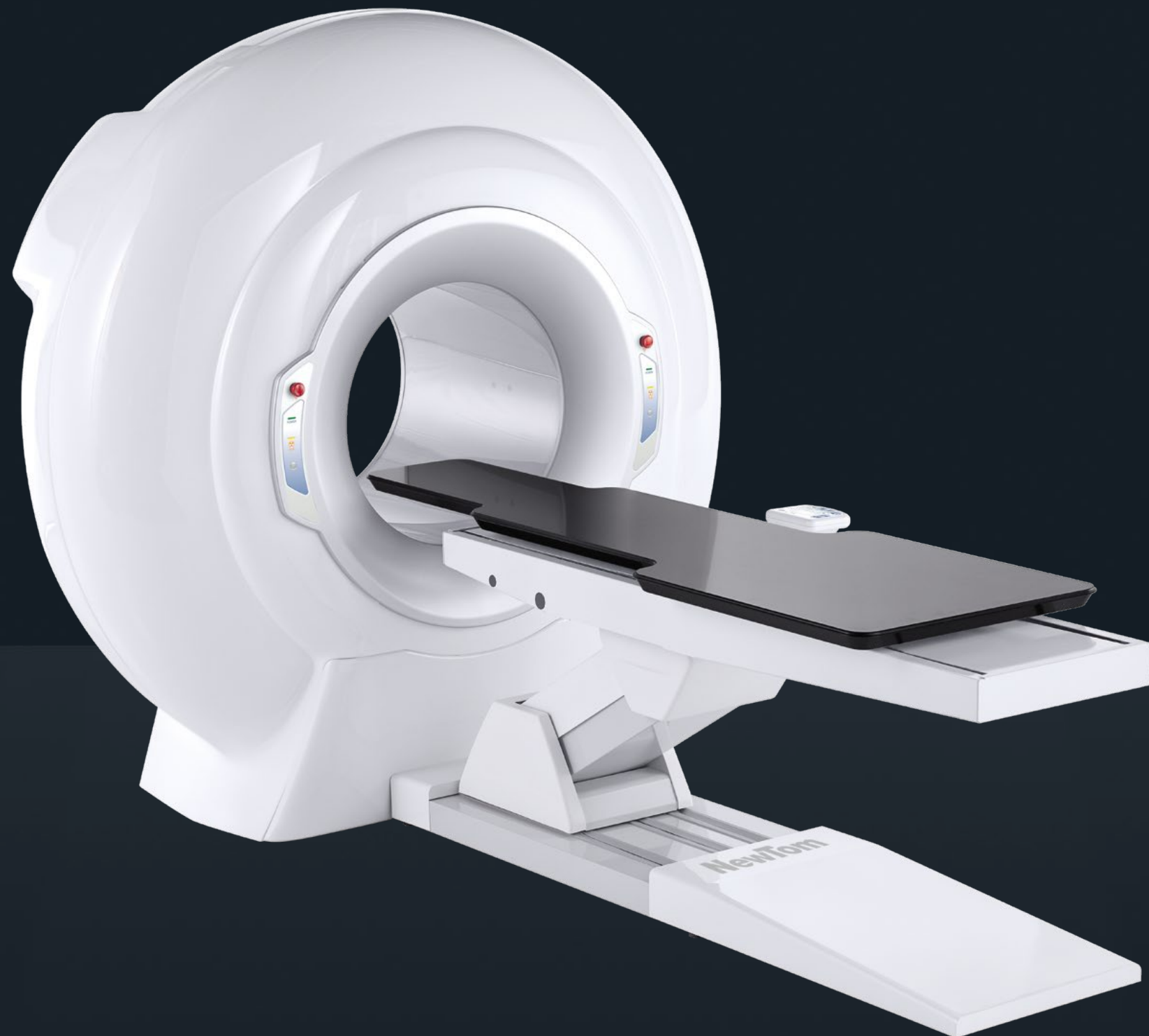

SUPERIOR DIAGNOSTIC QUALITY

Very high resolution 2D and 3D images with a broad range of FOV for an extensive selection of clinical applications.



OPTIMAL LYING DOWN POSITION

The only CBCT system with patient lying down positioning, a motor-driven patient table and an open gantry. Perfect patient stabilisation considerably reduces any movement-induced artifacts.



LOW X-RAY DOSE

The ECO Scan mode and SafeBeam™ technology offered by 5G XL further reduce the dose radiated to the patient, compared to examinations performed with CT technology.



SPECIALIST SOFTWARE

The adaptive user interface displays images and provides access to innovative 3D and 2D analysis functions for rapid and accurate diagnoses and optimal workflow.

UNCOMPROMISING QUALITY.

Superior standard 3D examinations with a device designed for excellent performance.

High definition volumetric images of bone tissue with a "native" isotropic voxel, non-overlapping sections and fewer artifacts. With CBCT technology, 5G XL offers faster examinations and low doses of radiation with greater safety for the patient, better performance and an increasingly efficient workflow.

The high quality images generated by 5G XL are ideal for multiple medical fields, such as dental-maxillofacial diseases, otorhinolaryngology applications, complete analysis of upper airways and precise examinations of bones and joints, limbs and the cervical spine.

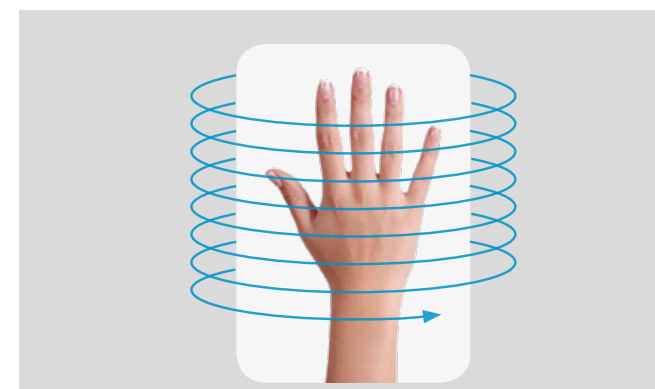

MSCT X-Ray Fan Beam

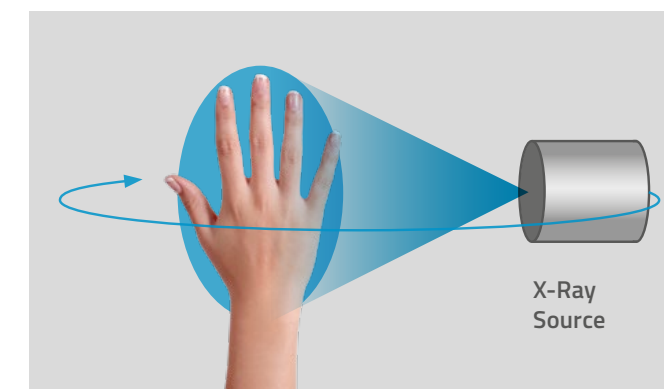

CBCT X-Ray Cone Beam

THE CONVERGENCE OF TECHNOLOGY, PERFORMANCE AND SAFETY

- The powerful generator with rotating anode and smaller focal spot optimises performance, adapting the emission to the specific needs of the examination.
- A large flat panel sensor with a high signal-noise ratio improves image quality, expanding 3D and 2D diagnostic capacity.
- Innovative volumetric reconstruction algorithms control the "image chain" and enhance diagnostic potential, while minimising the presence of artifacts.
- The exceptional user-friendliness makes 5G XL the ideal choice for many image acquisition protocols, such as Ray2D examinations, the study of joint dynamics with CineX protocol, and very high resolution 3D diagnostics to examine bone tissues.



360° reconstruction

The 360° scan acquires the entire volume with a single rotation. 5G XL rapidly generates a complete dataset of axial, coronal and sagittal images as well as 3D renderings.



eXtra FOV Vision

The innovative eXtra FOV function allows to examine longitudinal anatomical parts. FOV 3D can be set from a minimum of Ø6 x h6 cm, up to a maximum native diameter of 21 cm or a height of 22 cm.



HiRes analysis

Clear and detailed very high resolution images to see bone micro-fractures or examine anatomical districts with micrometric details.

OPTIMAL LYING DOWN POSITIONING.

User-friendliness, maximum stabilisation and quality for diagnoses using new medical applications.

5G XL is the only CBCT device available on the market with patient in a lying down position. The motor-driven patient table made of carbon fibre, which can be controlled from the on-board console or from the PC, allows to adapt the examination to any image acquisition need with patient lying down in a prone or supine, cranial-caudal or caudal-cranial position. The open gantry facilitates access to the scanning area and eliminates any sensation of claustrophobia and anxiety. Upper limb examinations are performed with the patient seated on the opposite side of the table.

The lying down position is ideal for sedated, post-surgery and traumatised patients and to study sleep apnea. Reconstructed images are less subject to movement-induced artifacts and examination does not require the use of securing devices, thus ensuring better patient comfort.



ASSISTED ALIGNMENT

The operator directly performs assisted alignment from the workstation via two scout images for automatic adjustment of the motor-driven patient table.



The positioning and lock device has been specifically designed for the various dental and medical disciplines.



The on-board console offers a user-friendly interface to easily move the patient table along three axes, and to activate the alignment lasers by defining the exact reference points of the area of interest.



LOW X-RAY DOSE.

Wellbeing and safety are central to NewTom research.

CBCT technology, compared to MSCT examinations, offers superior diagnostic quality for bone tissue with a much lower radiated dose. Exposure comparable to two 2D X-rays (AP and LL) generally needed for a preliminary examination*.

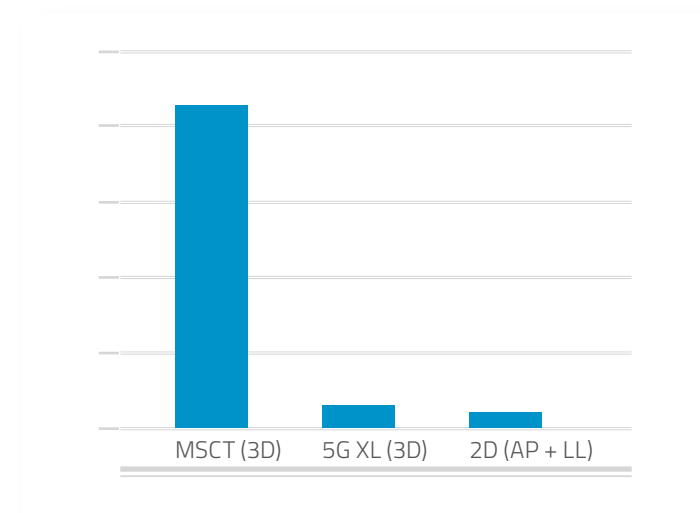

*Koivisto et al. "Effective radiation dose of a MSCT, two CBCT and one conventional radiography device in the ankle region", Journal of Foot and Ankle Research (2015) 8:8.

5G XL offers high standard results with low radiation dose for the patient and exceptional performance as a result of unrivalled top-notch features:

- the **high power generator** improves filtration that protects against the more harmful low-energy radiations;
- X-ray emission occurs in **pulsed mode** during the scan for an extremely limited time, from a minimum of 0.9 s to a maximum of 5.4 s;
- finally, **variable collimation** limits exposure to regions of interest only.



ECO Scan

Low emission up to 0.9 seconds of emission for standard examinations. The ECO Scan protocol is ideal for post-surgery follow-ups and paediatric applications.



SafeBeam™

The exclusive SafeBeam™ technology eliminates the risk of exposing the patient to an unnecessarily high dose by automatically adapting radiation levels to suit the patient's anatomical characteristics.



Ray2D

The Ray2D function allows to perform a preliminary low dose 2D X-ray examination, which can be followed, if necessary, by a high resolution 3D examination only of the area of interest, for in-depth diagnostics.



APPLICATION FIELDS.

With 5G XL, NewTom uses CBCT technology for new medical applications.

Very high quality 2D and 3D images with a broad range of FOVs and dedicated software.

An extraordinary potential for accurate diagnosis in all situations.

ORTHOPAEDIC APPLICATIONS.

Images generated by 5G XL, with their high resolution and quality, allow an in-depth study of the upper and lower limbs not only to diagnose fractures, dislocations, luxations or misalignment but also to define the bone and joint structure resulting from pathological alterations, to detect small bone fragments and to assess diseases in small joints, even when metal screws are present.

Excellent acquisitions that exceed the limitations of CT examinations or those typical of 2D image acquisitions, in which a dedicated visual alignment cannot always prevent overlapping bone structures, thus generating a negative initial diagnosis even in cases presenting a high suspicion of fractures.

5G XL offers perfect 3D images during post-surgery follow-up in the framework of osseointegration of prostheses, plates and bone implants, and in monitoring the healing status even with external immobilisation systems, such as, for example, plaster cast, splints or metal anchoring devices.

UPPER LIMBS

Diagnosis of traumas with evidence of micro-fractures and follow-up treatment.

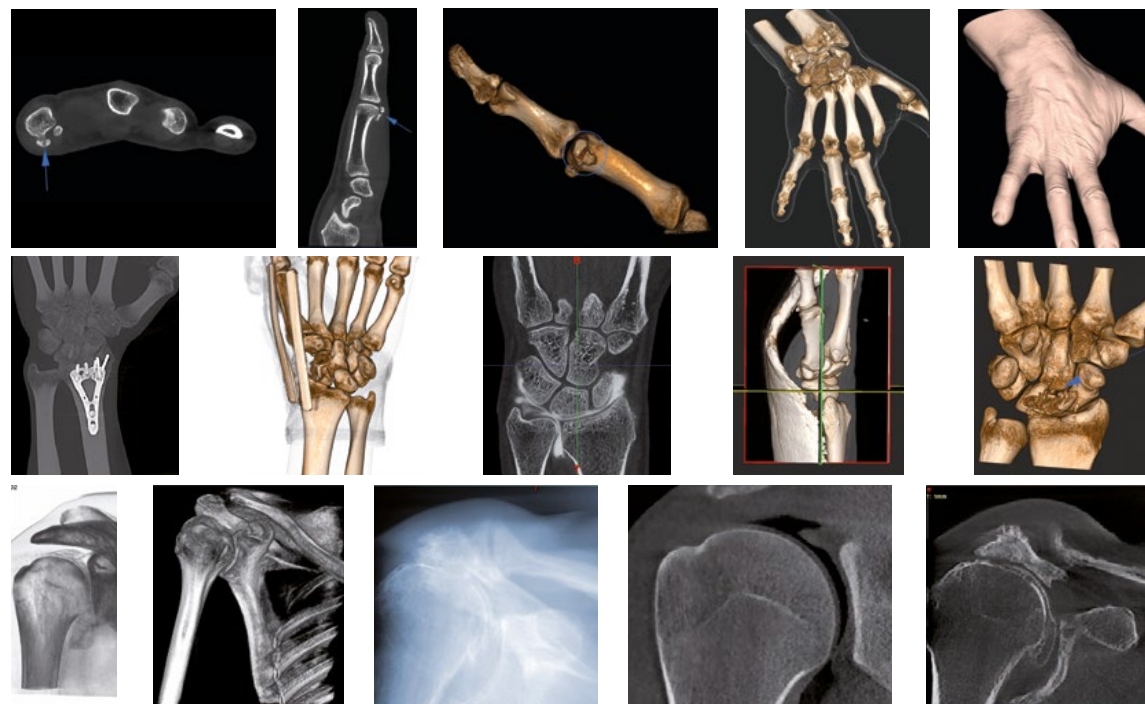

LOWER LIMBS

Planning and post-surgery assessment of implants, plates or prostheses.



HEAD&NECK APPLICATIONS.

INVESTIGATING NECK PAIN

The better spatial resolution of CBCT, compared to MSCT, allows detailed analyses of trabecular and cortical structures to identify any dysplastic, inflammatory, traumatic or micro-traumatic elements. Relationships between vertebral bodies are also perfectly legible, thus highlighting any distortion or subluxation. 3D volumes generated with 5G XL are ideal to examine the atlanto-occipital joint and in surgical programming for the application of osteosynthesis devices and prosthetics.



PLANNING AND VERIFYING MAXILLOFACIAL SURGERY

5G XL generates the entire maxillofacial area within a single scan to verify the presence of fractures or other pathologies, characteristics of the bone and dental arches and the impact of dentition and its roots on both the mandibular canal and the maxillary sinuses. An essential tool for precise planning of surgical treatment and for post-surgery follow-up. Indeed, the presence of metal elements does not impact image quality as a result of innovative filters and the small quantity of radiation, which reduces the scattering effect to a minimum.



UPPER AIRWAY EXAMINATION

With dedicated FOVs, 5G XL can generate the maxillary and frontal sinuses, nose and upper airways within a single scan, thus enabling the diagnosis of otorhinolaryngology diseases, such as sleep apnea (OSA). The analysis software offers dedicated tools for volume measurements, thus facilitating identification of the most critical shrinkage situations. 5G XL is the only CBCT device that allows this examination to be performed with the patient in a lying down position.

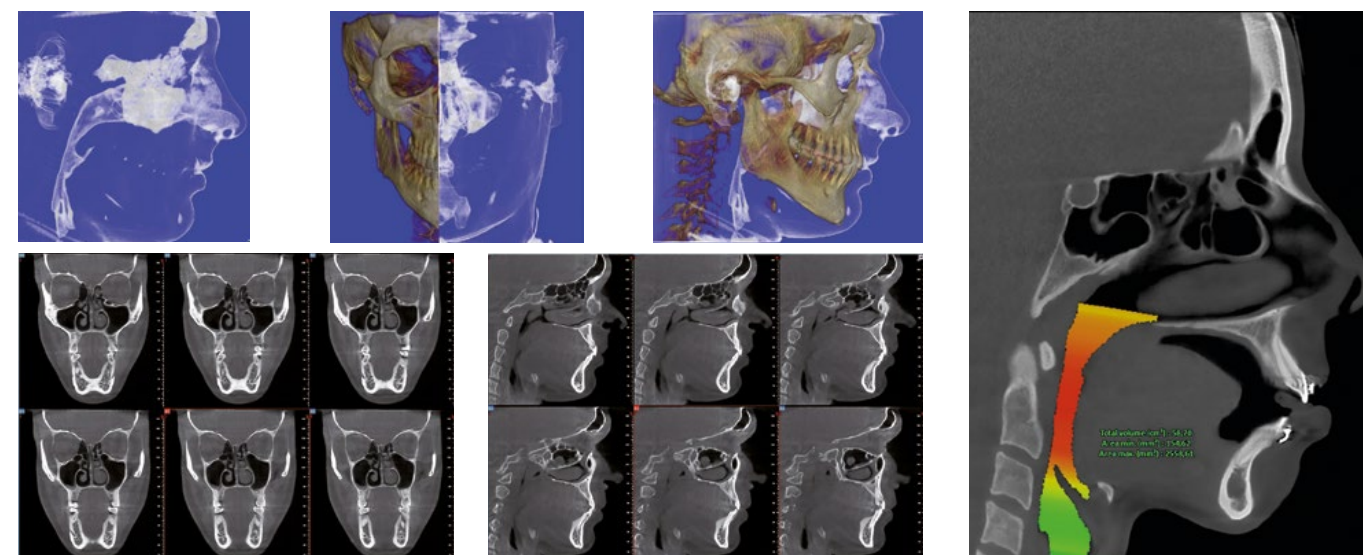

INTERNAL EAR EXAMINATION

Several studies show that CBCT images perfectly identify implant position both in the round window and the incus. This examination exposes the patient to fewer risks of exposure to ionising radiations; hence, it is preferable for middle ear implant follow-up examinations. NewTom's exclusive SafeBeam™ technology also allows to expose the patient only to the necessary dose.

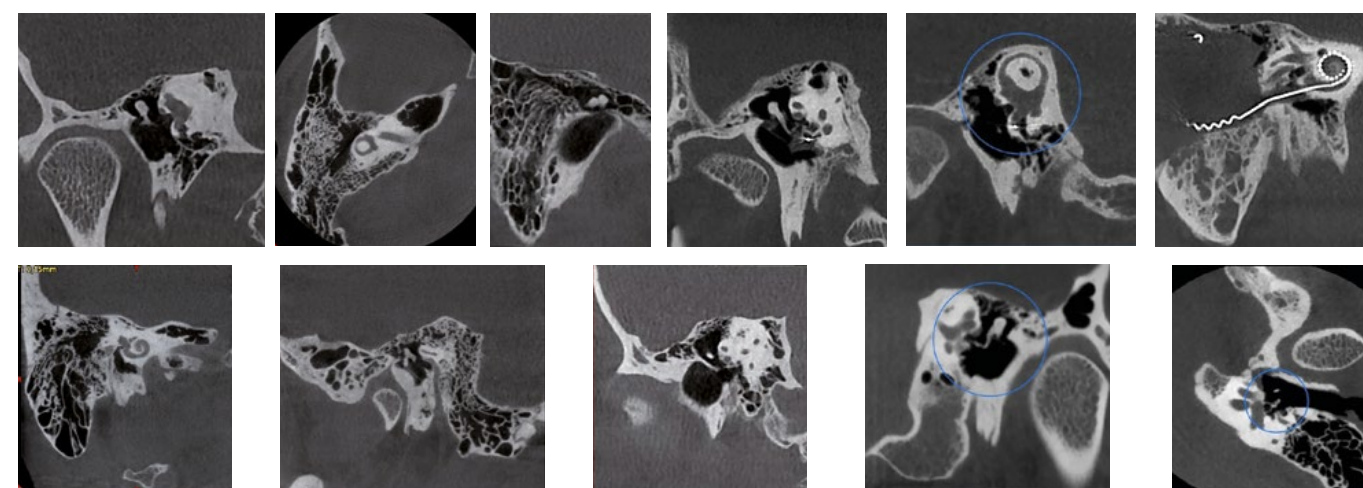

HEAD&NECK APPLICATIONS.

TEMPOROMANDIBULAR JOINT (TMJ) EXAMINATION

Diagnosis and anatomical assessment of the temporomandibular joint can be performed with high quality 3D images generated by 5G XL. Sagittal and coronal slices provide optimal imaging of the joint zone to identify any pathologies and to assess the difference between condyle height and the mandibular branch.

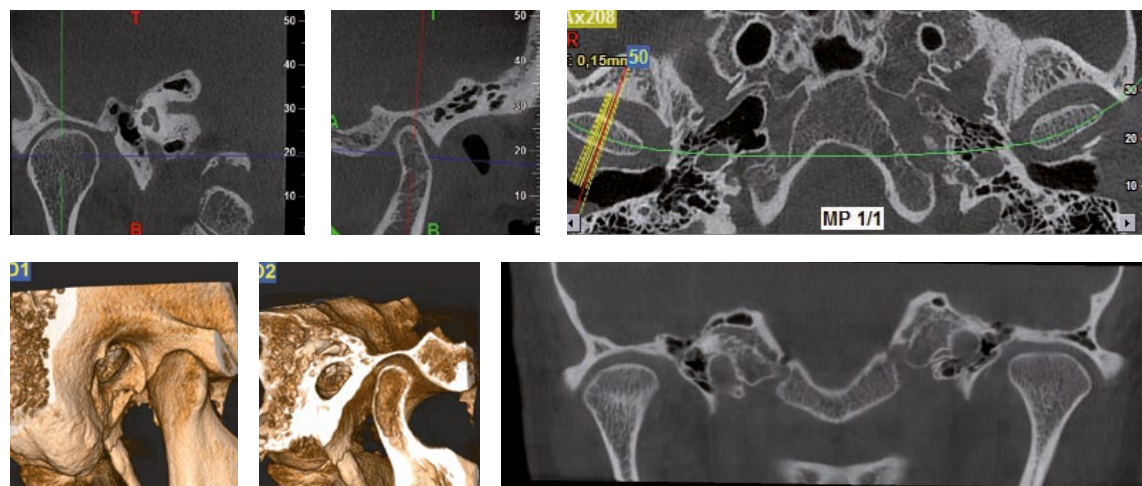

ORTHODONTIC ANALYSIS

The ideal application for tomographic, panoramic and cephalometric images acquired with 5G XL is in examinations for aesthetic and orthodontic purposes and for the treatment of severe diseases. The realistic image provided by 3D examinations, compared to 2D diagnostics, allows to modify the visual angle and to adjust the thickness of reconstructed sections. Hence, the mutual position of dental elements and relations with the surrounding anatomical structures can be precisely assessed. These functions are essential to plan treatment, especially in the event of supernumerary and/or impacted teeth.

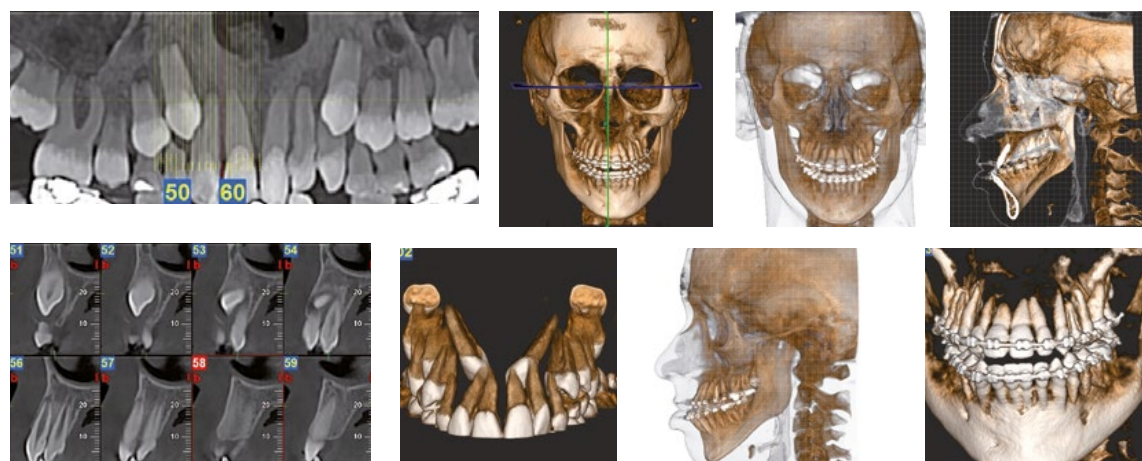

ENDODONTIC AND PERIODONTIC EXAMINATIONS

5G XL is a particularly effective device to assess apical lesions, plan fractured tooth treatment and mandibular canal therapy, and treat tissue adjacent to the tooth. In fact, the detailed images generated by the device are very useful for endodontic therapy and periodontic examinations. To protect patient safety, FOV size can be adapted to the region of interest.

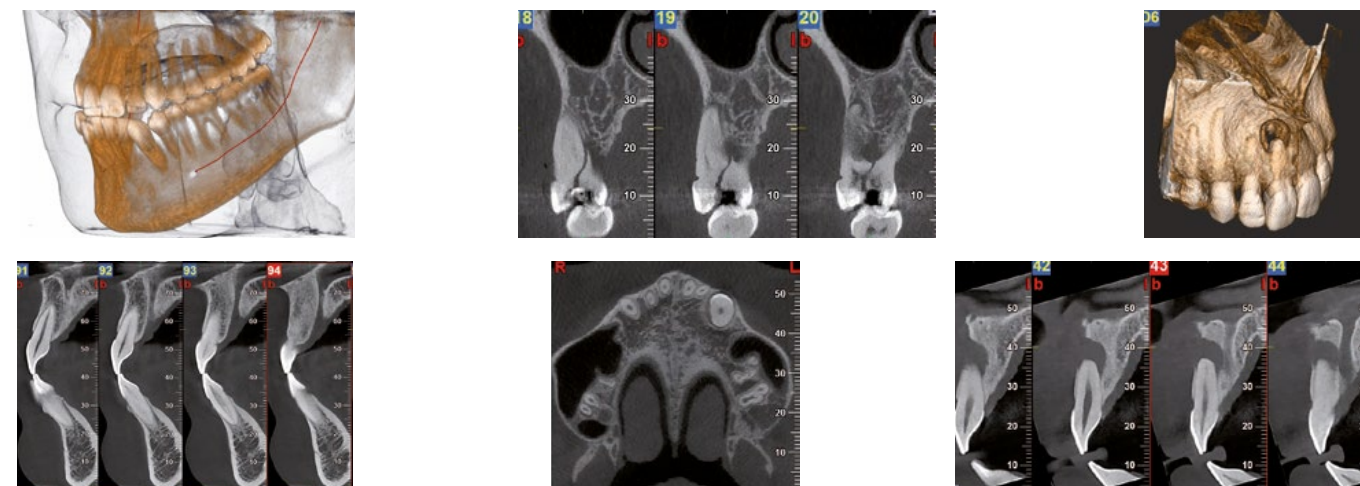

DEFINITION AND CONTROL OF ORAL IMPLANT SURGERY

Volumes obtained with 5G XL are a highly effective tool to plan implant surgery, perform a realistic assessment of the site and choose the implant. Sizes in a 1:1 scale and detailed images of surrounding bone quality provide precise implant positioning indications. The simulation can be displayed on 3D rendering, and specialised 3D software can be used to precisely plan prosthetically guided implant surgery and customise the surgical template. Follow-up examinations will allow necessary assessments on the osseointegration process rate and on rejections, if any.

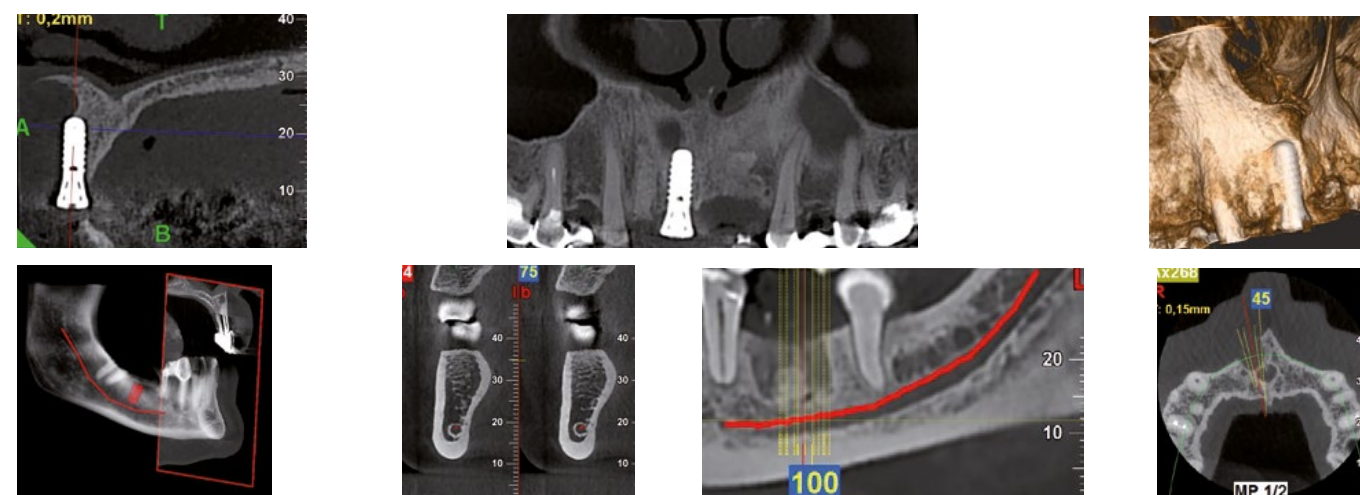

NNT, THE SOFTWARE FOR ALL SPECIALIST NEEDS.

The versatile and powerful imaging software to perform the examination, process data and share the diagnosis.

NNT is the essential tool to process and manage 2D and 3D images and X-ray videos (CineX). A software that adapts the user interface and offers dedicated analysis functions for the specific needs of radiologists and specialist physicians.

Volume reconstruction algorithms and advanced filters created by NewTom's experience optimise final image quality and reduce the presence of artifacts and time required for image reconstruction.

3D volumes, 2D images and videos processed with the CineX function, which are compatible with DICOM 3.0 (IHE) standard, can be easily shared via the NNT Viewer version or printed on a 1:1 scale through customisable reports.



DENTISTRY: CROSS SECTIONS IN PANORAMIC IMAGES

Complete examination of the dental arches in cross sections to check shape, size and status of maxillary and mandibular bones and teeth.

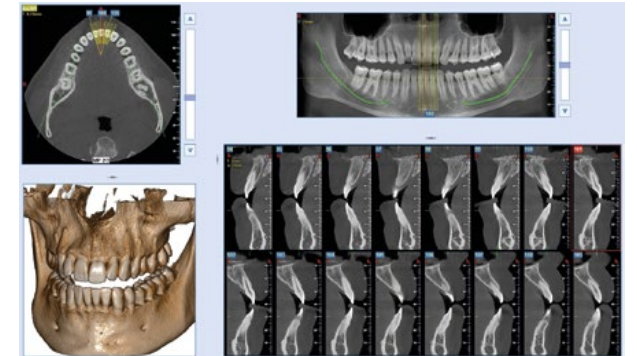

OTORHINOLARYNGOLOGY: FREE MULTIPLANAR SECTIONS

Dynamic high resolution examination of the internal ear along non-orthogonal planes is essential to diagnose any diseases of the ossicular chain, stapes' base, semicircular canals, cochlea and adjacent structures.

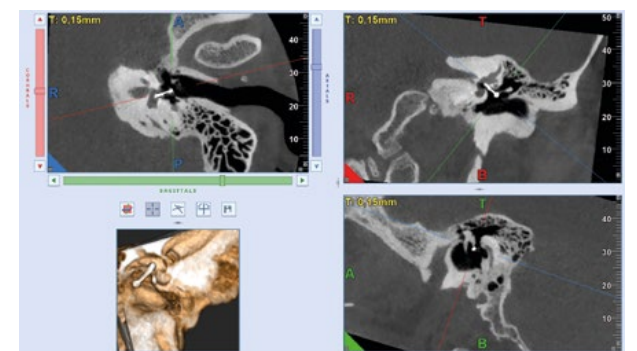

GNATHOLOGY: DUAL TMJ VISION

Simultaneous examination of both temporomandibular joints; symmetrical analysis and detection of problems or dysfunction deriving from joint diseases.

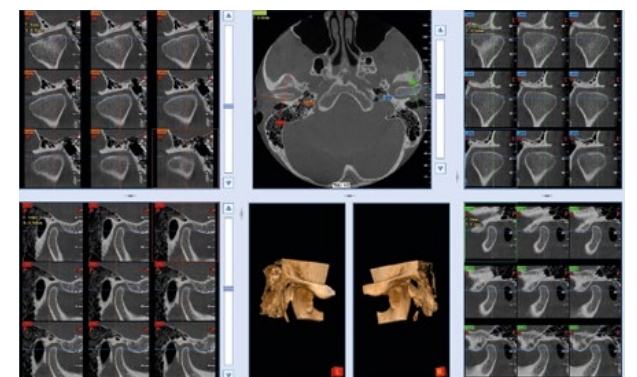

RADIOLOGY: MULTI-SLICE EXAMINATION

Examination of multiple image samples in Med-Like style with personalised orientation for the various assessments of anatomical areas scanned.

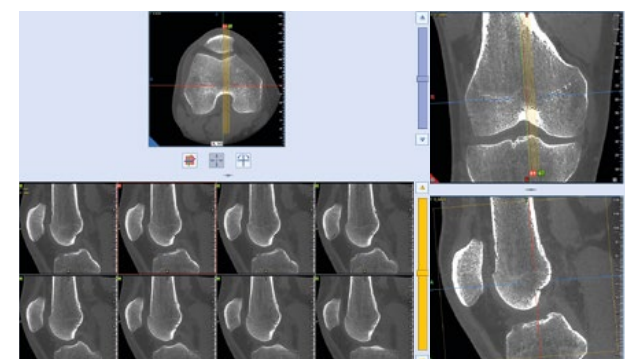

SPECIALIST TOOLS.

Ray2D

With the innovative Ray2D function, 5G XL generates 2D X-ray images (18 x 19 cm) that are perfect for both preliminary and post-surgery follow up examinations. It is possible to repeat the investigation from various angles to select the image with the best perspective.



CineX

5G XL offers the exclusive CineX function to investigate moving anatomical structures, such as saliva ducts and joint mobility. This advanced technology uses a sequence of X-ray images to create an 18 x 19 cm format video that can also be exported to standard video format.

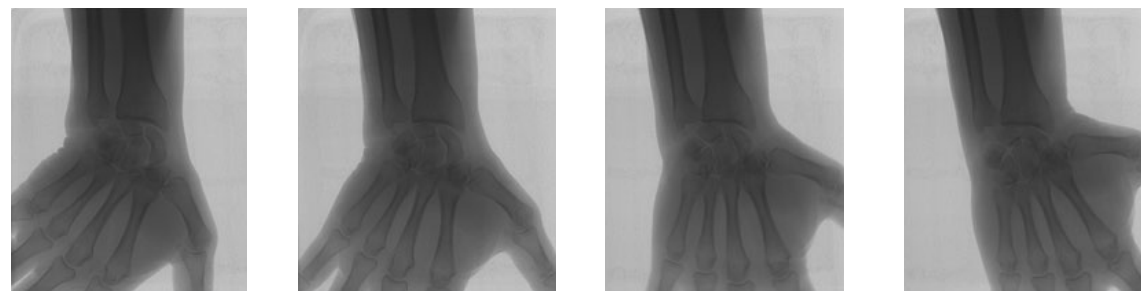

IMPLANT SITE ASSESSMENT

Estimates bone density in a potential implant site, with Misch scale classification, to correctly plan treatment.

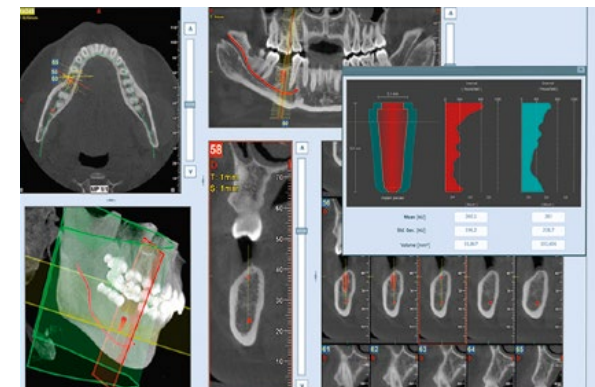

AIRWAY VOLUME ANALYSIS

Estimating the actual upper airway space is essential to diagnose respiratory diseases and sleep apnea (OSA).

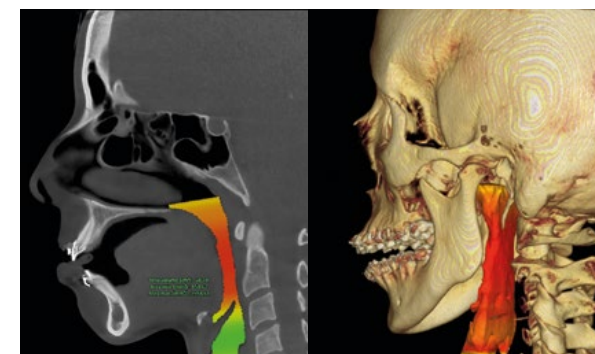

2D AND 3D EVALUATION

The possibility to evaluate distances on 2D sections or with 3D rendering to verify any joint problems.



ADVANCED REPORTS

Advanced draft of medical reports to share on PACS, also available in automatic compiling mode.

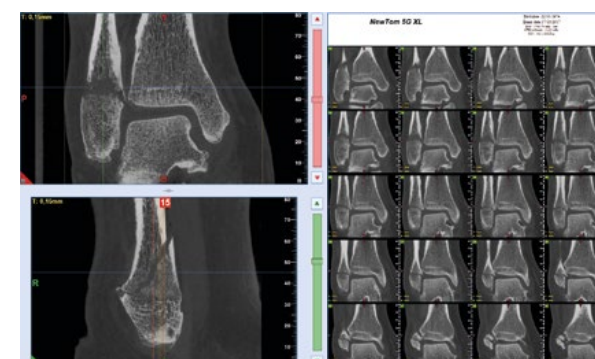

COMPLETE CONNECTIVITY.

Excellent connectivity and integration with the modern systems adopted by NewTom. Workflow and clinical and diagnostic activities become much easier and highly performing.

REMOTE ASSISTANCE

By appropriately configuring the device to use the surgery's Internet connection, technical support can be provided from remote, and device status can be monitored.

3D/2D VIEWER

Examinations can be shared with colleagues and patients by providing the Viewer directly on CD, DVD or a USB storage device.

1:1 PRINT

Complete and flexible report for storing and sharing colour reports on photographic paper or grey scale reports on X-ray-equivalent transparencies.

OTHER ACQUISITION DEVICES

Compatibility with TWAIN standard and DICOM 3.0, guarantees the NNT software management of images from other 2D/3D image acquisition devices, such as video cameras, sensors, PSP and CBCT scanners.

MULTI-STATION DISPLAY AND PROCESSING

Image storage on a shared database in a local network that can be accessed from any workstation and iPad (only 2D). Management of multiple archives and access to password-protected data.

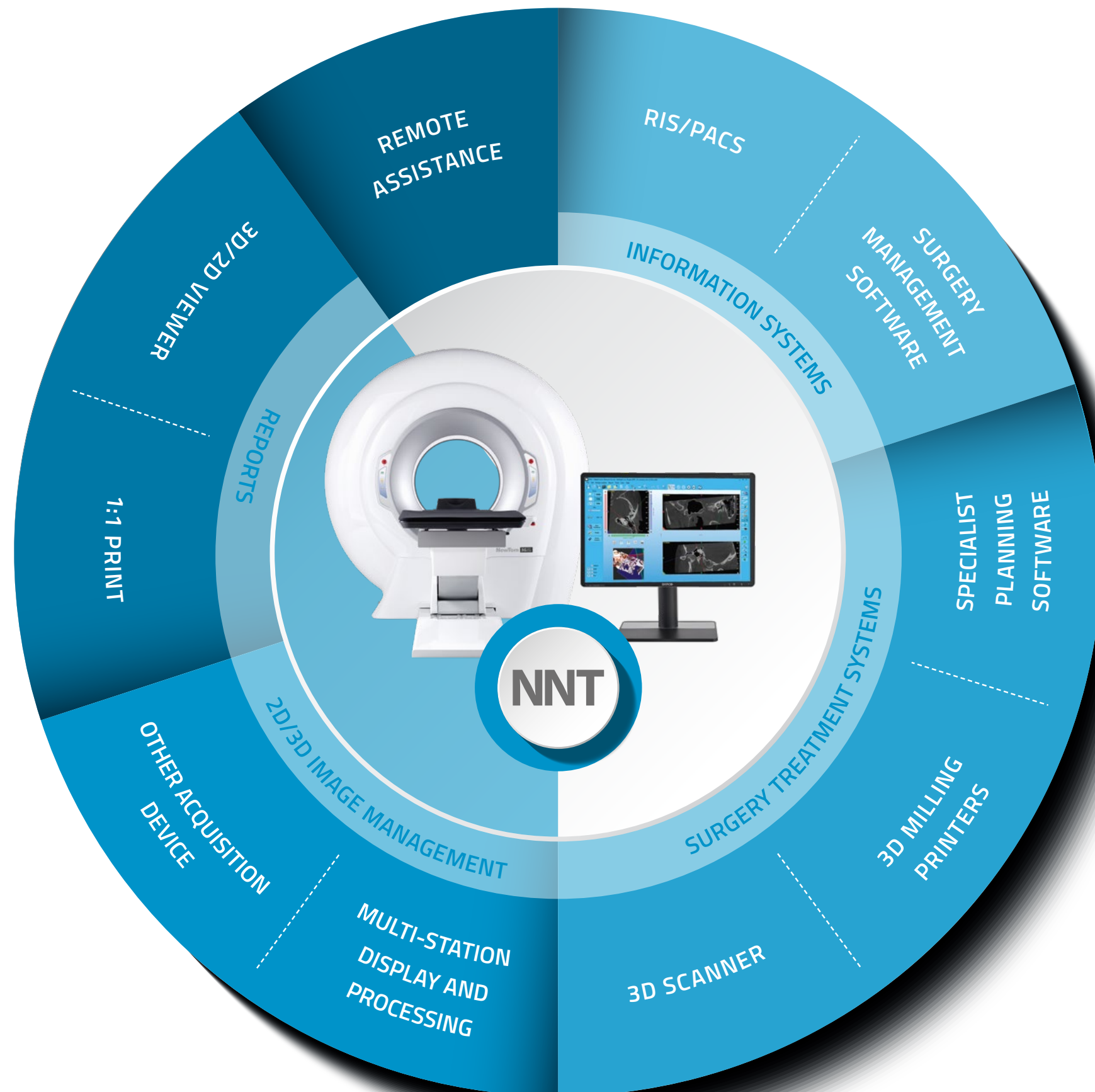

RIS/PACS

IHE compliant system that allows communication with RIS/PACS systems and DICOM printers. Complete services available: Print, Worklist, Storage Commitment, MPPS and Query/Retrieve.

SURGERY MANAGEMENT SOFTWARE

An open system designed for fast, efficient interfacing with the main dental surgery management software solutions via various standard VDDS, TWAIN and/or proprietary NNTBridge modes.

SPECIALIST PLANNING SOFTWARE

Exports in DICOM 3.0 format to specialist planning software to process orthodontic treatments, prostheses, implants, orthognatic and maxillofacial surgery.

3D MILLING PRINTERS

Software modules are available to segment the reconstructed volume and export to STL format the surfaces required to create 3D models that can underpin planning and treatment.

3D SCANNER

Prosthetically guided planning by integrating (via the dedicated software module) data in STL format from optical, intraoral or laboratory scanners, with volumetric data.

TECHNICAL SPECIFICATIONS.

| | |
|----------------------|---|
| X-ray source | High frequency generator, rotating-anode X-ray tube |
| Focal spot | 0.3 mm |
| Exposure Control | SafeBeam™ to reduce exposure according to patient build |
| Sensor | Amorphous silicon flat panel |
| Grey scale | 16-bit |
| 3D scan time | 18 - 36s |
| 3D emission time | 0.9s - 9.0s (single scan) |
| 3D image acquisition | Single scan with Cone Beam technology. 360° rotation |

| Available FOV Diameter x Height | Resolution | | Selectable 3D scan modes | | | |
|------------------------------------|------------|-------|--------------------------|---------|---------|----------|
| | Standard | HiRes | Eco | Regular | Boosted | Enhanced |
| 21 x 19 cm | ■ | | ■ | ■ | ■ | ■ |
| 18 x 16 cm | ■ | | ■ | ■ | ■ | ■ |
| 15 x 22 cm eFOV | ■ | | ■ | ■ | ■ | ■ |
| 15 x 12 cm | ■ | | ■ | ■ | ■ | ■ |
| 15 x 5 cm | ■ | ■ | ■ | ■ | ■ | ■ |
| 12 x 8 cm | ■ | ■ | ■ | ■ | ■ | ■ |
| 10 x 10 cm | ■ | ■ | ■ | ■ | ■ | ■ |
| 10 x 5 cm | ■ | ■ | ■ | ■ | ■ | ■ |
| 8 x 8 cm | ■ | ■ | ■ | ■ | ■ | ■ |
| 8 x 5 cm | ■ | ■ | ■ | ■ | ■ | ■ |
| 6 x 6 cm | ■ | ■ | ■ | ■ | ■ | ■ |

| | |
|--------------------------------|---|
| Selectable voxel size Standard | 200 - 300 μm |
| Selectable voxel size HiRes | 100 - 150 μm |
| Reconstruction time | Less than 1 minute |
| Ray2D image acquisition | Digital Radiography (single shot, position selectable by user) |
| CineX image acquisition | 1-36s Serial Radiography, field of view 18x19 cm (WxH) |
| Patient positioning | Seated or lying down, prone or supine, in cranial-caudal or caudal-cranial position |
| Weight | 660 Kg |
| Software | NewTom NNT with Viewer software, free |
| DICOM nodes | IHE compliant (Print; Storage Commitment; WorkList MPPS; Query Retrieve) |
| Power supply | 15A @100/115 V~, 12A @200 V~, 10 A @220/230 V~, 8A @240 V~, 50/60 Hz |

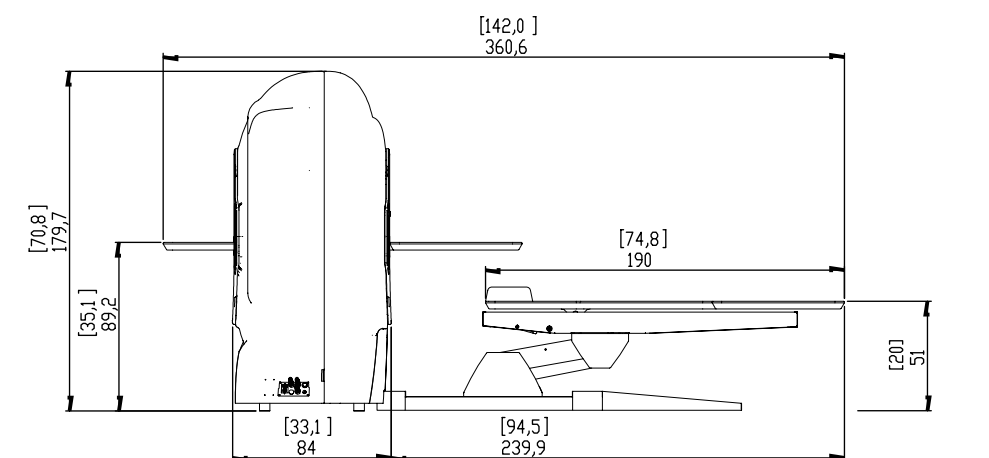

Dimensions in centimetres
(dimensions in inches)

