

NICE GLASS

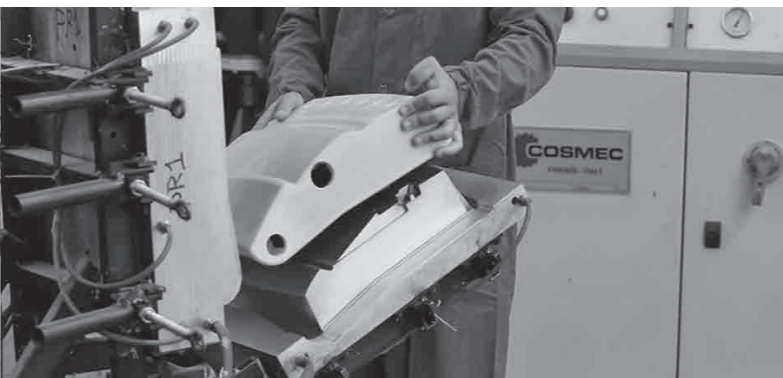

RELIABILITY AND TECHNOLOGY,
ADAPTABLE TO EVERY SINGLE STYLE.

miglionico
DENTAL EQUIPMENT



MIGLIONICO, AN ALL ITALIAN STORY.

WE CAREFULLY SELECT THE BEST RAW MATERIALS AND TRANSFORM THEM TO CREATE OUR UNITS. WE WORK WITH PASSION AND COMMITMENT TO GUARANTEE QUALITY AND RELIABILITY OVER TIME.



Internal production

Our highly specialized staff, through the use of the most innovative software and mechanical technologies, create the units from the design to the quality control. We have CAD / CAM machines, laser cutting machines, press bending machines, numerical control lathes, polyurethane molding devices and welding devices. The internal and direct management of the entire production allows us to offer excellent products while remaining very competitive and versatile.



High quality materials

The key to quality lies in the choice of excellent materials. We combine innovation and solidity to guarantee reliable and resistant products. We only use excellent materials, such as aluminum and iron for the internal structure, painted polyurethane for external surfaces, glass for the display pannels and skay leather for the upholstery. Our goal is to offer you a solid product, easy to manage and sanitize, to make our units last over time.





NICE GLASS

RELIABILITY AND ADAPTABLE TECHNOLOGY
FOR EVERY SINGLE STYLE

TECHNOLOGY AT THE SERVICE OF FUNCTIONALITY AND SAFETY. SIMPLE AND VERSATILE IN USE, THANKS TO ITS CHARACTERISTICS IT GUARANTEES HIGH QUALITY STANDARD PERFORMANCE AND MAXIMUM HYGIENE.





OPERATOR SIDE

Everything, right at your finger tips

The operator control panel is adjustable and is equipped with an integrated negatoscope (X-ray film viewer). Thanks to its movement, it is possible to have the right view and the most convenient access of the display both while working in the standing up or in the seated position. The multifunction display with capacitive touch technology has a glass surface and is encapsulated in a painted polyurethane structure.

Giving space to your needs

The operator side is designed to guarantee maximum ergonomics and ease of handling. The arm has a wide excursion that allows you to position the operator console in the most functional working position, while still maintaining its reduced dimensions. The console, designed to accommodate up to 6 instruments, is equipped with an automatic sensor activation when each handpiece is withdrawn from its position and a removable and autoclavable silicone instrument mat.

Self-balanced arm with automatic lock.

Extendable hoses up to 96cm which are self-balancing and without traction in the SPRIDO (top delivery) version.

Operator console in polyurethane and pre-disposed to accommodate 6 instruments.

Stainless steel tray holder which has a 360° rotation. Available in three sizes.

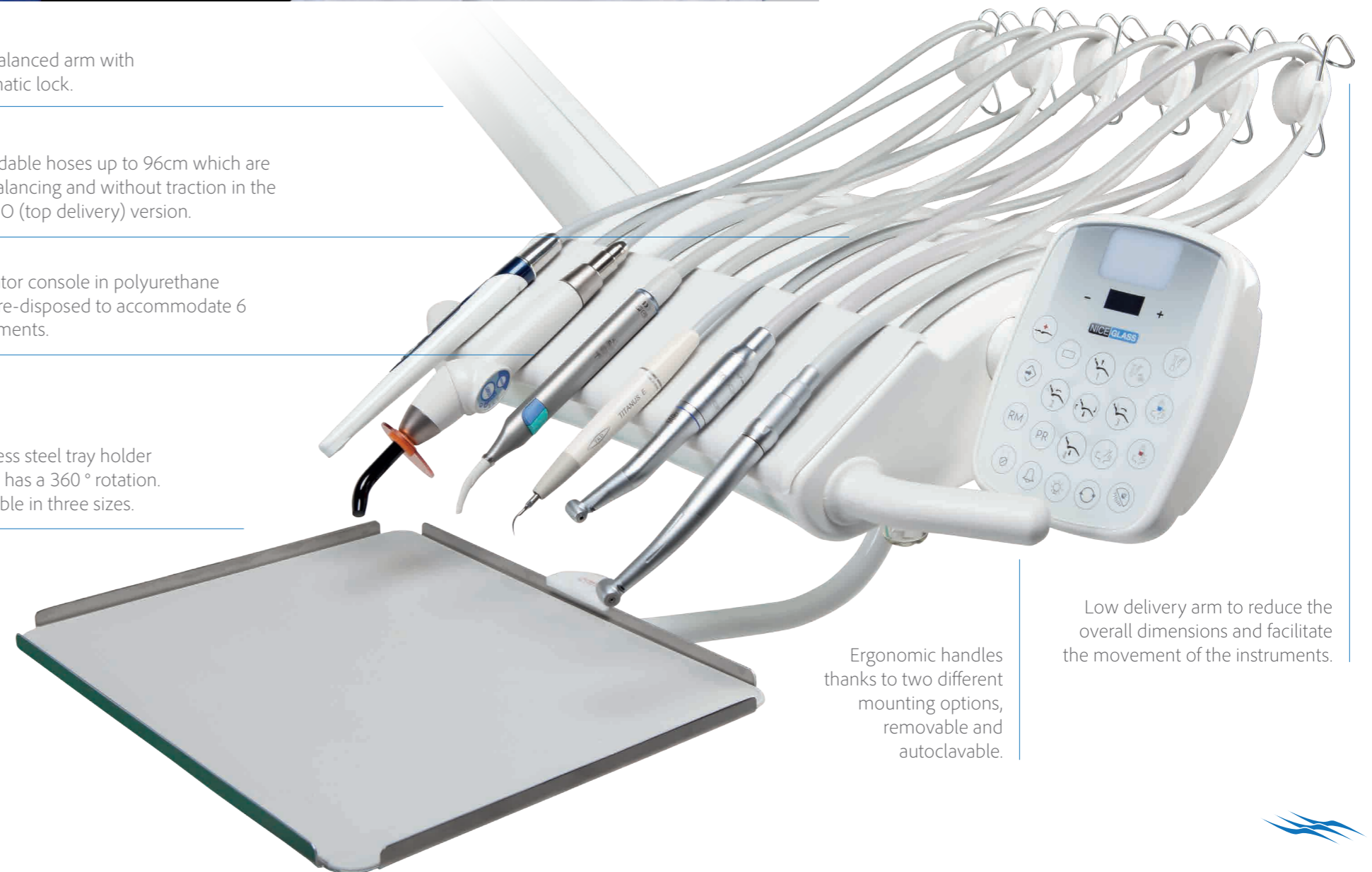

Ergonomic handles thanks to two different mounting options, removable and autoclavable.

Low delivery arm to reduce the overall dimensions and facilitate the movement of the instruments.





Only excellence is chosen

The operator's delivery console pre-disposed for 6 instruments can be customized according to the needs of the operator. All the modules are created in partnership with the main manufacturers of handpieces in the sector to guarantee reliability and technology. The best partners for the best products to offer you.

INSTRUMENTS



BRUSHLESS MICROMOTOR



STAINLESS STEEL SYRINGE

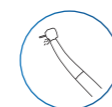

F.O. MIDWEST TURBINE OUTLET



CURING LIGHT



SCALER

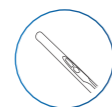

INTRAORAL CAMERA



SECOND BRUSHLESS MICROMOTOR



SECOND F.O. MIDWEST TURBINE OUTLET

- 7 memorizing positions + last memory position
- Chair movement
- Trendelenburg position
- Micromotor speed control and scaler power
- Micromotor inversion
- Peristaltic pump activation



- Water rinse to cuspidor
- On / Off operator lamp
- Fiber optic lamp management
- Assistant call / door opener
- X-ray film viewer
- Activation and timer of hot or cold water to the glass

Simple commands

Managing the unit is simple and intuitive thanks to the glass display icons. With a simple touch it is possible to activate all the functions of the unit and set the desired parameters. Easy to sanitize thanks to the timed lock function.



Movement is freedom

The assistant delivery arm is mounted on a double articulation arm which allows to better manage the work area whether working alone or with an assistant. The possibility of maneuvering the space near the patient and the hydro group, using the convenient handle placed on the delivery arm, allows ample freedom in the movements and in patient assistance procedures. The comfort of the patient in the rinsing phase is in perfect harmony with that of the assistant during work thanks to the cuspidor with 180° rotation. Easy to handle, it is also removable.



The perfect ally

The assistant display console is made of glass with capacitive touch technology: the command keys allow you to manage the unit's functions with a simple touch. The assistant delivery arm is equipped with two cannulas for surgical suction and is designed to accommodate also syringe and curing light. All the instruments are activated automatically and placed on removable and autoclavable supports. The hydro unit is compact and functional thanks to the facilitated movements of both the cuspidor and the upper carter.

Hydro group

Designed to simplify routine maintenance as much as possible, the Nice Glass hydro unit is equipped with a practical slide opening. Simply just rotate the cover to have easy access to the hydro and electronic components, properly separated to guarantee safety and comfort. The technological heart of the unit, it is enclosed in a compact and functional space.

INSTRUMENT CONFIGURATION

STANDARD



SUCTION CANNULAS



OPTIONAL



STAINLESS STEEL SYRINGE



CURING LIGHT



Commands and configuration

The assistant console, intuitive and multi-functional, allows chair movement, activation and timing of hot or cold water to the glass, rinse to cuspidor management, On / Off of the operator lamp and recall of positions. The standard console houses two suction cannulas. It is possible to add an extra two housing for curing light and syringe.



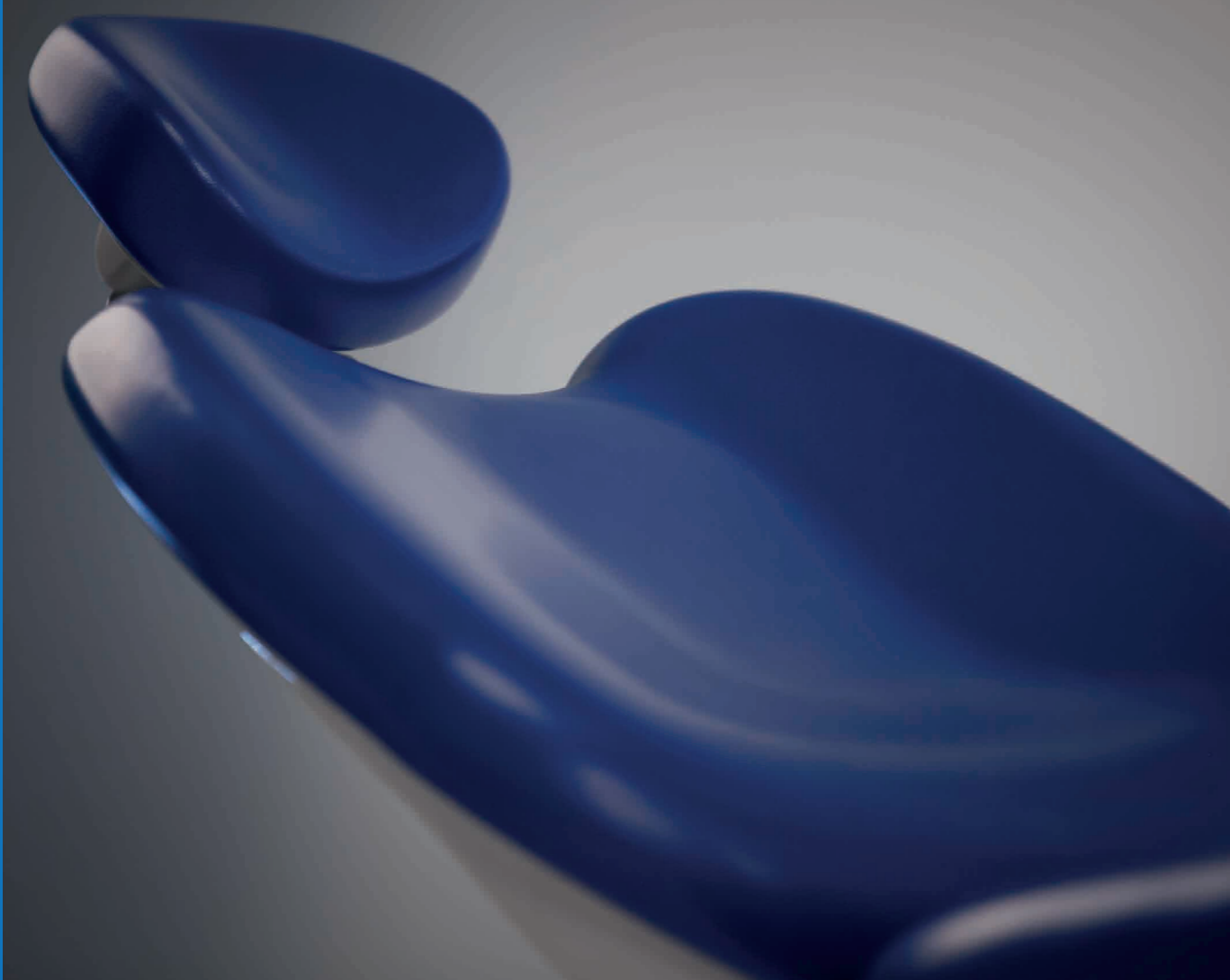

THE BEAUTY OF COMFORT

The details

Small details to improve quality of your work.



HEADREST

Adjustable in height and adjustable on three axes, in skay leather.



ARMREST

The unit is equipped with the comfortable and functional rubber armrest on the left.



WIDE BACKREST

Ideal for those who love working in the 12:00 o'clock position.



SLIM BACKREST

Ideal for those who love working in the 9:00 o'clock position or standing.

The backrests

Ergonomic backrest with lumbar support and depressions designed to guarantee patient comfort and adaptability.

SYNCRO chair

Padded with a soft comfort system and covered in seamless skay eco-leather. The chair has a wide range of operational movements and thanks to the independent and synchronized movement of the back, seat and footrest, it guarantees extreme flexibility. The chair is equipped with 4 anti-crush safety systems.

					
COD. 920 RENOIR	COD. 902 GIOTTO	COD. 904 KOSTABI	COD. 905 GAUDI	COD. 906 KLIMT	COD. 919 BOTTICELLI
					
COD. 909 MATISSE	COD. 908 VAN GOGH	COD. 950 BOTERO	COD. 923 MODIGLIANI	COD. 924 MIRÒ	COD. 910 RAFFAELLO
					
COD. 914 CARAVAGGIO	COD. 922 DALÌ	COD. 915 LEONARDO	COD. 911 MICHELANGELO	COD. 6001 DEGAS	COD. 8017 MONET

Additional colors available upon request.



SEAT PROTECTION PILLOW

Practical and discreet, coordinated with the upholstery, it prevents wear and tear by protecting the leather of the seat.



CHILD REDUCTION PILLOW

Greater comfort even for the little ones. The pillow raises the seat making operation easier.

The Accessories

Protect your dental unit and make it more comfortable for pedodontic patients





VERSATILITY AND ERGONOMICS

SPRIDO
(TOP DELIVERY)
CONFIGURATION



HANGING HOSES
CONFIGURATION



LEFT-HANDED
CONFIGURATION



DENTAL UNIT
+ CART
CONFIGURATION



According
to your style

6 configurations
designed
to adapt to different
work ergonomics.

CART STAND ALONE
CONFIGURATION



SURGERY ROOM
CONFIGURATION



Optimize your
spaces

Reduced dimensions and
large movements make
our dental unit extremely
comfortable to use both
alone as well as with an
assistant.

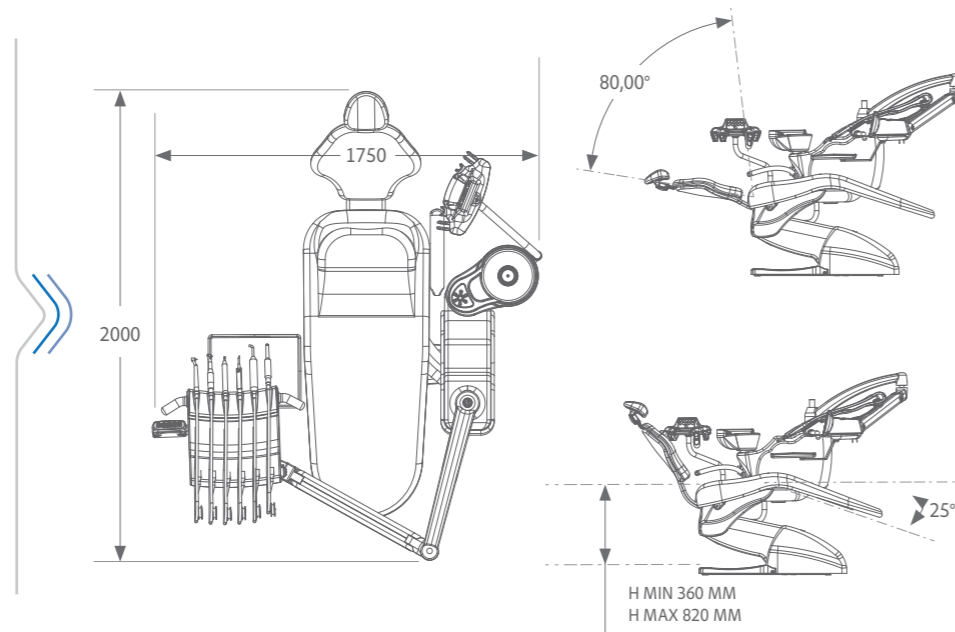

Multimedia Kit

Technology is a valid assistant. Whatever your needs in multimedia, there is a configurable solution. We can offer flexible and customized solutions for integrated multimedia systems.



Operating Lamp

For our lamps, a partner of excellence, choose between the halogen or LED technology, which Faro lamp best suits you.



EDI
Halogen



MAIA
Led 35000 Lux



ALYA/THEIA TECH
Led 50000 Lux

Multifunction Foot Pedal

A valid ally to manage your unit. Two types of pedals are available: standard and push. Both versions can be Wi-Fi (optional).



STANDARD



PUSH



Stools

Your comfort first and foremost. Stools with anatomic cushions without stitching and in sky leather, with height adjustment and self-braking wheels. Available in four models.



Removable and autoclavable parts

Procedures for disinfection must be simple, fast and effective. Miglionico units are designed to optimize time and guarantee a constant and effective hygiene of the unit.



SILICONE MAT

QUICK RELEASE OPERATOR CONSOLE HANDLES



INSTRUMENT SUPPORT IN RESIN

STAINLESS STEEL TRAY HOLDER

SILICONE TRAY MAT

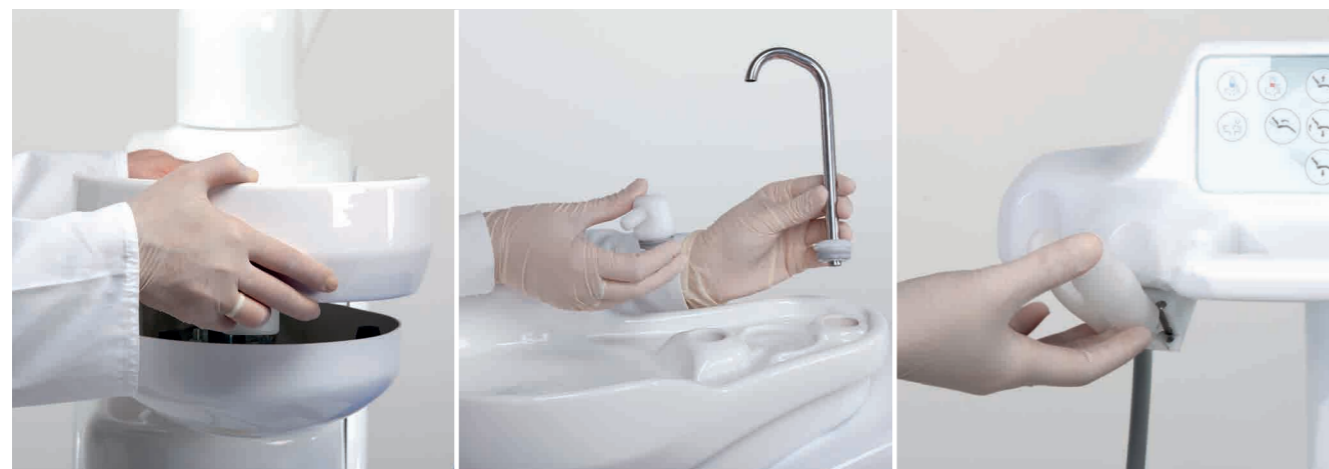

CUSPIDOR*

WATER DISPENSERS IN RESIN AND STAINLESS STEEL

INSTRUMENT SUPPORTS ON ASSISTANT CONSOLE

* Not autoclavable

HYGIENE ABOVE ALL

Active hygiene systems

Choose from the various standard and optional solutions the one best suited to safely support your work.

STANDARD



ANTI-FLUID RETRACTION SYSTEM ON THE HANDPIECES

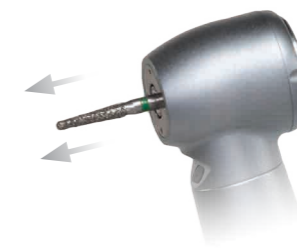

SECURE AIRFLOW SYSTEM OF THE HANDPIECES

OPTIONAL



AUTOMATIC DISINFECTION SYSTEM FOR HYDRO CIRCUITS TO HANDPIECES (MDS) AND INTENSIVE DISINFECTION SYSTEM FOR HYDRO CIRCUITS TO HANDPIECES (MDS+)



PERISTALTIC PUMP SYSTEM FOR EXTERNAL IRRIGATION



INDEPENDENT WATER SUPPLY SYSTEM BY SEPARATE BOTTLE INSIDE THE UNIT + BYPASS

INTEGRATED SUCTION SYSTEMS

WET SUCTION

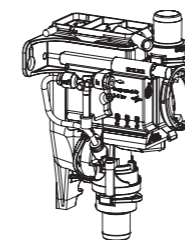

DRAIN CUSPIDOR VALVE

To be connected to the suction motor with integrated separator.

DRY SUCTION

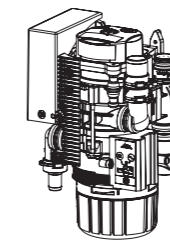

AMALGAM SEPARATOR

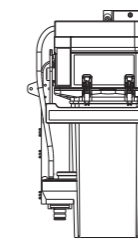

AIR / WATER SEPARATOR

Adaptability to all suction systems

Standard predisposition for Wet suction system and flexibility of the unit to accommodate in built devices in case of Dry suction and to be in compliance with the European Amalgam separation regulation.



miglionico

DENTAL EQUIPMENT



CUSTOMIZE
YOUR
UNIT



MIGLIONICO s.r.l.
Acquaviva delle Fonti (BA) - Italy
Phone (+39) 080 759552
Info@miglionico.net

To discover our product range
and all our accessories,
visit our website
www.miglionico.eu

