

A close-up photograph of an elephant's head, split vertically down the middle. The left side is illuminated with a warm, golden light, while the right side is in a cool, greyish light. The elephant's trunk is visible in the center, extending downwards. In the lower-left quadrant, there are several thin, golden, curved lines that sweep across the image.

**R E G
E N E
R A T
I O N
M A T
E R I
A L S**



B&B DENTAL
IMPLANT COMPANY



INDEX

COLLAGEN T-BARRIER MEMBRANES

COLLAGEN T-BARRIER MEMBRANES.....	4
KEY PROPERTIES - COLLAGEN T-BARRIER MEMBRANES	5

NOVOCOR

NOVOCOR.....	6
KEY PROPERTIES - NOVOCOR	7

TITANIUM T-BARRIER MEMBRANES

TITANIUM T-BARRIER MEMBRANES	8
OSTEOSYNTHESIS SCREWS	9

CLINICAL CASES

AESTHETIC-FUNCTIONAL RESTORATION IN FRONTAL POST-EXTRACTION SITE.....	10
IMPLANT WITH COMPLETE ABSENCE OF VESTIBULAR LAMELLAE - FOLLOW-UP AT 7 YEARS	11
VERTICAL BONE VOLUME RESTORATION	12
TISSUE MAINTENANCE IN POST-EXTRACTION SITE FOR DELAYED LOADING	13

NOVOBONE

NOVOBONE GRANULES.....	14
------------------------	----

**READ THROUGH THE CLINICAL CASES
AND DISCOVER THE FULL RANGE OF B&B
DENTAL PRODUCTS**

VISIT THE SECTION OF THE WEBSITE AND
FILL OUT THE FORM TO SUBMIT YOUR CASES!



REGENERATION EXPLAINED

Regeneration in dentistry is a practice used to restore volume in both hard and soft tissues to recreate the aesthetic and functional balance of a certain area of the oral cavity.

In implantology, regeneration can facilitate implant placement or is also used to improve aesthetic results as it lends tissues a more natural appearance by creating profiles that are more in line with the physiognomy of the face or oral cavity.

B&B Dental has developed a comprehensive line of materials and tools to improve implant results. B&B Dental's philosophy is always that production starts with the careful selection of raw materials, which are then processed using innovative methods, in order to offer quality products that have passed strict scrutiny by our experts.

B&B Dental aims to become your trusted partner for your successful implant practice.



COLLAGEN T-BARRIER MEMBRANES



Collagen T-Barrier Membrane is a resorbable membrane made from equine-derived collagen used to protect implant sites. It can be easily placed on the site after bone grafting and does not require fixation. The membrane provides a perfect basis for hard and soft tissue healing and creates a favourable environment for bone regeneration, as it allows osteogenic-cell growth in the site and avoids unwanted cell migration. It can also be used as a local haemostat.

T-Barrier Collagen also has the ability to act as a balanced barrier with controlled resorption, so as to avoid any inflammatory reaction in soft tissue.

T-Barrier Collagen is available in a wide range of sizes:

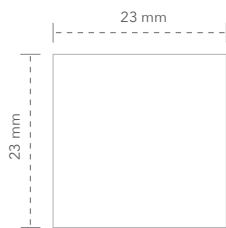

23 x 23 x 0,25 mm**
B-00223*

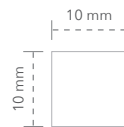

10 x 10 x 0,25 mm**
B-00223/1*

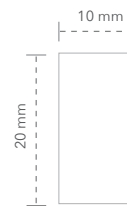

10 x 20 x 0,25 mm**
B-00223/2*

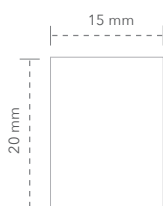

15 x 20 x 0,25 mm**
B-00223/3*

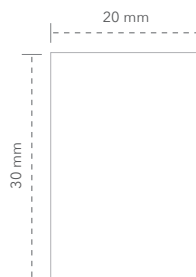

20 x 30 x 0,25 mm**
B-00223/4*

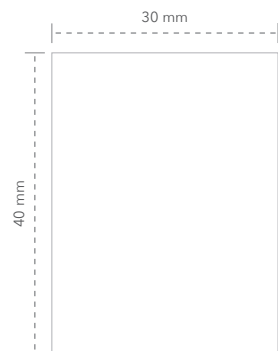

30 x 40 x 0,25 mm**
B-00223/5*

** ± 0.05 mm

* 2 membranes per pack

KEY PROPERTIES COLLAGEN T-BARRIER

Collagen T-barrier Membranes are membranes that can be used both in implant sites and in cases of dehiscence, to protect peri-implant bone defects or to treat small bone dehiscence defects. They may also be used to help repair small tears in the sinus membrane or to cover the access window in maxillary sinus augmentation procedures. They are also used to protect post-extraction cavities, as they improve and speed up healing while maintaining space.

Key properties of the membranes are as follows:

- Equine type I atellocollagen
- Safe and biocompatible
- Easy to apply
- Full resorption within 4 to 6 weeks

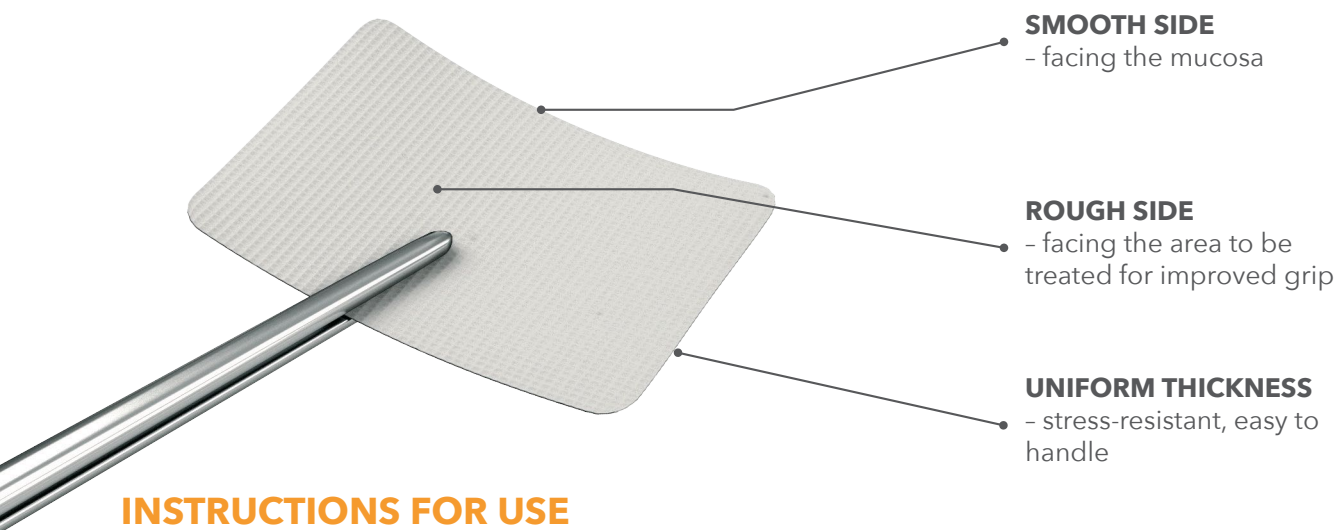

INSTRUCTIONS FOR USE

- The membrane can be cut and moulded into the desired shape.
- Hydrate the membrane in sterile saline solution at room temperature for a few minutes. If the site is bleeding, the membrane can be applied dry.
- Apply the membrane with the rough side facing the area to be treated under asepsis conditions and apply light pressure.
- Cover with the flap.



NOVOCOR

NOVOCOR is an osteoconductive material based on natural madreporite. This material has long been used to repair bone defects especially in the orthopaedic field.

Novocor is made of coral aragonite calcium carbonate (CaCO_3), also known as coral hydroxyapatite, which features a porous, reticulated structure very similar to that of human bone.

Novocor is used as a cavity filler to create a suitable environment that will enhance the biological potential for periodontal bone regeneration.



REF.	DESCRIPTION
00096N	4 capsules - 0.5 g each (Tot. 2 g)

HISTOLOGICAL FINDINGS ON A NOVOCOR PLUS IMPLANT IN HUMAN BONE DURING MAXILLARY SINUS AUGMENTATION SURGERY

"DEPARTMENT OF MAXILLOFACIAL SURGERY AND ODONTOSTOMATOLOGY"
of the UNIVERSITY OF NAPLES "FEDERICO II" (2003)

Sample taken from patient after 8 months:

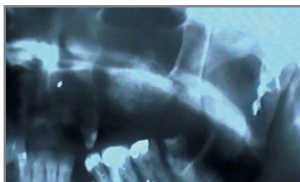

Final X-ray at 8 months.

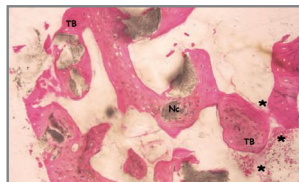

Good osseointegration among Novocor granules and the new bone trabeculae is observed.

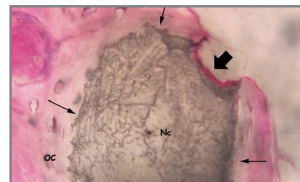

MICRORADIOGRAPH IN HIGHER MAGNIFICATION: Novocor granule (Nc) integrated into the newly formed trabecular bone. The arrows show the locations at which the coral granule was eroded and replaced with highly mineralised bone.

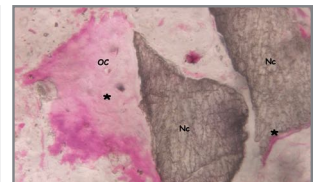

Bone mineralisation around the Novocor granules with no interposed connective tissue is clearly visible.

KEY PROPERTIES NOVOCOR

Novocor can be used to fill bone dehiscence defects, promote and speed up bone stabilisation and the healing and osseointegration process of implants. Uniform grain size and an innovative preparation method make Novocor an ideal osteoconductive material.

Novocor has the following characteristics:

- Ease of preparation, high mouldability
- Long-term dimensional stability
- High biocompatibility
- Full resorption within 6 to 12 months

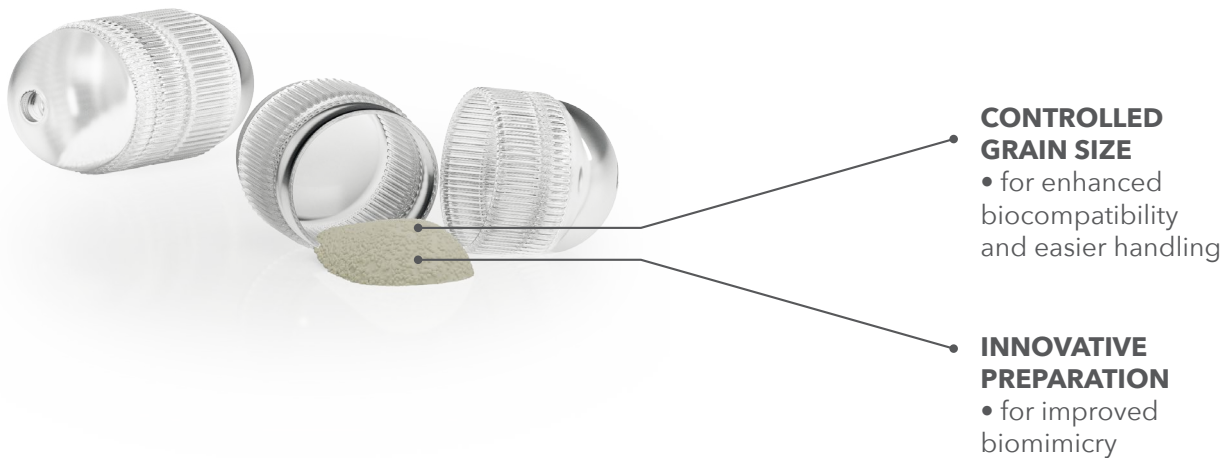

INSTRUCTIONS FOR USE

- Measure the necessary amount of product and place it into a sterile container
- Add sterile saline solution and allow to hydrate for 2 to 3 minutes
- Mix in an amalgam mixer for 30 seconds up to 1 minute depending on how compact you want the final product to be
- Apply the mixture to the area.

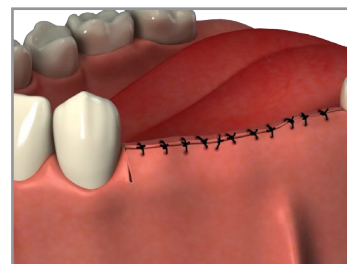
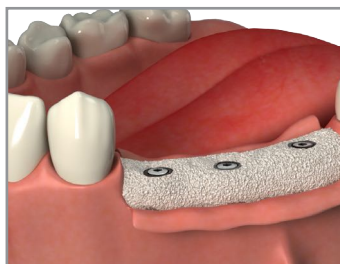
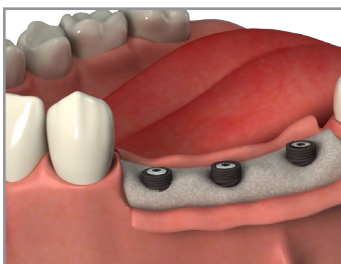

TITANIUM T-BARRIER MEMBRANES

Titanium T-Barrier membranes are titanium grids that are fixed to the implant with a fixation screw to prevent it from shifting within the sinus. Or they are fixed to the bone with osteosynthesis screws to keep the regeneration materials in place in the site. These grids are easy to mould into a shape that will fit the crestal bone.

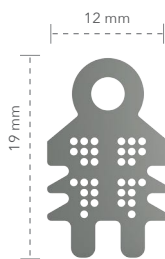
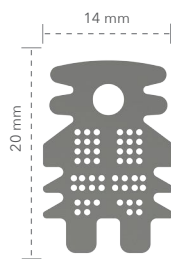
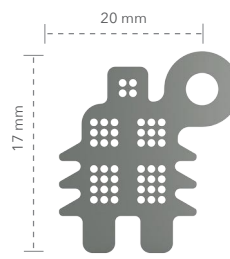
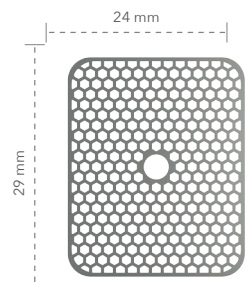
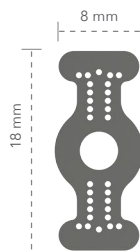
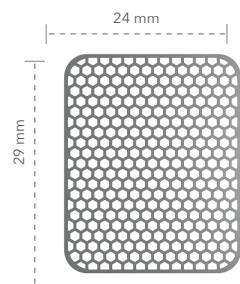
00532/3⁺00532/4⁺00532/5⁺00532/12⁺00532/10⁺00532/1⁺00532/2⁺00532⁺

*1 pc per pack
thickness 0.13 mm



* Fixation screw 00532SCREW
included

OSTEOSYNTHESIS SCREWS

Osteosynthesis screws have a very sharp thread to facilitate insertion. Their cross head helps the screw stay engaged with the suitable screwdriver.

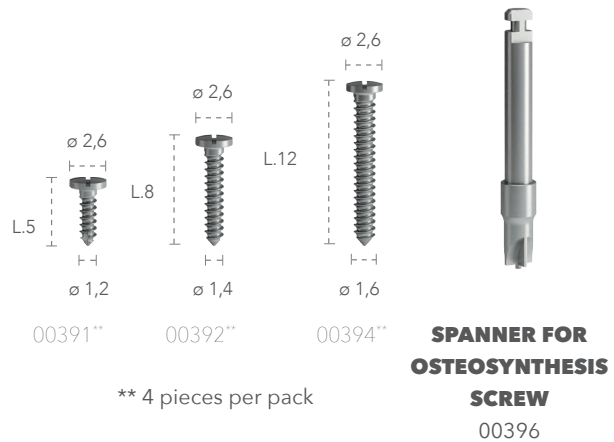

Osteosynthesis screws can be used to fix all (titanium and collagen) T-barrier membranes. Membranes can be used for both the upper and lower dental arches of patients with bone defects that would otherwise prevent implant treatment or pose serious constraints. The membranes are easy to cut and come in sterile packs ready for immediate use.

INSTRUCTIONS FOR USE

- Open the pack and remove the membrane
- Bend and mould the membrane so as to fit the area to be treated
- Insert the osteosynthesis screws or the fixation screw to secure the membrane in place.

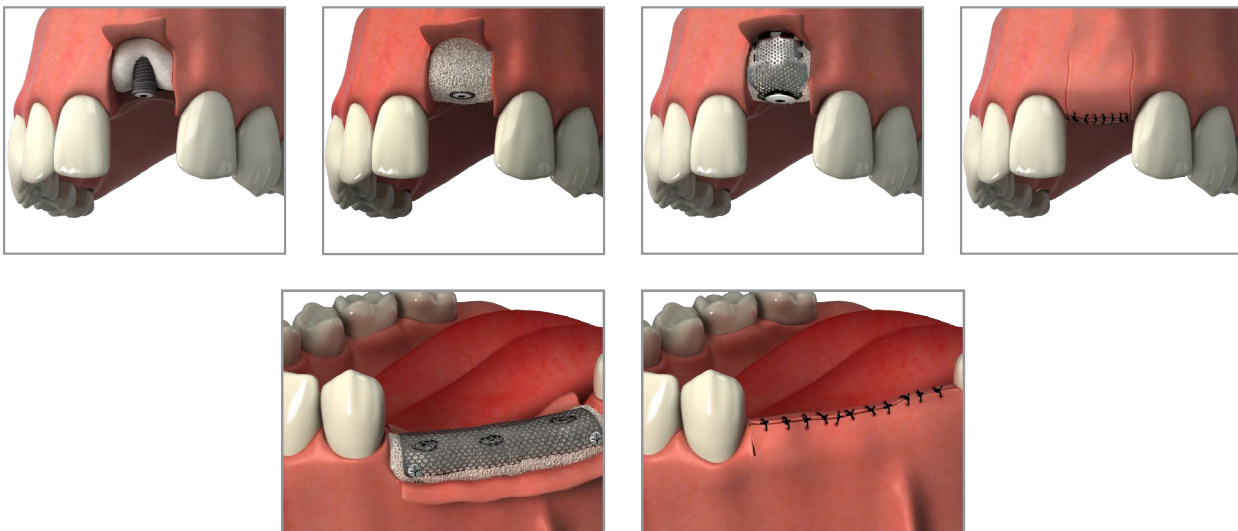

CLINICAL CASES

AESTHETIC-FUNCTIONAL RESTORATION IN FRONTAL POST-EXTRACTION SITE

ALESSANDRO CECCHERINI

The treatment plan for this patient consists in the placement of an EV implant in the anterior area. Because the site is in a position of high aesthetic significance, volumes need to be preserved for an optimal aesthetic result.

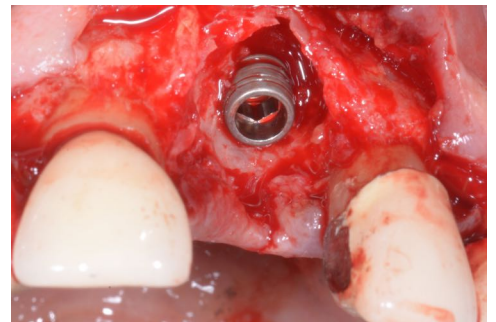

Extraction of compromised central incisor, cleaning of the cavity and insertion of an implant from the EV line - self-tapping thread, underprepared osteotomy - in post-extraction phase for improved bone volume maintenance.



Because the implant was free of the vestibular lamellae, we opted for inserting bone regeneration material and cover the site with a collagen T-barrier membrane for enhanced healing and tissue maintenance.



Healing at 3 months. During this session, the flap was reopened to insert the healing screw and remodel the transmucosal contour.

IMPLANT WITH COMPLETE ABSENCE OF VESTIBULAR LAMELLAE FOLLOW-UP AT 7 YEARS

LUTFI UJAM

Upon presentation, the patient had had an incisor extracted a few months earlier and wished the aesthetics of their smile restored, preferably with a fixed restoration. Upon initial assessment, bone tissue exhibited a vertical bone dehiscence defect.

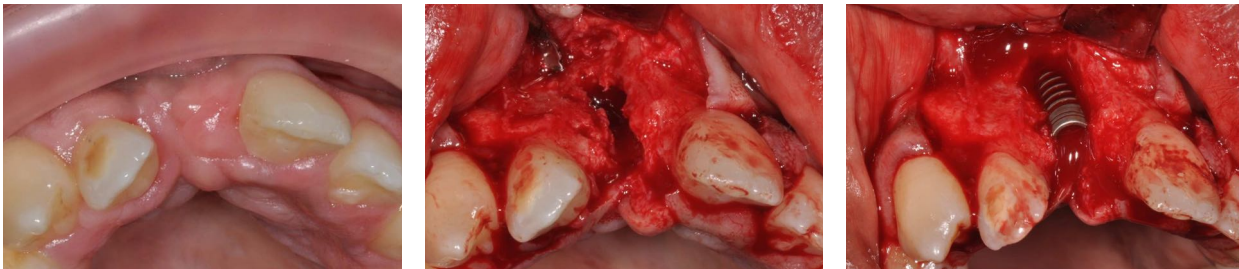

During the preparation of the osteotomy it was impossible to maintain the vestibular lamellae. Since the position has high aesthetic impact, it is necessary to restore frontal bone volume both for the long-term stability of the implant and the aesthetic result of the treatment.

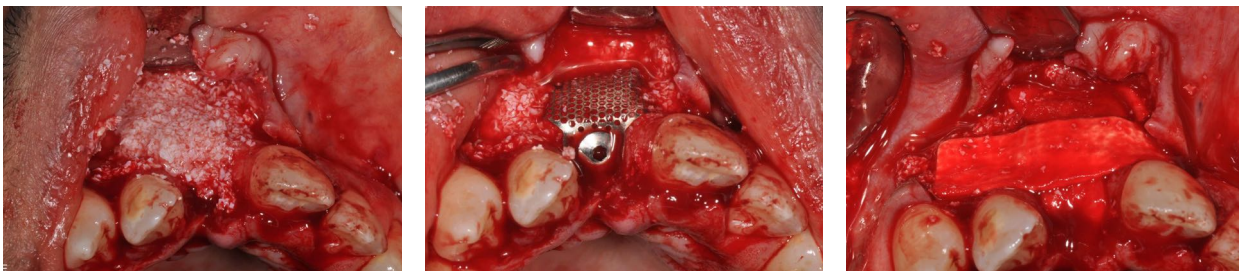

The procedure was carried out with a full-thickness flap with relieving incisions to obtain the broadest possible view. This facilitated the insertion of the bone regeneration material, the collagen membrane and the titanium membrane fixed to the implant.

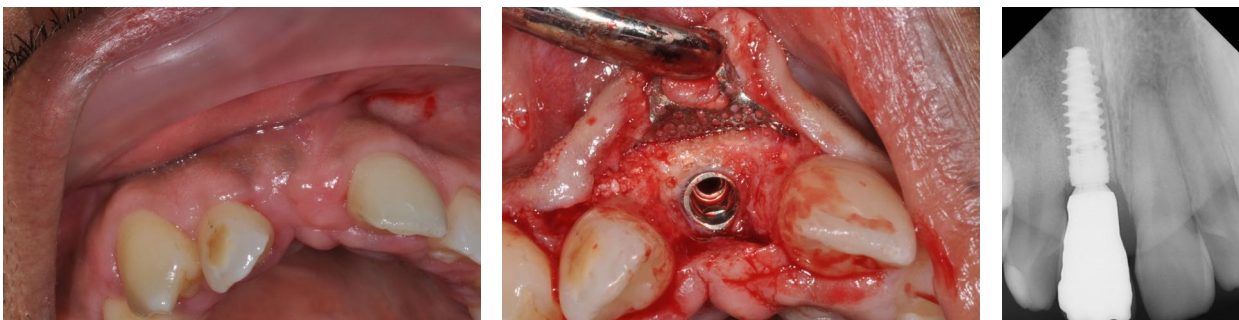

Four months after the first surgical procedure the tissues had healed properly and the flap was opened to remove the titanium membrane. Radiographic check 7 years after surgery: note volume maintenance and proper osseointegration.

VERTICAL BONE VOLUME RESTORATION

IOANA DATCU

Patient with vertical bone defect. The patient exhibits a resorbed saddle area that is not suitable for implant placement and a decision was made to wait for bone regeneration to occur before inserting B&B Dental implants.



Pre-op radiographic examination to assess the situation: apparent vertical bone defect with thin gingival morphotype. Full-thickness flap with relieving incisions and full detachment from the entire ridge.



Modelling and fitment of titanium T-barrier to suit ridge anatomy, grid is filled with bone regeneration material and fixed with 4 osteosynthesis screws. Dry collagen T-barrier membrane is added with rough side facing the mucosa for better adhesion.



Flap is reopened at 4 months and titanium T-barrier is removed. Soft tissue is keratinised and bone volume restored, and now support implant placement. Insertion of 3P and EV implants to suit bone density.

TISSUE MAINTENANCE IN POST-EXTRACTION SITE FOR DELAYED LOADING

FABIO MANUEL FILANNINO

In the event of multiple extractions, besides inserting implants at the same time, optimal site preparation and the use of osteoconductive materials can help maintain and improve proper contours and volumes.



Initial situation: compromised elements that need to be extracted. Horizontal resorption is observed at the location of a previously extracted element. A decision was made to prepare the site with compactors to promote a slight expansion of the ridge.

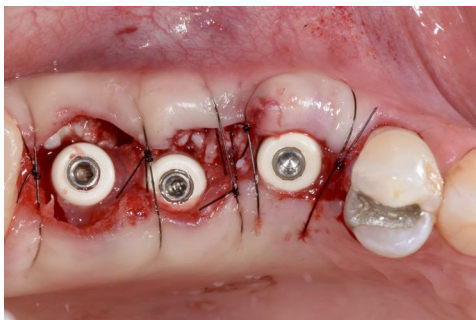
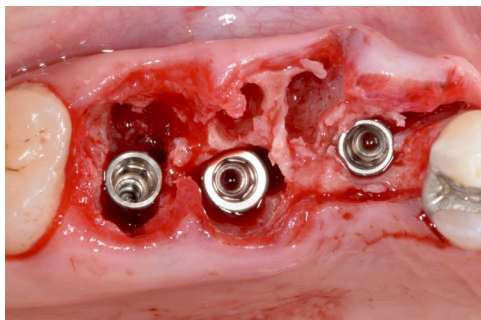

EV plants in position: making use of the post-extraction site, these implants perform at best with their self-tapping ability for guaranteed good primary stability. Bone regeneration material is used and healing screws are inserted before closing the flaps with minimal traction.

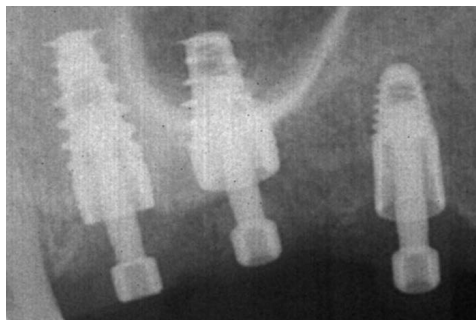

Healing at 4 months: visible contour improvement at element 15, perfect tissue maintenance and preservation of bone dimensions at the other two locations, X-ray check of the area.

NOVOBONE

A full commitment to innovation and a wish to be at your side in every phase of your practice is what led B&B Dental to expand the range to include new materials.

This is why B&B Dental is committed to designing products that meet clinical needs, to improve the way you work and your surgery outcomes.

NOVOBONE GRANULES is a bone regeneration material made of fully deproteinised spongy and cortical bovine bone formulated for complete osteoclastic resorption. The product is in the form of granules that make it easier to measure the necessary quantity.

It will be available in different pre-dosed quantities:



REF.	DESCRIPTION
NBG-0.5	GRANULES, 1 bottle, 0.5 g, grain size: 0.2-0.6mm
NBG-1	GRANULES, 1 bottle, 1 g, grain size: 0.2-0.6mm
NBG-2	GRANULES, 1 bottle, 2 g, grain size: 0.2-0.6mm
NBG-3	GRANULES, 1 bottle, 3 g, grain size: 0.2-0.6mm
NBG-5	GRANULES, 1 bottle, 5 g, grain size: 0.2-0.6mm

THE CERTIFICATION PROCEDURE IS UNDER WAY AND THIS MATERIAL WILL BE ROLLED OUT INTO THE MARKET SOON. WANT TO BE THE FIRST TO KNOW ABOUT IT? FOLLOW US ON OUR SOCIAL CHANNELS!

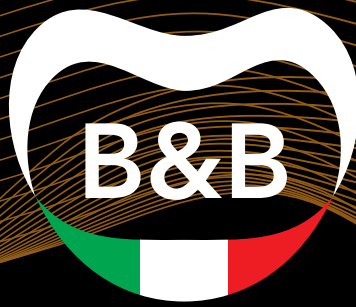

CONTACTS

REGISTERED OFFICE:

Via S. Benedetto, 1837
40018 S. Pietro in Casale (BO) Italy

OPERATIONAL HEADQUARTERS:

Via Due Ponti, 19
40050 Argelato (BO) Italy

Tel. +39 (0) 51.81.13.75

Fax +39 (0) 51.666.94.00

info@bebdental.it

www.bebdental.it



Certified quality system
UNI EN ISO 13485

