



sacred®  
*Symbol of quality*

## DENTAL INSTRUMENTS CATALOGUE

FINE QUALITY DENTAL INSTRUMENTS

OUR VISION YOU ARE IMPORTANT  
OUR MISSION YOUR SATISFACITON

[www.sacred.com.pk](http://www.sacred.com.pk)

VOL. II



OUR VISION YOU ARE IMPORTANT  
OUR MISSION YOUR SATISFACTION



We present here with Great pleasure our General Dental Catalogue, which consists on a distinctive variety of Dental Instruments & Products to cover the utmost needs of Dentistry. We have tried to demonstrate all Instrument Categories, which can be necessary for Dental treatments. Thus, you can request other unmentioned categories too with relevant images or other catalogue references.

All portrayed Instruments made from High Grade Japanese, German and French Stainless Steel. Our Promise is to provide you best ever Quality and Proven Workmanship & our continuous support to Customers make Us Prominent, not only as the best Quality providers but also your trust worthy supporters to understand your actual needs.

For Orthodontic OR Tungsten Carbide Instruments, you can request our other relevant Catalogues.





**000-001**  
Plane 3  
20 mm  
Plane 4  
22 mm  
Plane 5  
24 mm

**000-002**  
Magnifying 3  
20 mm  
Magnifying 4  
22 mm  
Magnifying 5  
24 mm



**000-003**  
Plane 3  
20 mm  
Plane 4  
22 mm  
Plane 5  
24 mm

With Cone Socket



**000-004**  
Magnifying 3  
20 mm  
Magnifying 4  
22 mm  
Magnifying 5  
24 mm



**000-017**  
Front Surface  
Plane 3  
20 mm  
Plane 4  
22 mm  
Plane 5  
24 mm



**000-018**  
Front Surface  
Plane 3  
20 mm  
Plane 4  
22 mm  
Plane 5  
24 mm

With Cone Socket



**000-005**



**000-006**  
Hollow



**000-007**



**000-008**  
Hollow



**000-016**  
Aluminum



**000-020**



**000-019**  
Hollow









**Note:**

If you have preference different from the standard handle shown, please specify the optional handle number when ordering. If the tip/handle combination you desire is not shown, we will be glade to provide you with a quote for its preparation.







300-015  
for 10 instruments



300-016  
for 5 instruments



300-005  
for 22 instruments



300-003  
for 10 instruments



300-001  
for 5 instruments





250-001  
Fig.23

250-002  
Fig.2

250-012  
Fig.17A

250-014  
Fig.3A

250-003  
Fig.16

250-006  
Fig.12

250-009  
Fig.8

250-004  
Fig.9

250-022  
Williams

000-016  
Aluminum



300-022  
Endo Total



300-023  
Endo Total Mini





025-001  
Fig.23

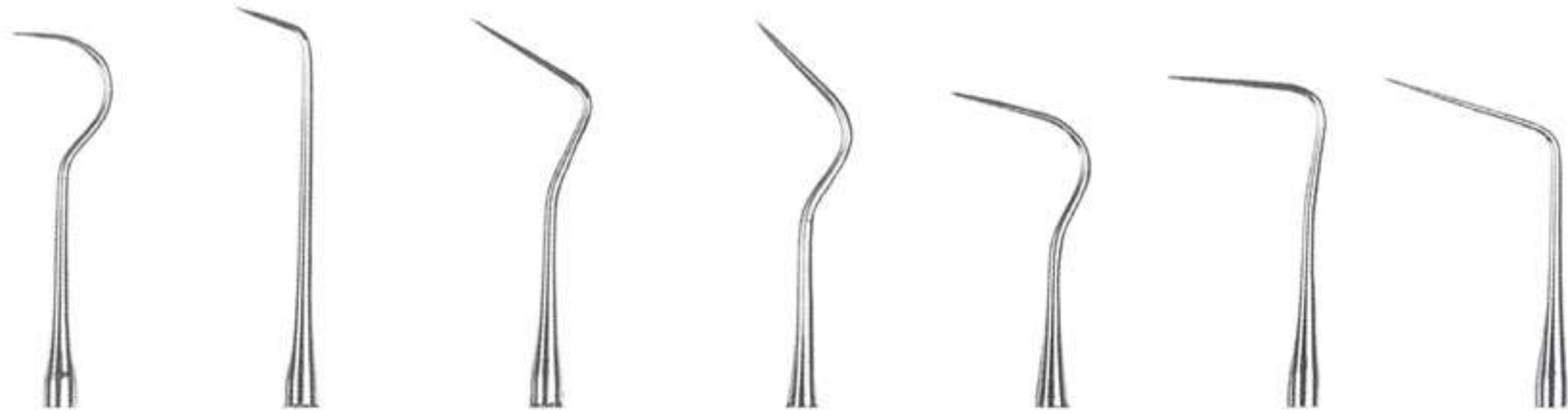

025-002  
Fig.2

025-003  
Fig.16

025-004  
Fig.9

025-005  
Fig.10

025-006  
Fig.12

025-007  
Fig.11

025-008  
Fig.6

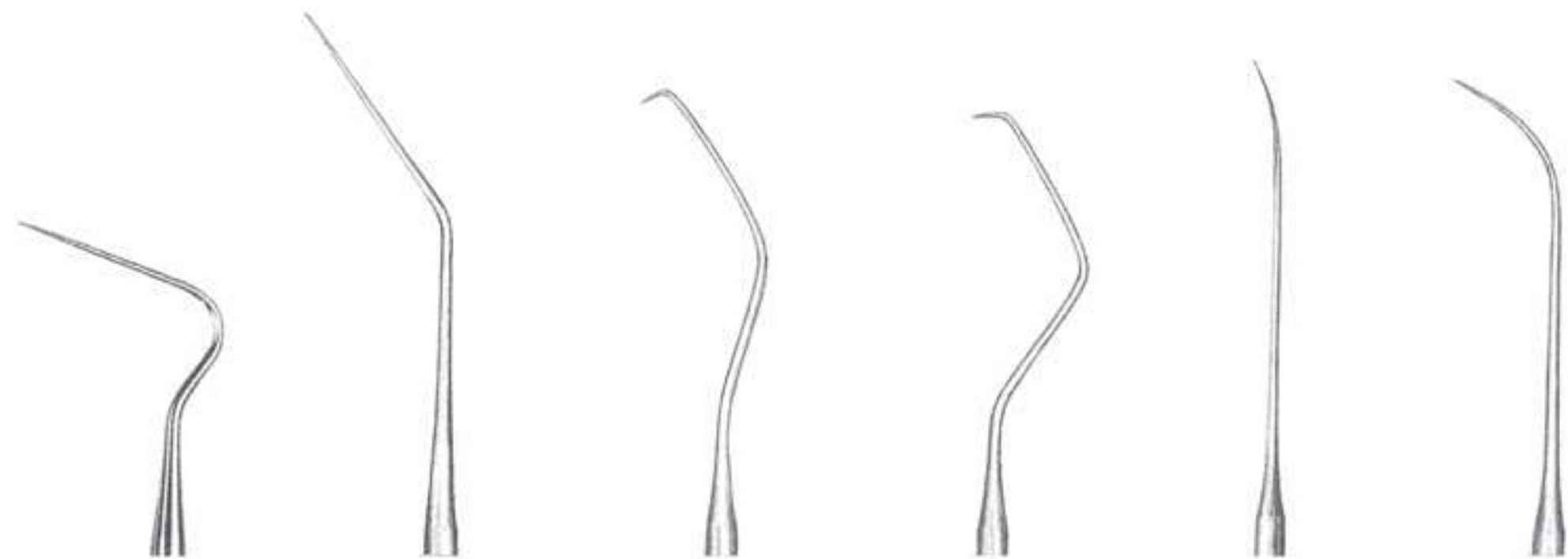

025-009  
Fig.8

025-010  
Fig.5

025-011  
Fig.17

025-012  
Fig.17A

025-013  
Fig.3

025-014  
Fig.3A

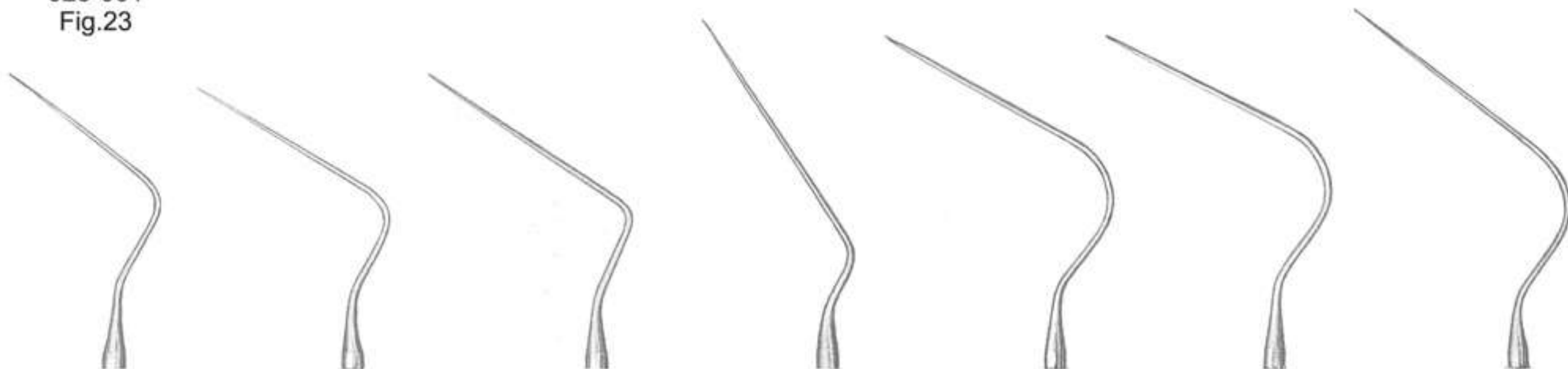

025-015  
Fig.1  
Spreader

025-016  
Fig.2  
Spreader

025-017  
Fig.3  
Spreader

025-018  
Fig.4  
Spreader

025-019  
Fig.5  
Spreader

025-020  
Fig.6  
Spreader

025-021  
Fig.7  
Spreader



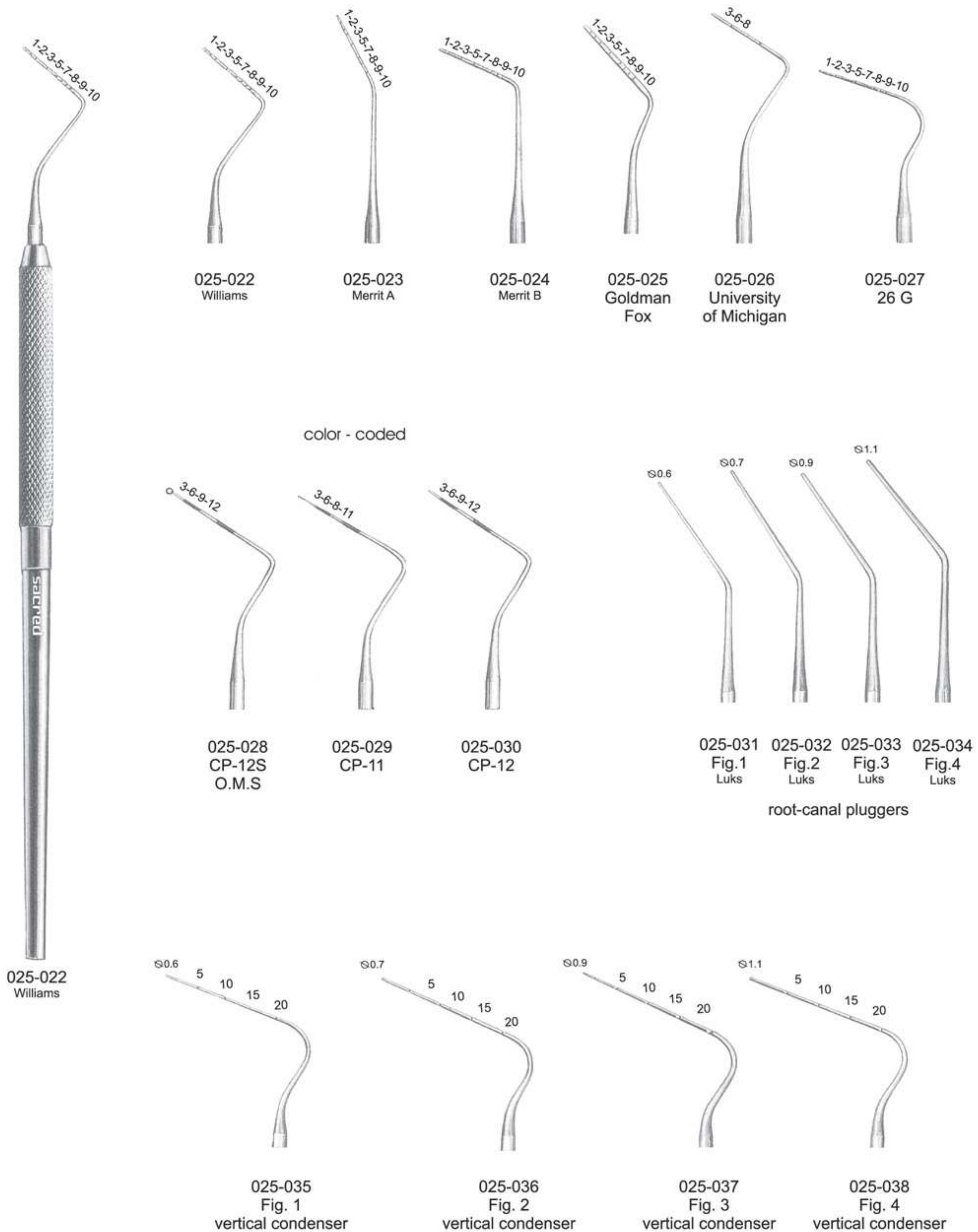



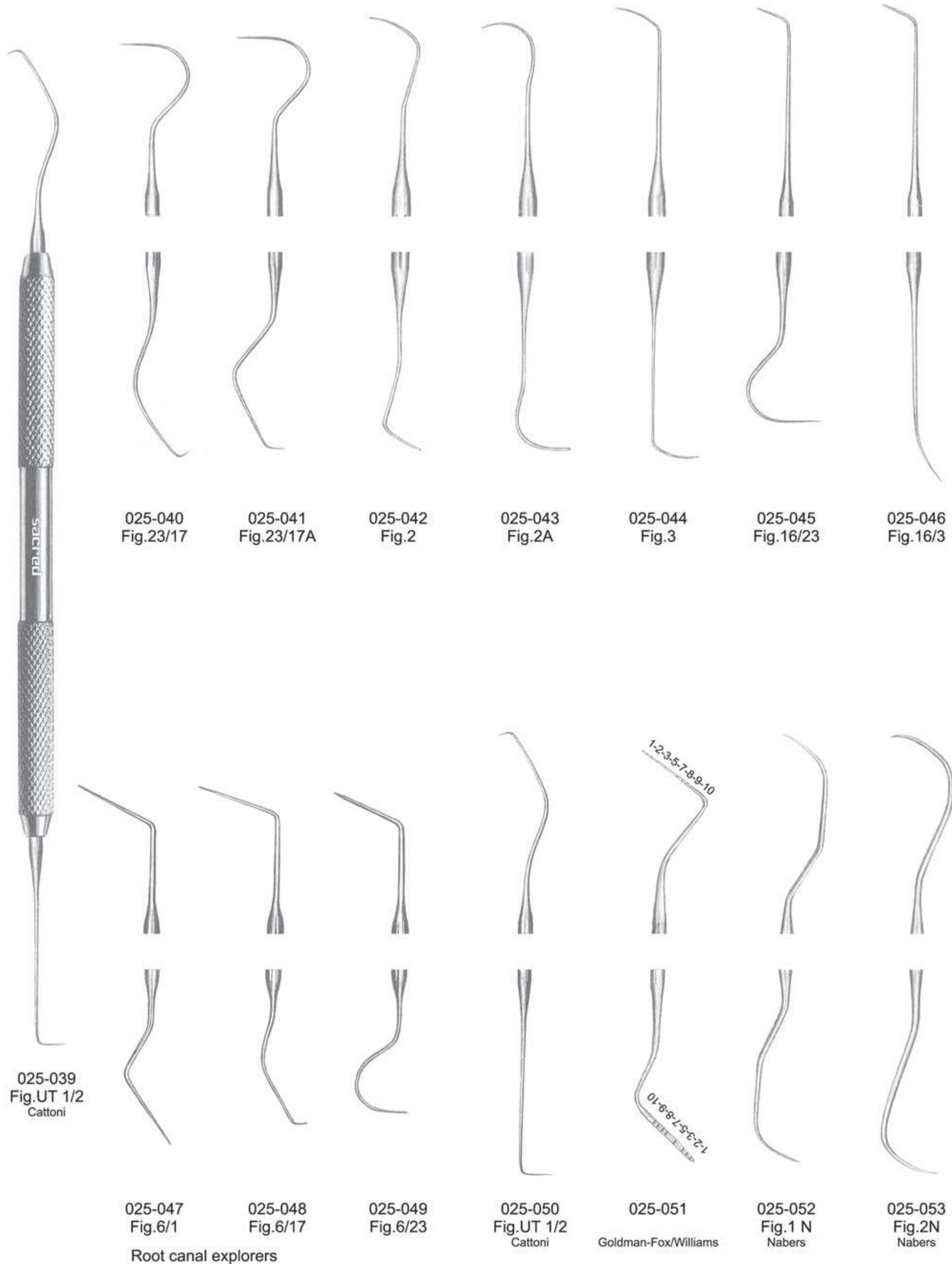



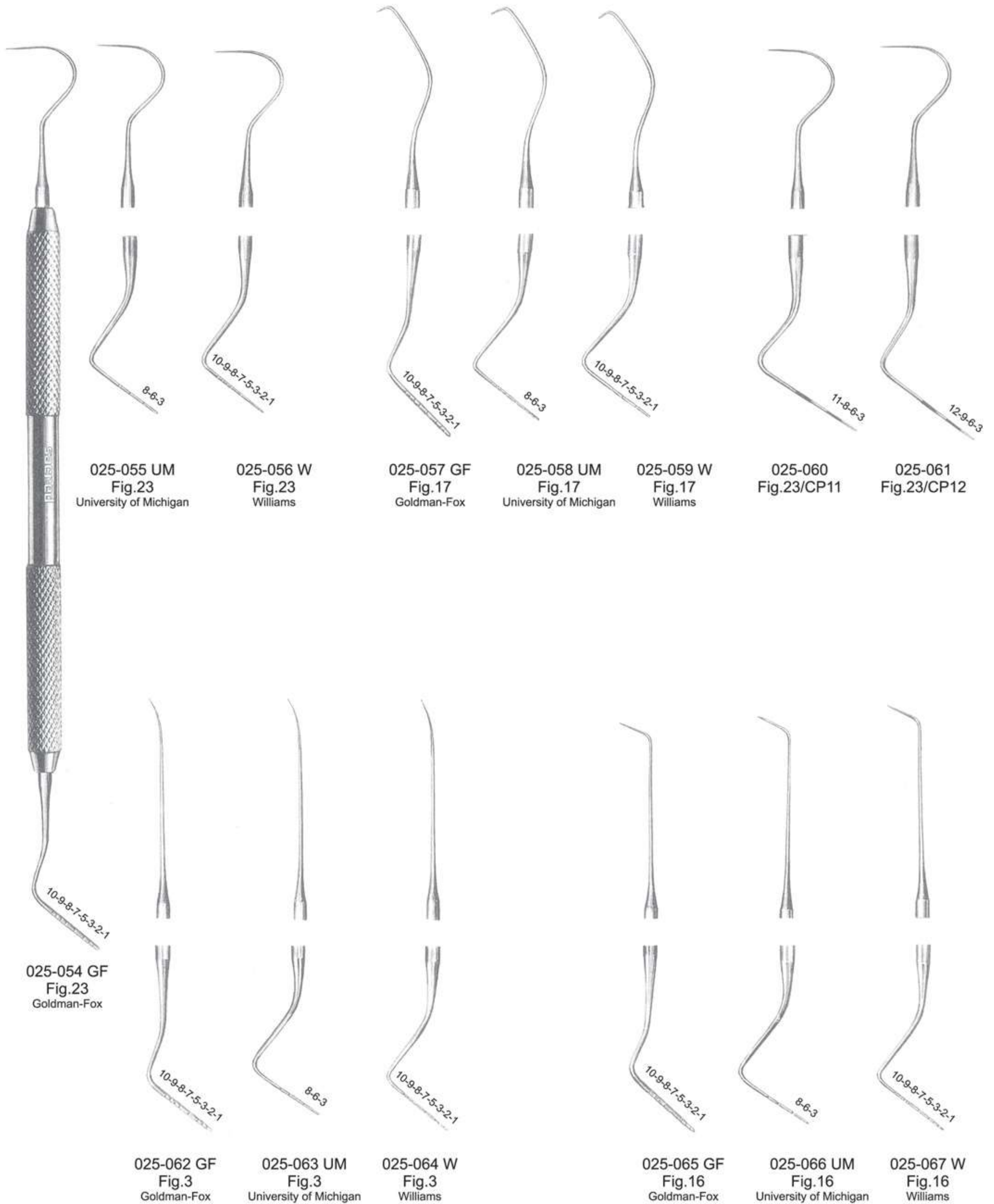



amalgam instruments

serrated

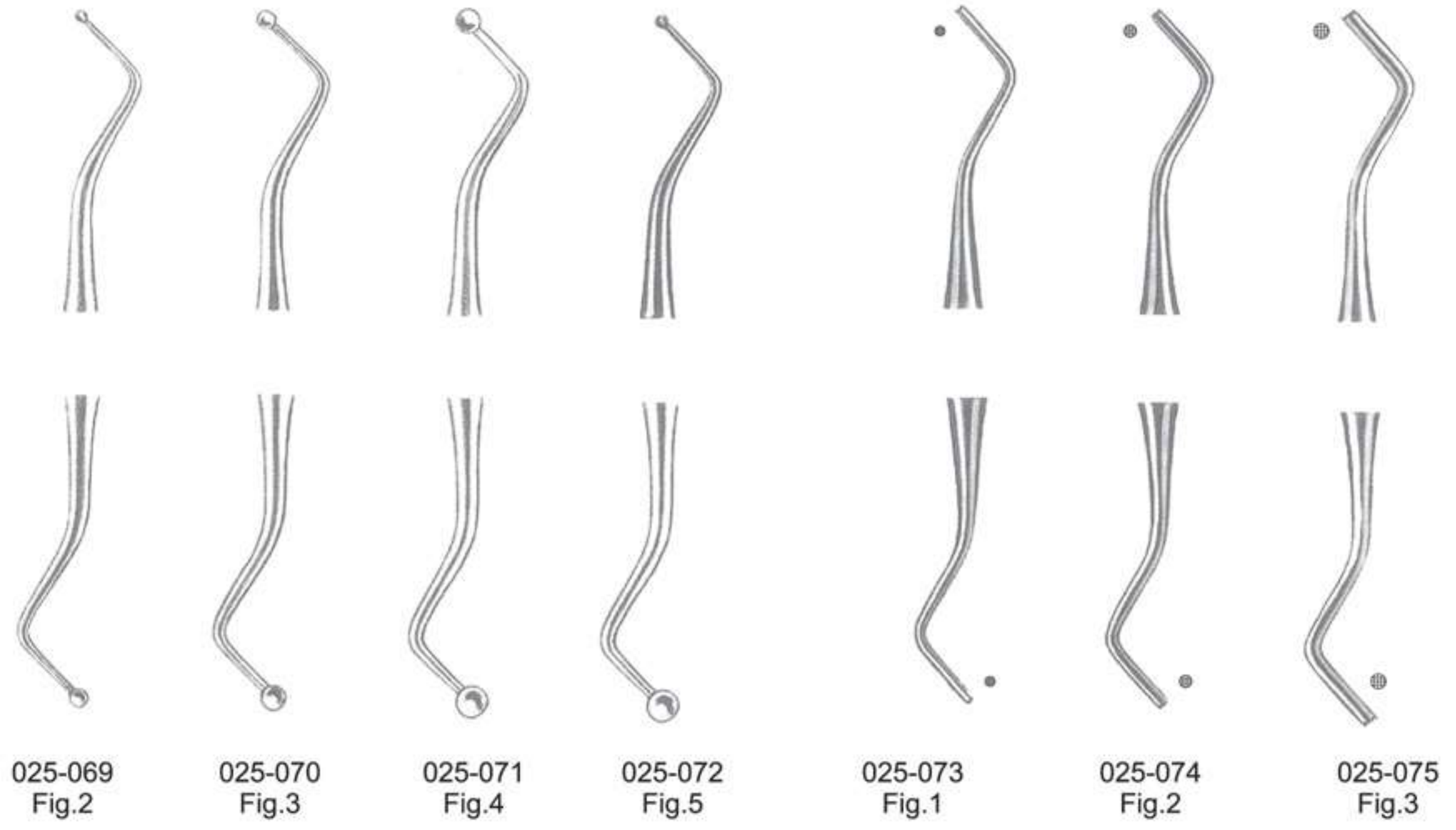

smooth

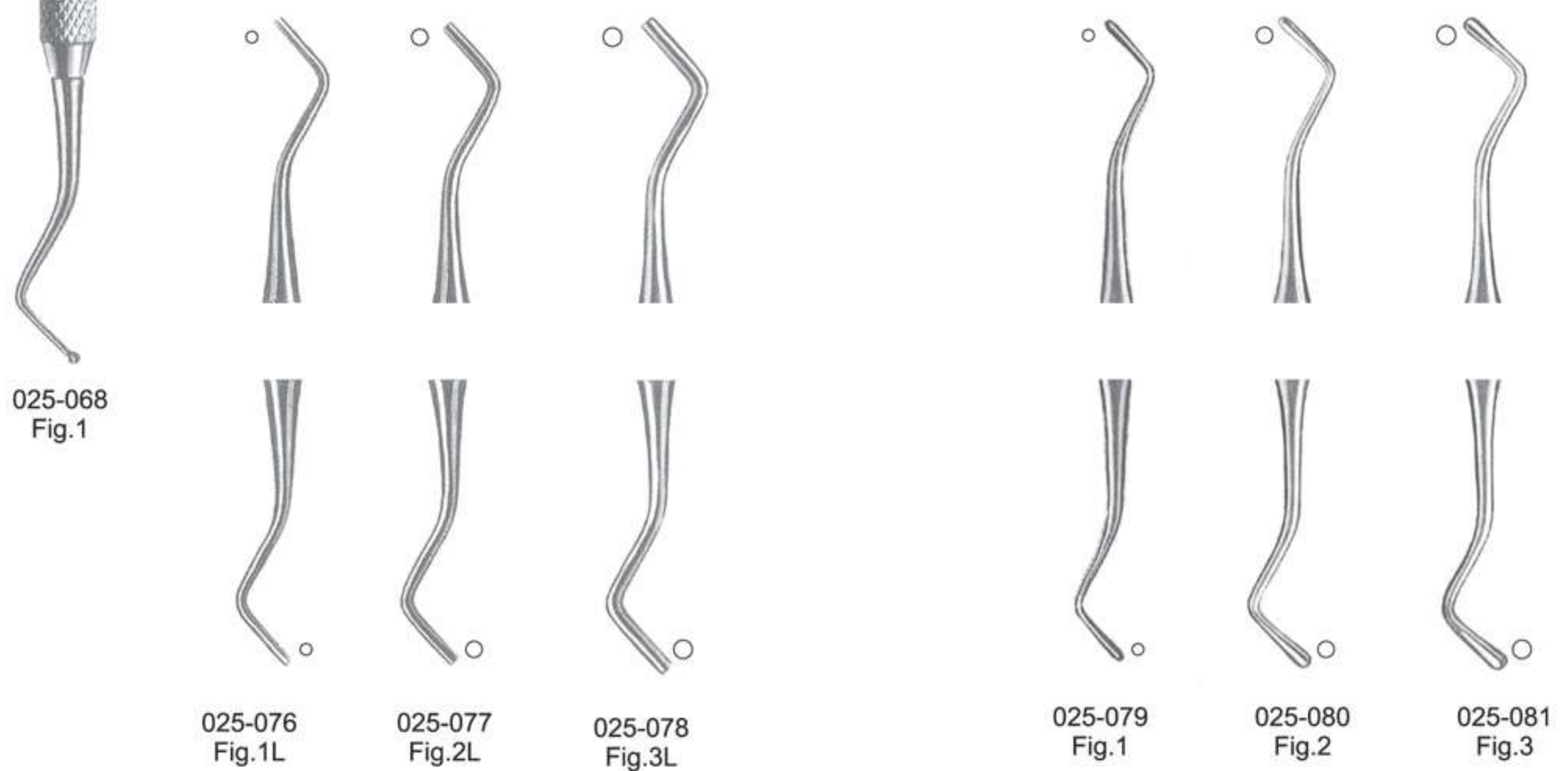



amalgam instruments

serrated

smooth

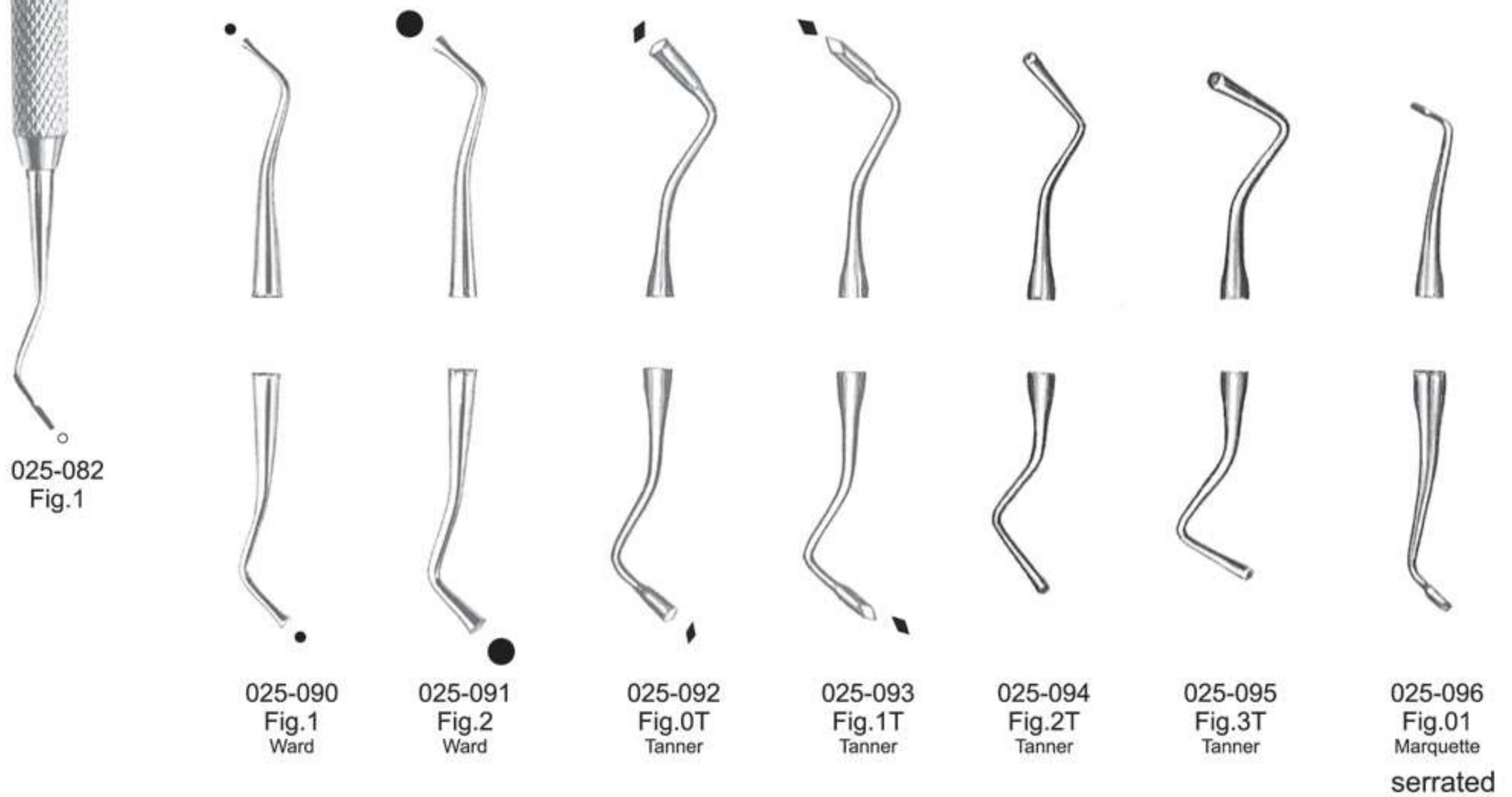
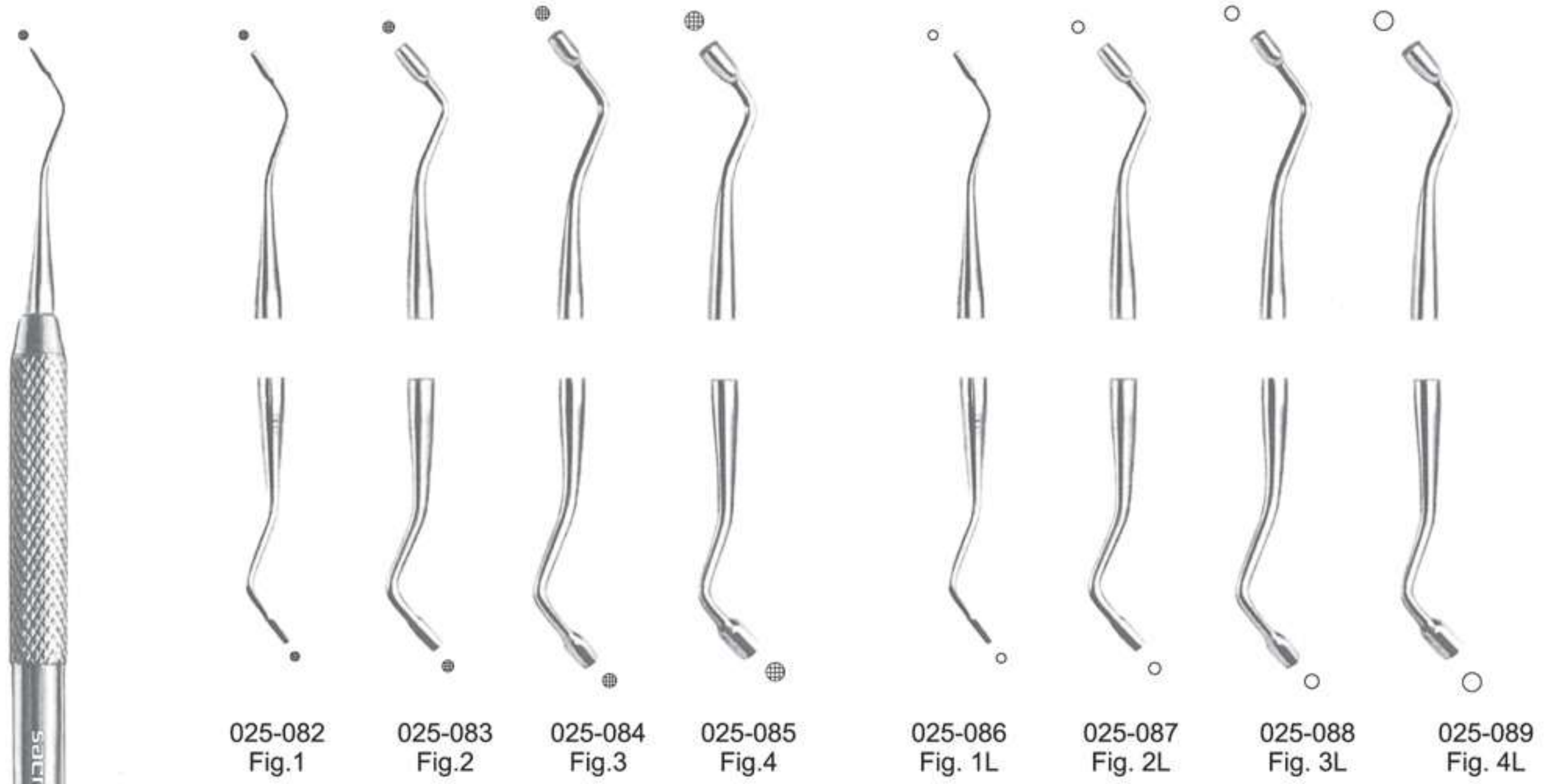



amalgam instruments



025-097  
Fig.1

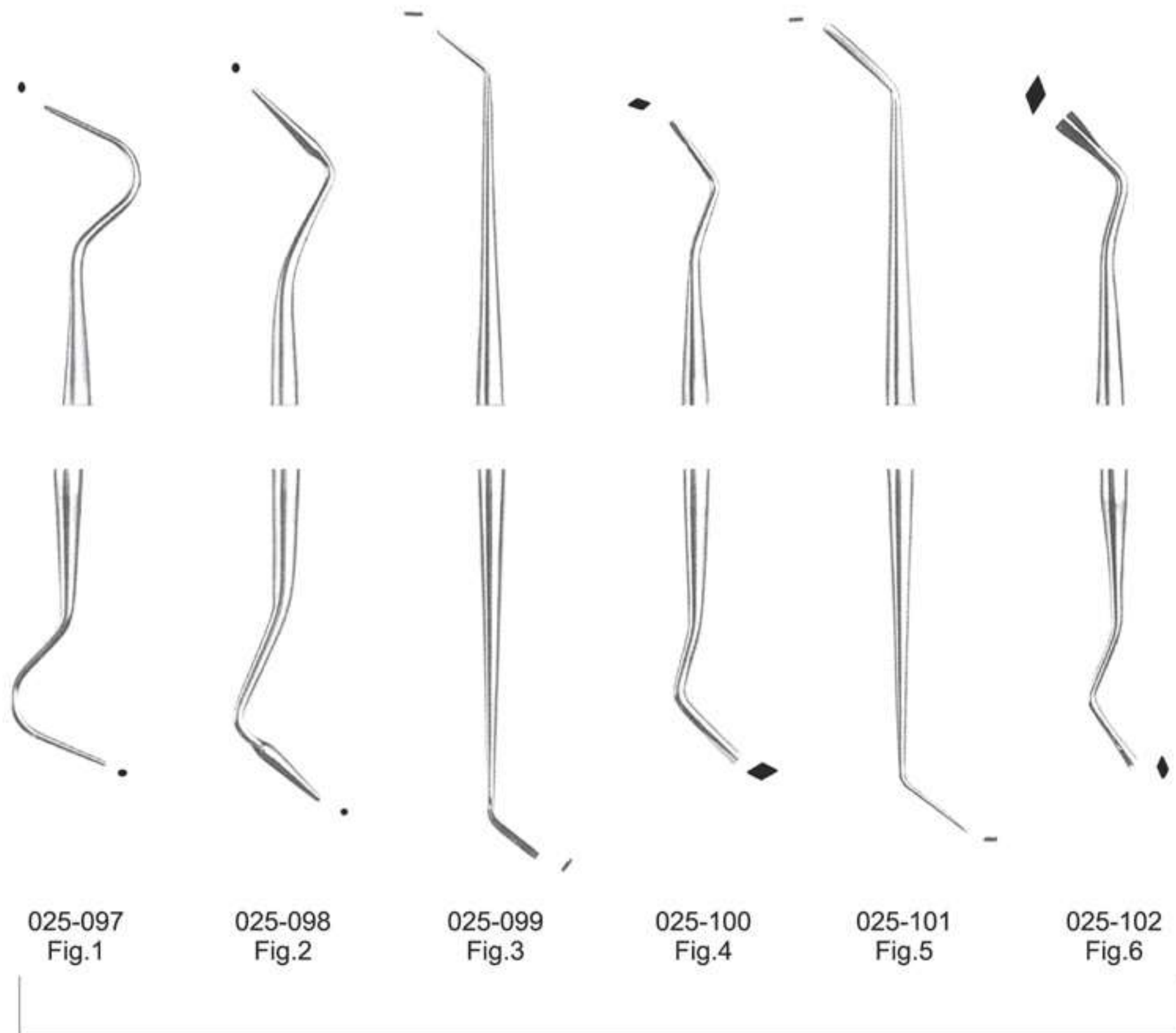

025-097  
Fig.1

025-098  
Fig.2

025-099  
Fig.3

025-100  
Fig.4

025-101  
Fig.5

025-102  
Fig.6

set of 6 pieces

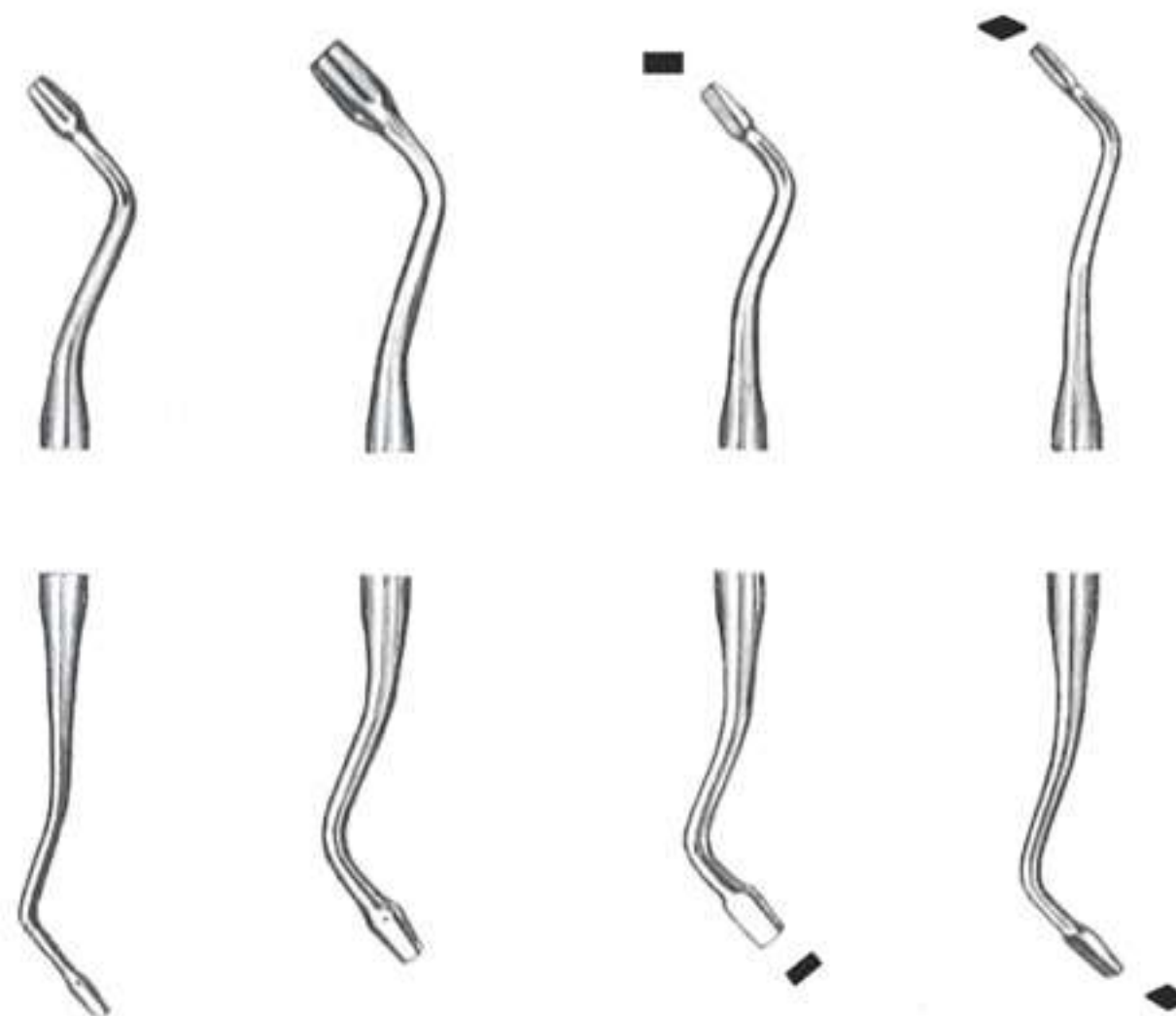

025-103  
Fig. H1  
Hollenback

025-104  
Fig. H2  
Hollenback

025-105  
Fig. H3  
Hollenback

025-106  
Fig. H4  
Hollenback



Burnishers

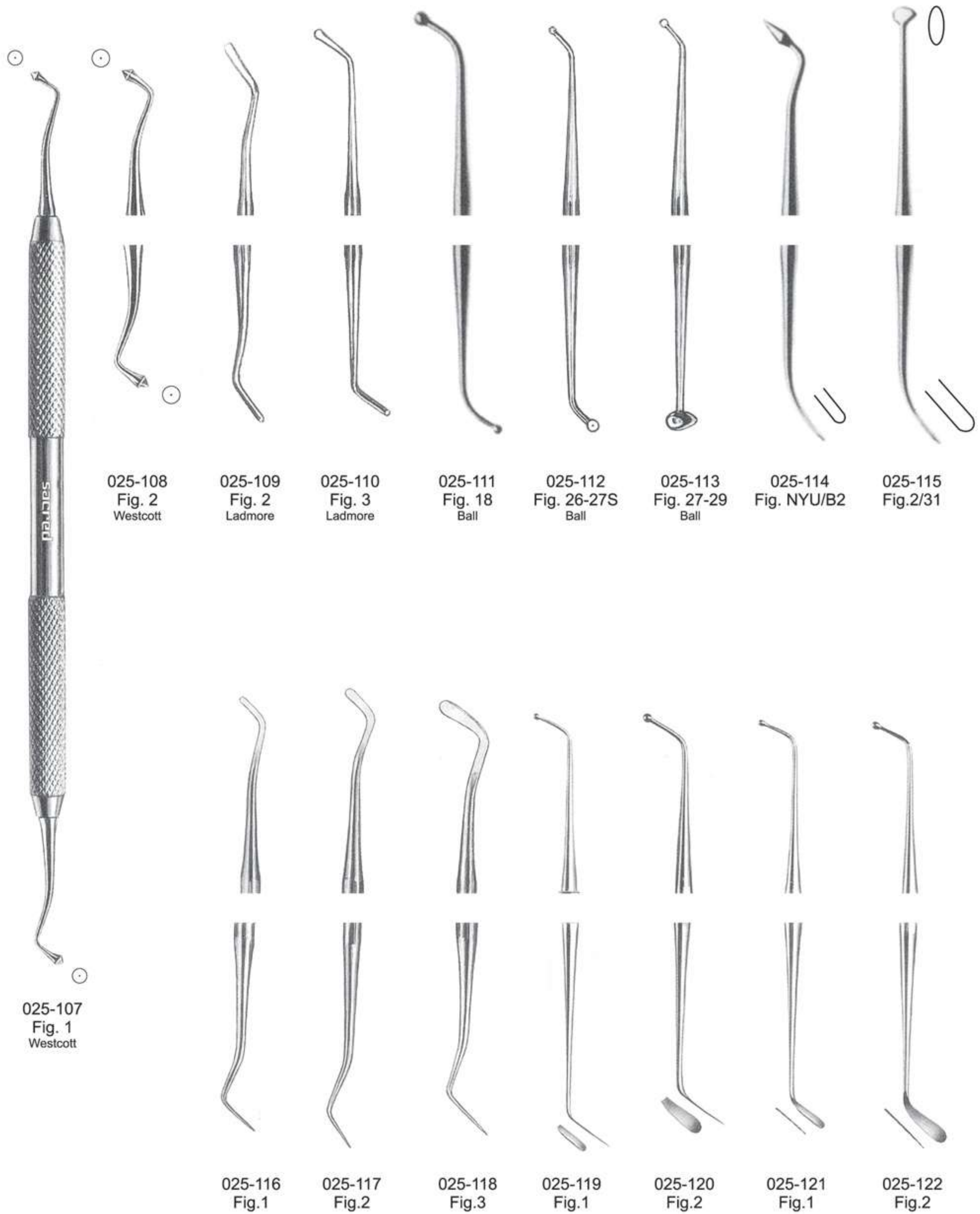

plastic filling instruments



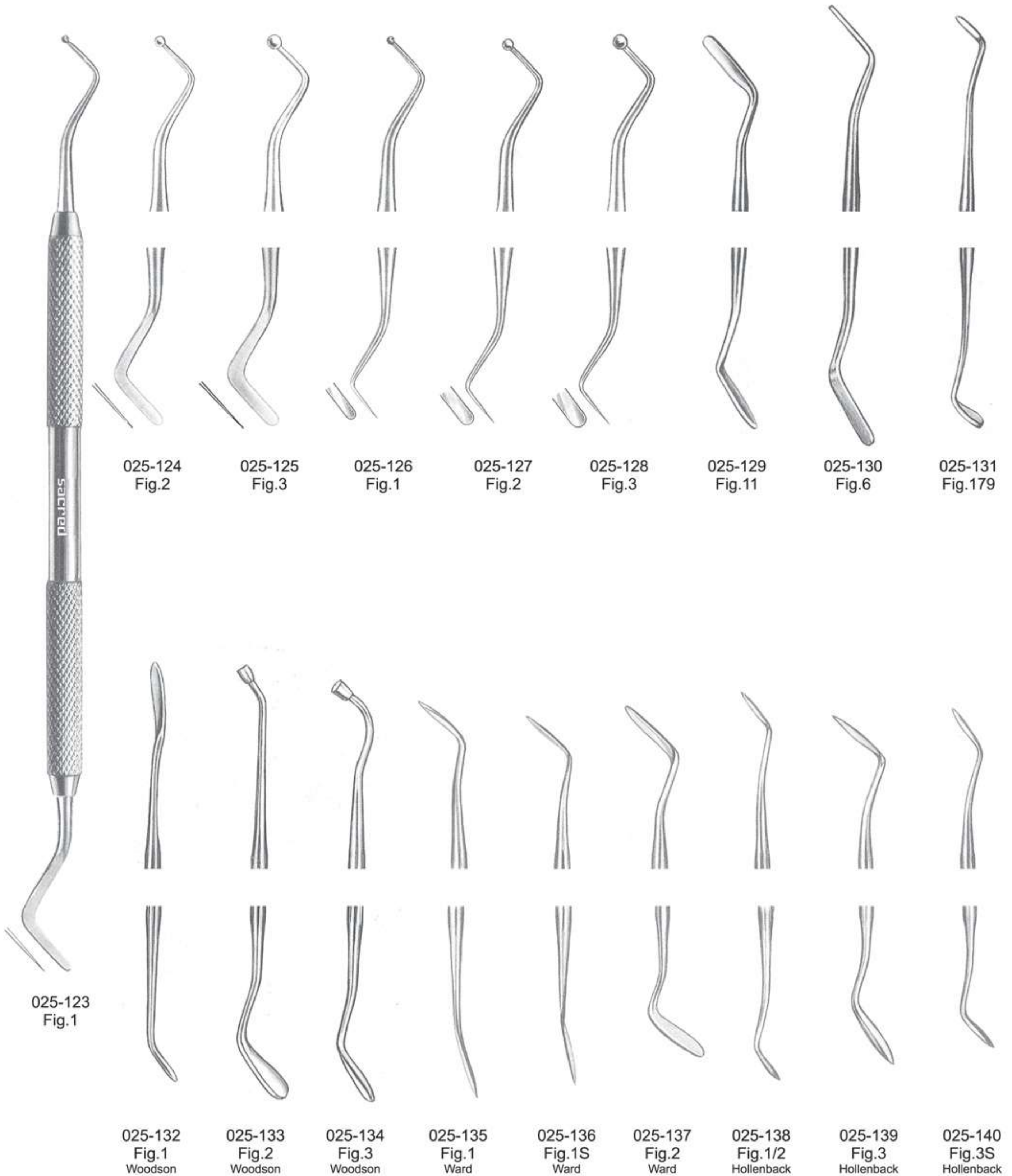



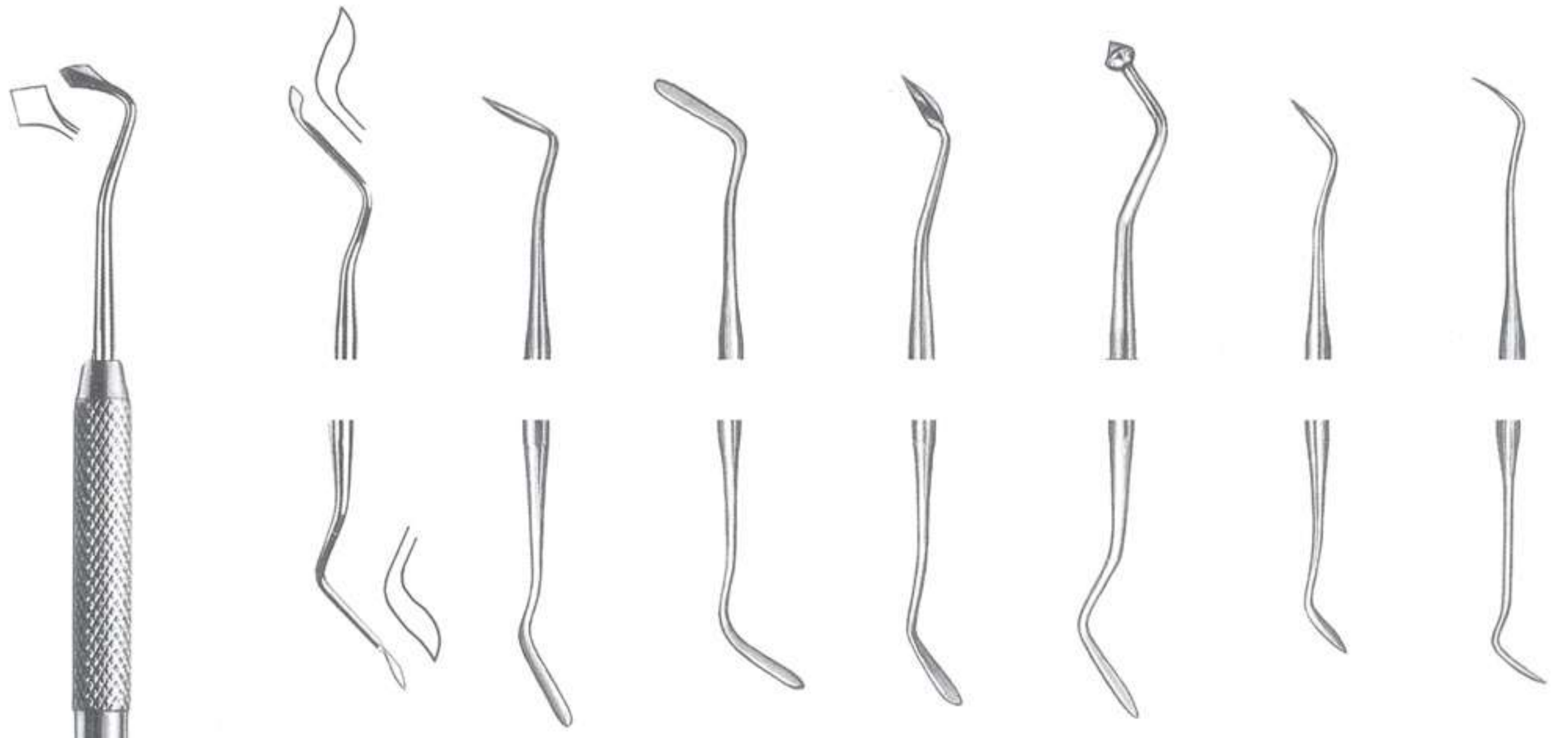

025-142  
Fig.2  
USC

025-143  
Fig.1  
Interproximal

025-144  
Fig.2  
Interproximal  
Off-Angle

025-145  
Fig.SHO-A

025-146  
Fig.3-SHO

025-147  
Fig.104

025-148  
Fig.8  
Wiland



025-141  
Fig.1  
Farhm

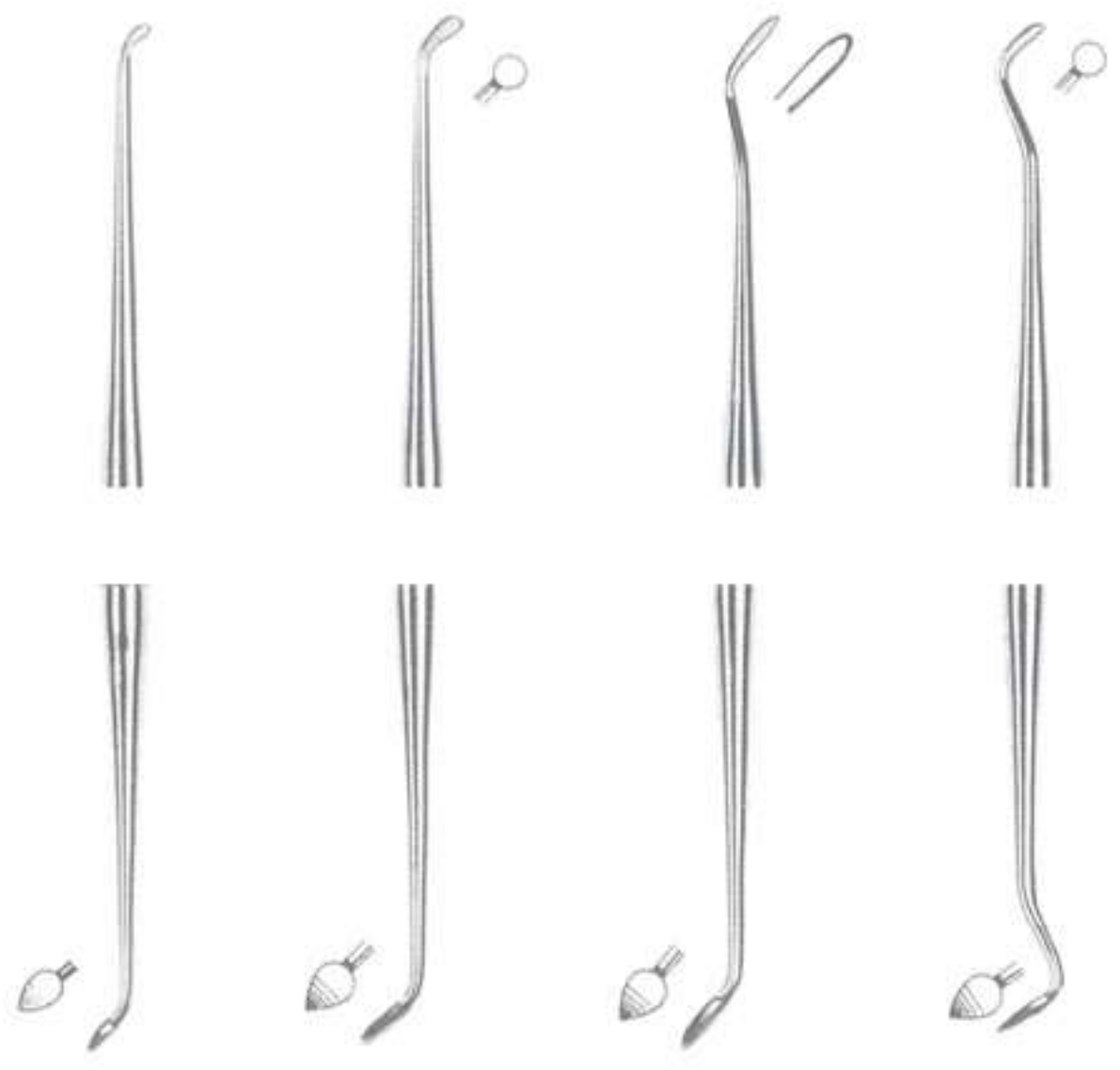

025-149  
Fig.1

025-150  
Fig.2

025-151  
Fig.3

025-152A  
Fig.4

cleoids-discoids

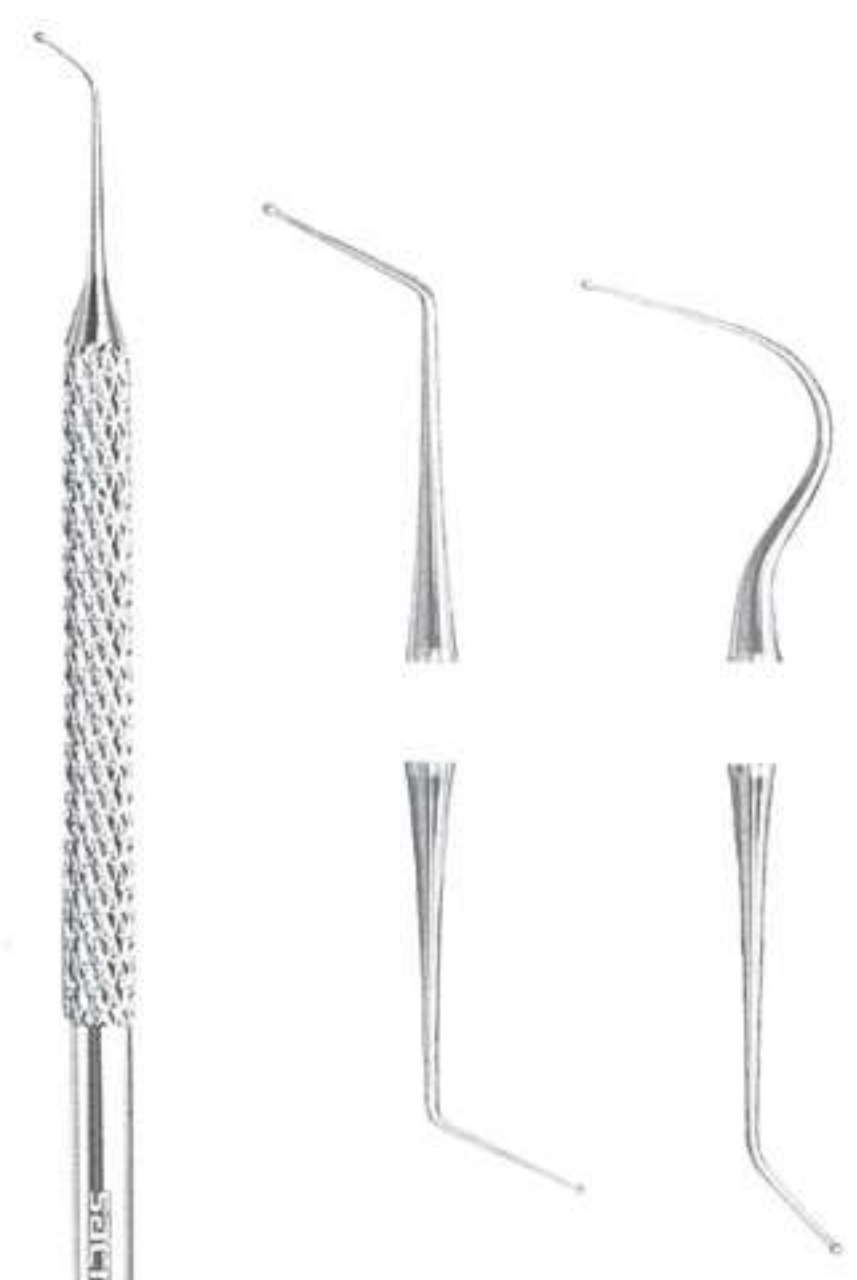

025-152

025-153

025-154

instrument for subgingival application  
of tinctures and medicaments



gingival margin trimmers

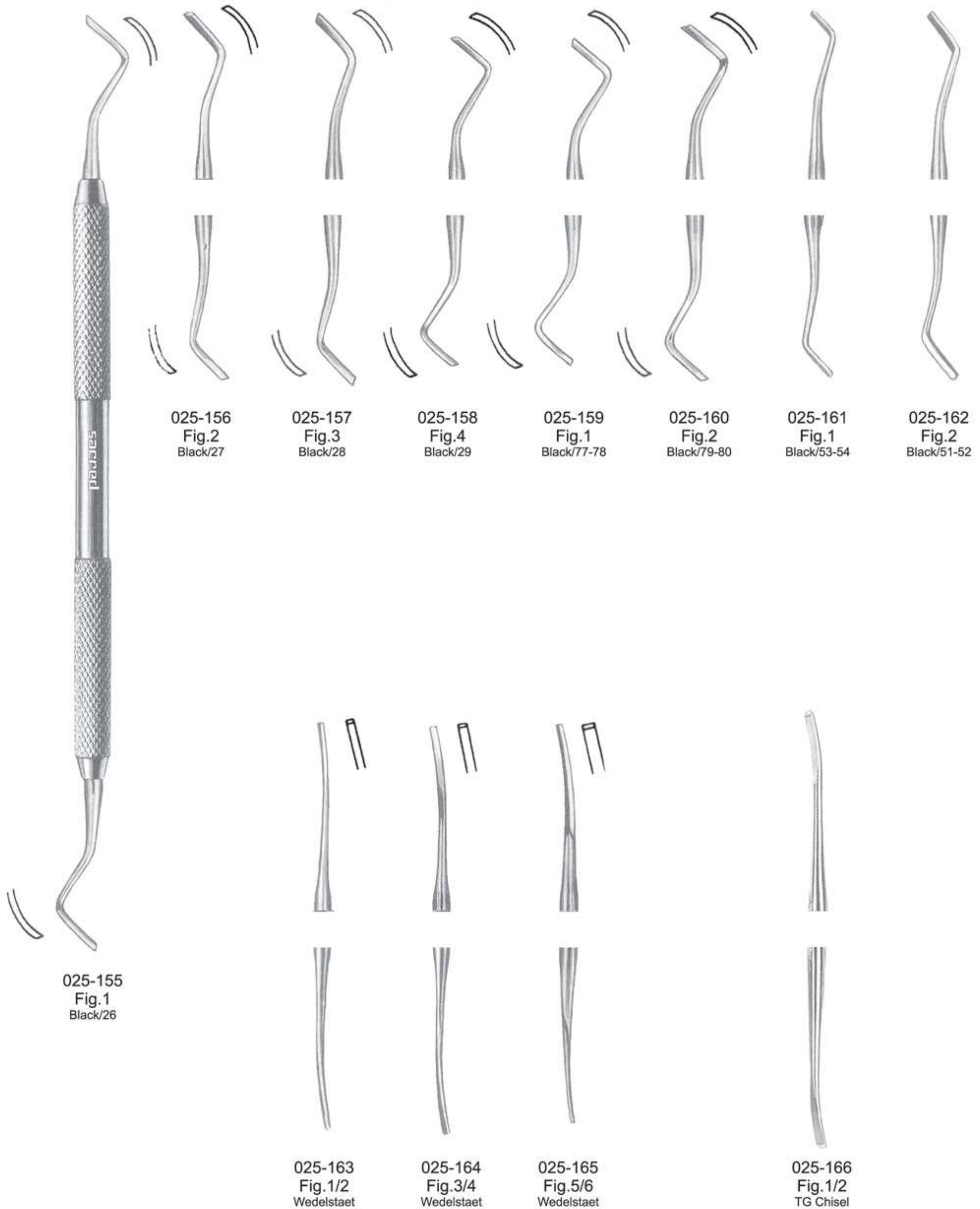



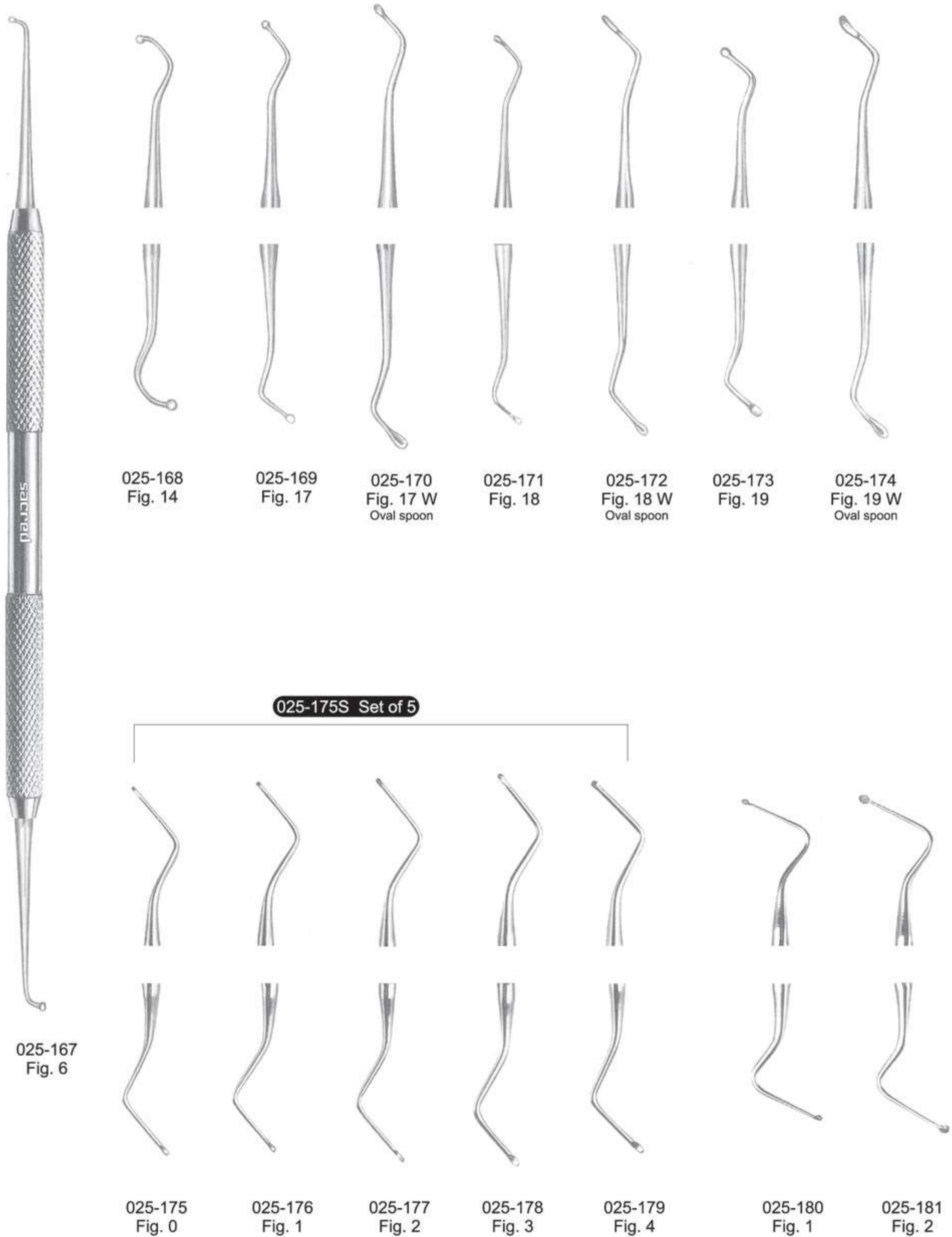



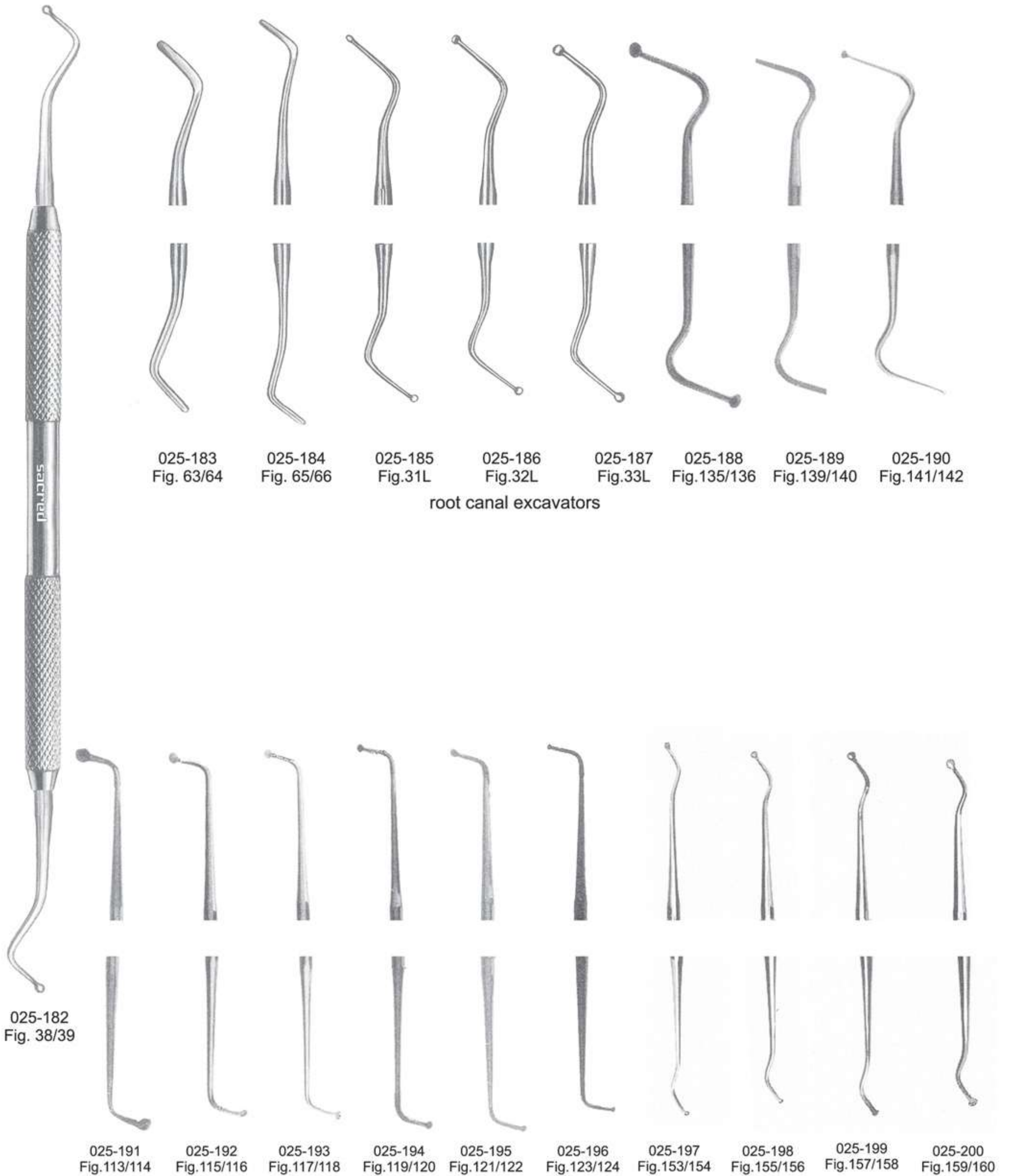



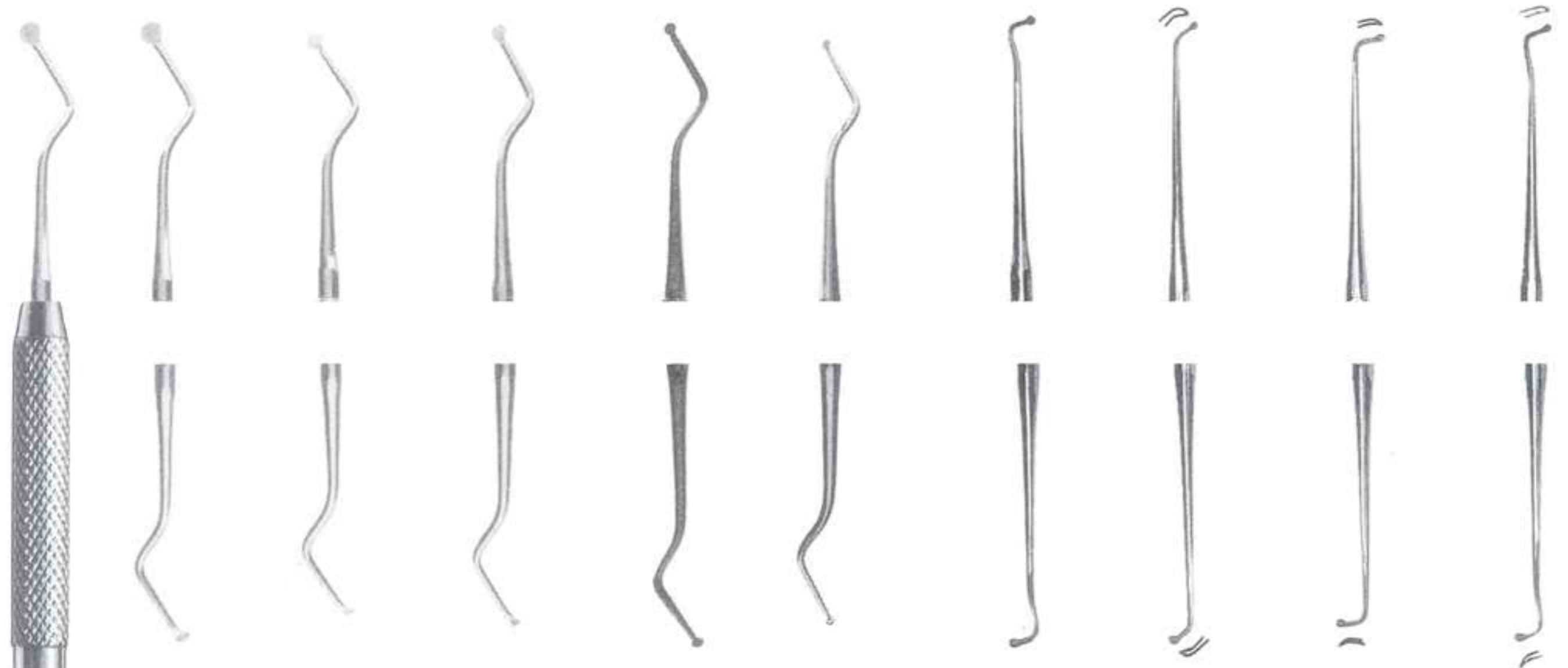

025-201 Fig. 125/126    025-202 Fig. 127/128    025-203 Fig. 129/130    025-204 Fig. 131/132    025-205 Fig. 133/134    025-206 Fig. 9/10    025-207 Fig. 204/205    025-208 Fig. 206/207    025-209 Fig. 208/209



025-201  
Fig. 125/126

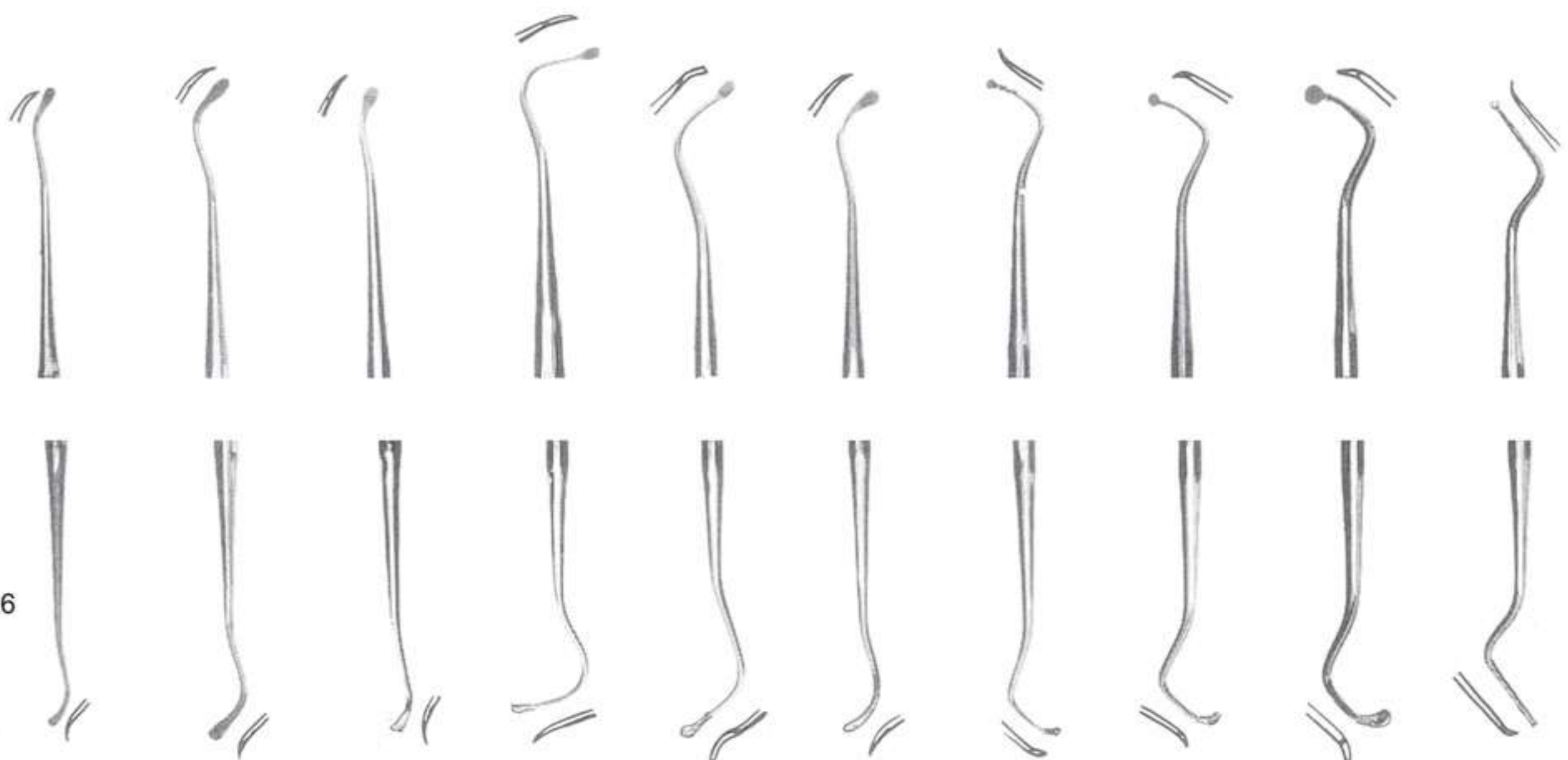

025-210 Fig. 210/211    025-211 Fig. 212/213    025-212 Fig. 214/215    025-213 Fig. 216/217    025-214 Fig. 218/219    025-215 Fig. 220/221    025-216 Fig. 243    025-217 Fig. 244    025-218 Fig. 245    025-219 Fig. 246



025-220  
Fig. M9  
Molt

025-221  
Fig. 1  
Hopkins

025-222  
Fig. 2  
Hopkins

025-223  
Fig. 3  
Mead

025-224  
Fig. PR3  
Prichard

025-225  
Fig. 15  
Freer

025-226  
Fig. 16  
Freer





025-227  
Fig.12 CA

025-228  
Fig.12 A

025-229  
Fig.12  
Howard

025-230  
Fig.33

025-231  
Fig.45  
Miller





025-232  
Fig.1  
Wahl



025-233  
Fig.2  
Wahl

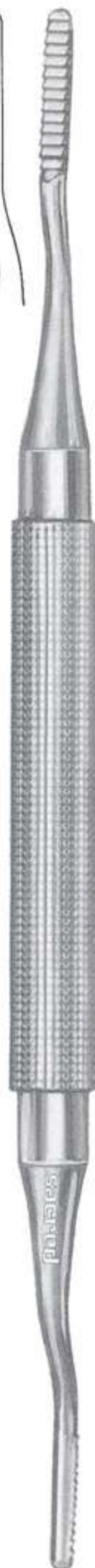
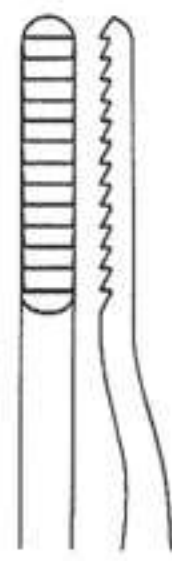

025-234  
Fig.1  
Polokoff

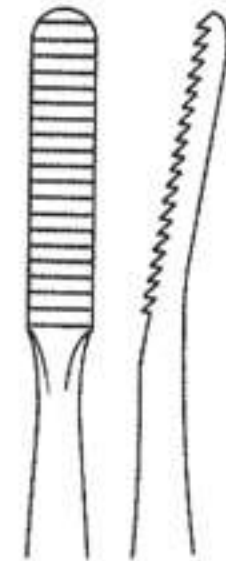

025-235  
Fig.64  
Miller

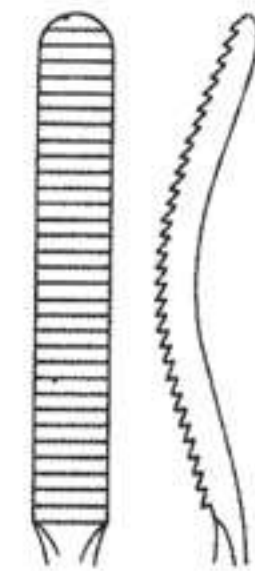

025-236  
Fig.10

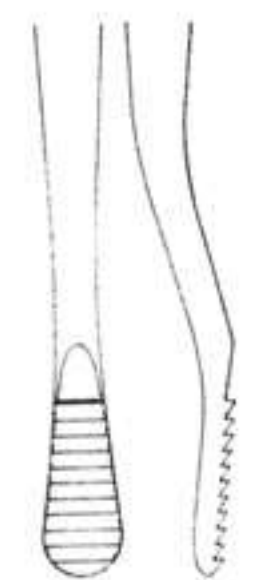



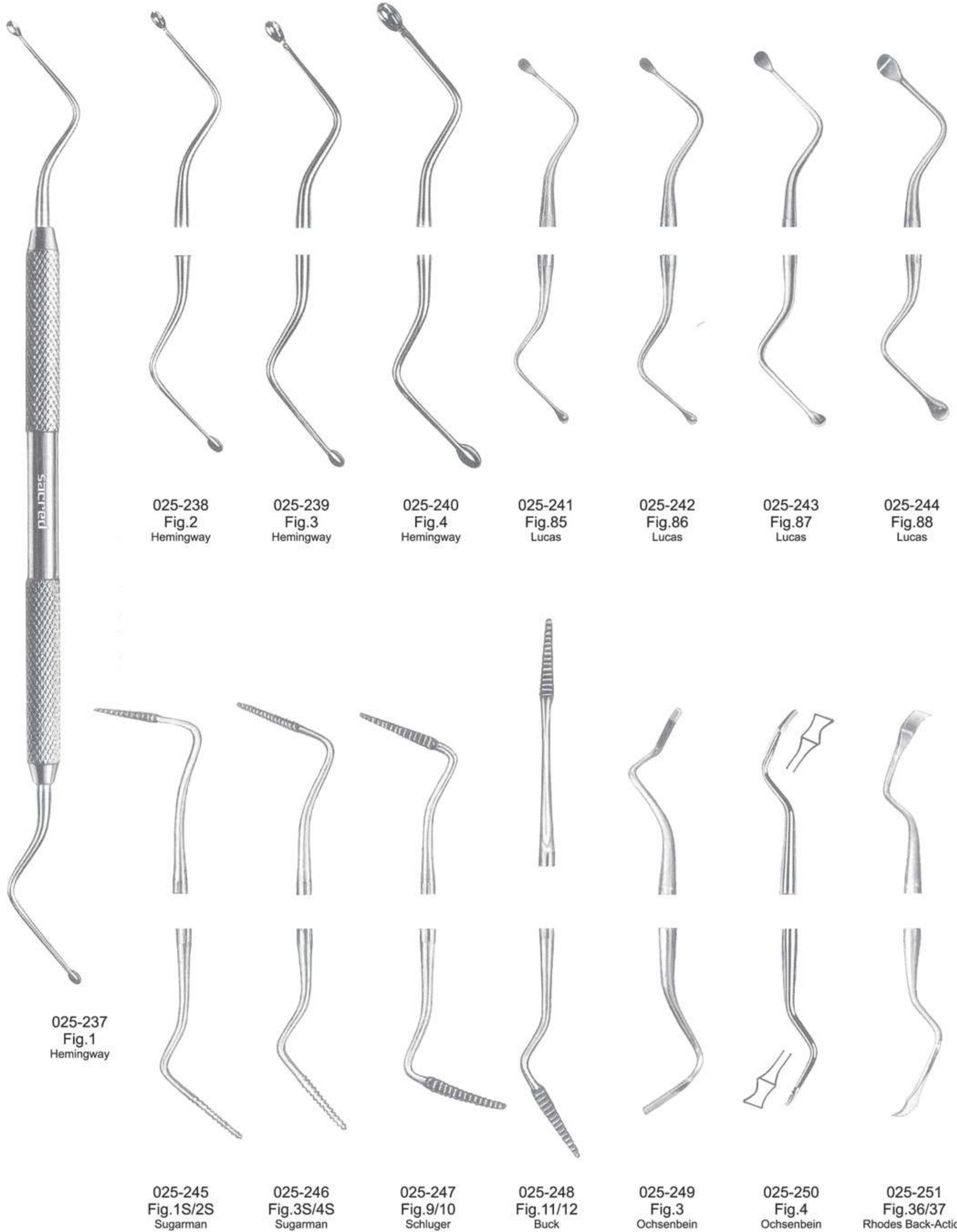



025-252  
Fig.7  
Goldman-Fox



025-253  
Fig.8  
Goldman-Fox



025-254  
Fig.9  
Goldman-Fox

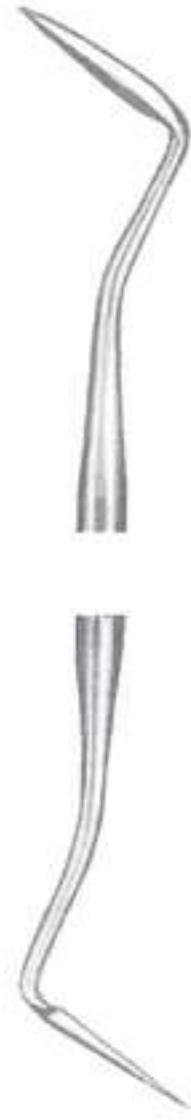

025-255  
Fig.11  
Goldman-Fox



025-256  
Fig.3/4  
Buck



025-257  
Fig.5/6  
Buck

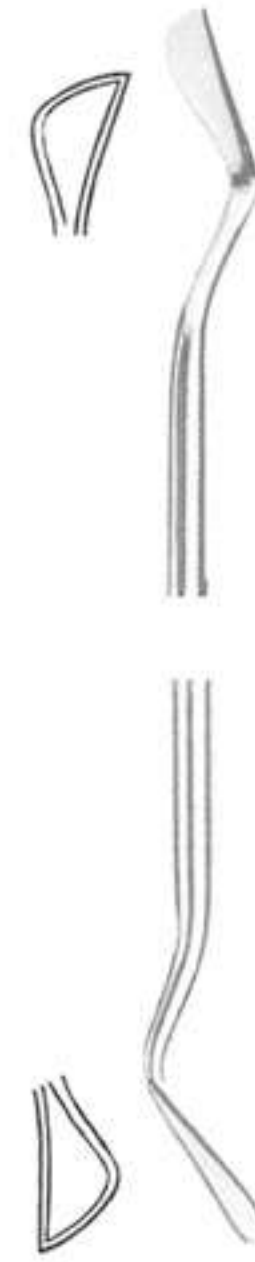

025-258  
Fig.1/2  
(15k/16k)  
Kirkland

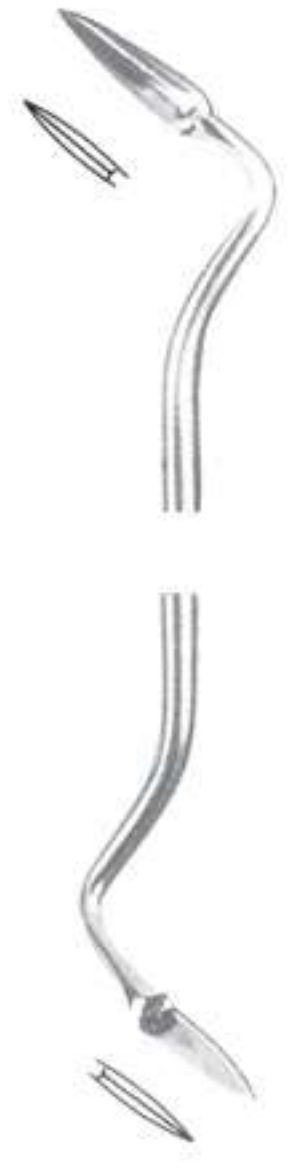

025-259  
Fig.1/2  
Orabn



025-260  
Fig.1/2  
Sanders

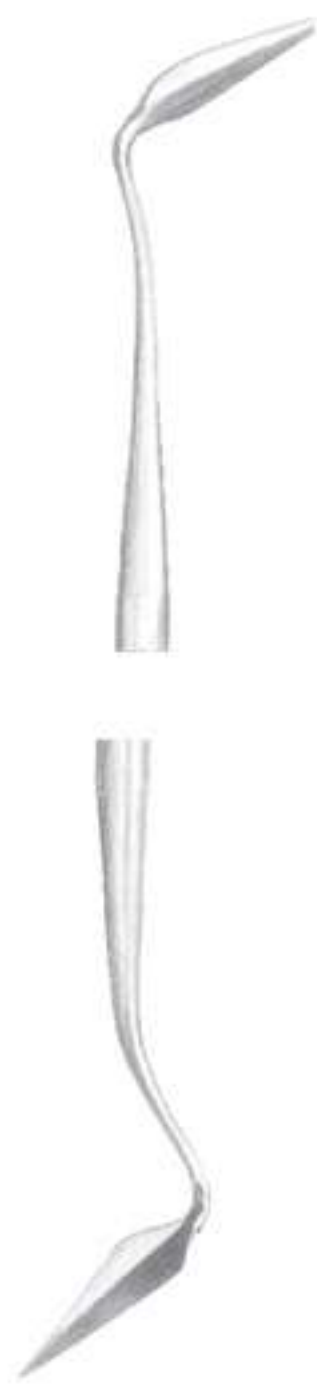

025-261  
Fig.4/5  
Sanders

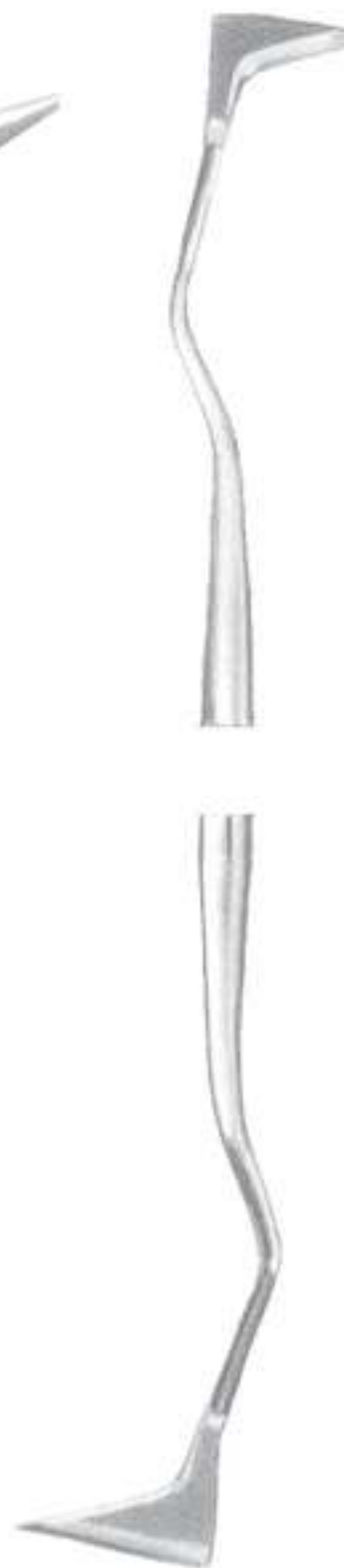

025-262  
Fig.19/20  
(University of South California)  
USC Towner



025-263  
Fig.CK3  
Crane-Kaplan



curettes and scalers

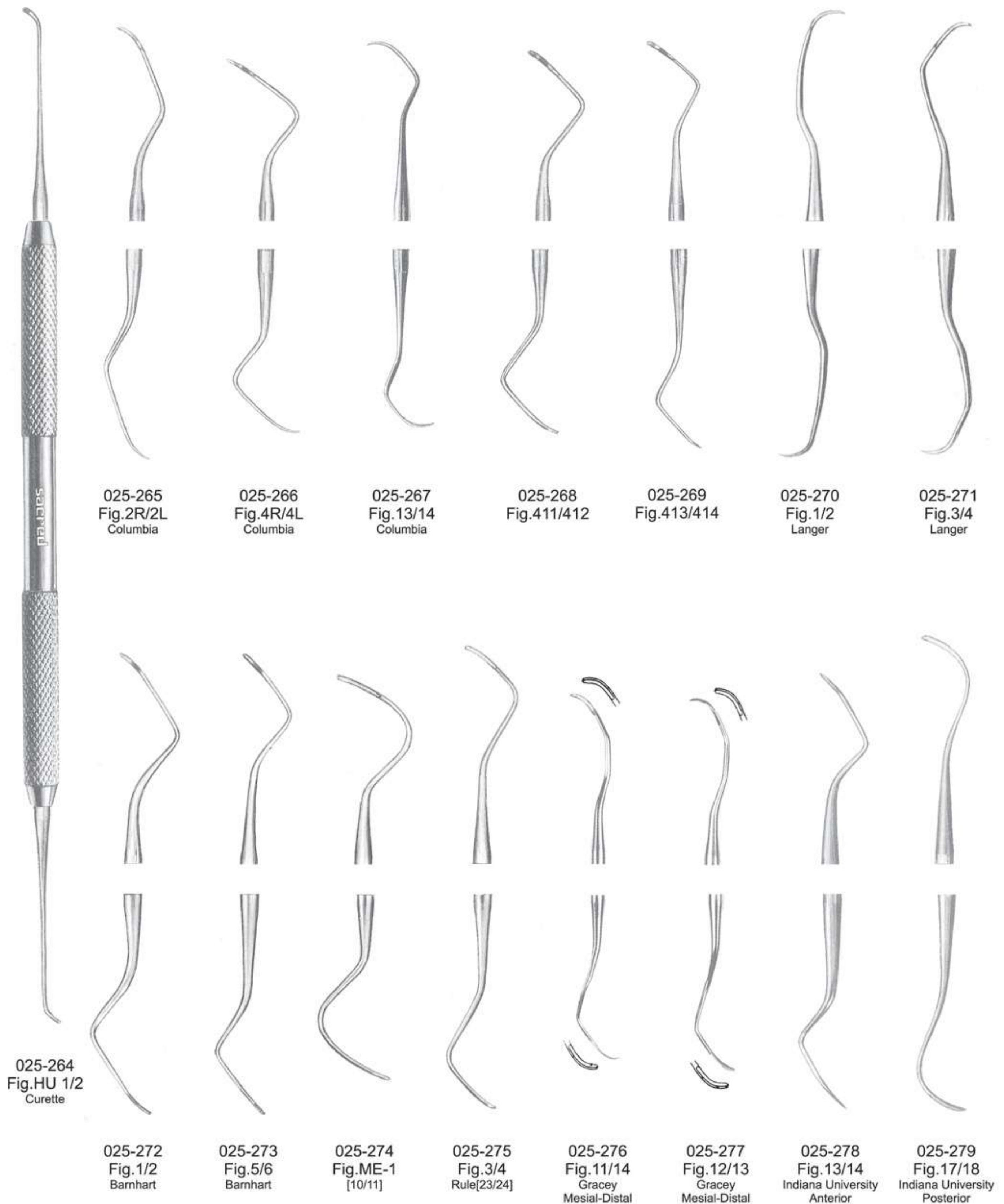



Gracey Curettes  
Set Of 7  
025-280S



Set of 9 025-286AS

Set of 7 025-280S



025-280  
Fig.1/2  
Gracey

025-281  
Fig.3/4  
Gracey

025-282  
Fig.5/6  
Gracey

025-283  
Fig.7/8  
Gracey

025-284  
Fig.9/10  
Gracey

025-285  
Fig.11/12  
Gracey

025-285A  
Fig.13/14  
Gracey

025-286  
Fig.15/16  
Gracey

025-286A  
Fig.17/18  
Gracey

Gracey Curettes are also available in rigid points



Set of 7 025-280SR

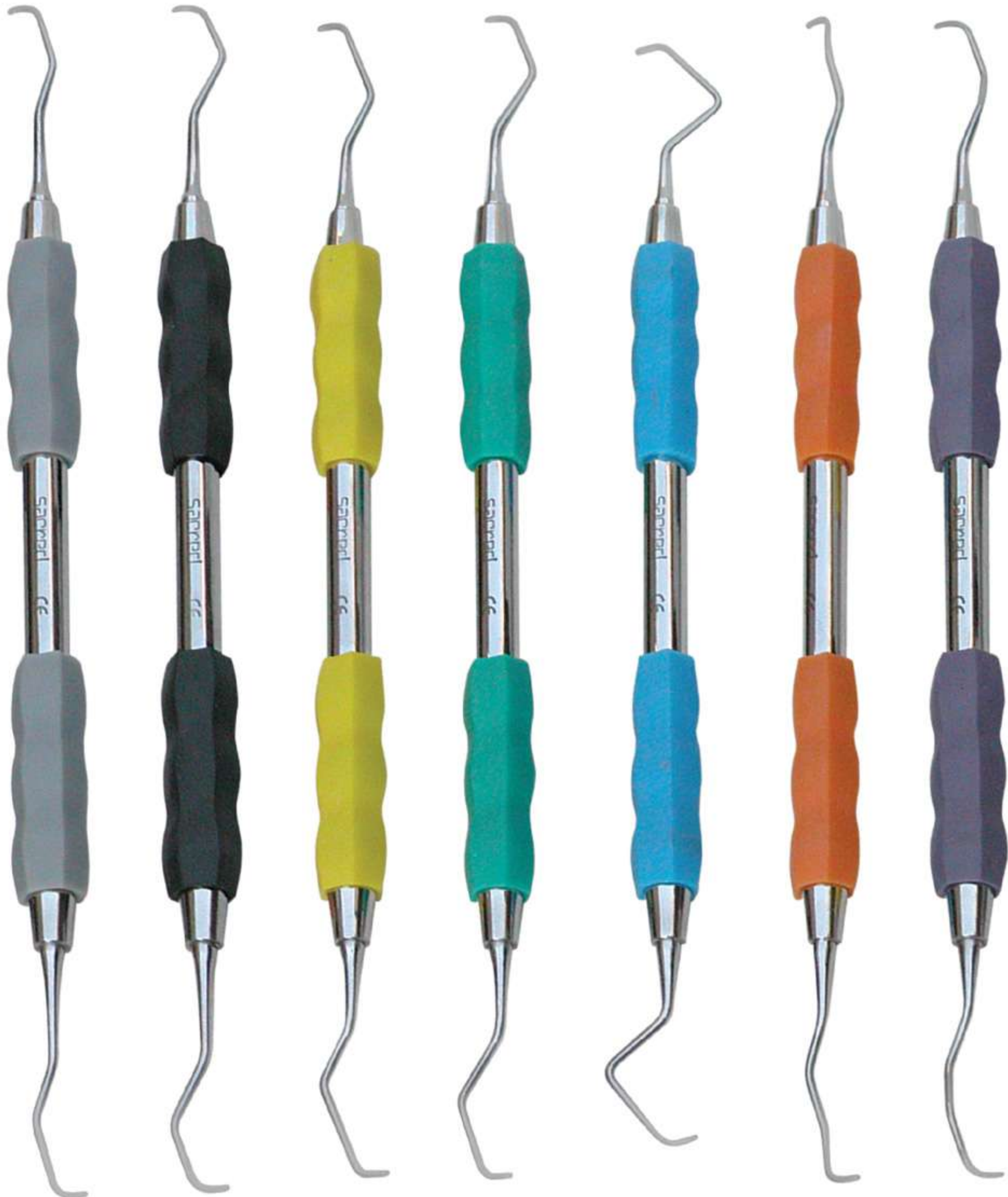

025-280 SR  
Fig.1/2  
Gracey

025-281 SR  
Fig.3/4  
Gracey

025-282 SR  
Fig.5/6  
Gracey

025-283 SR  
Fig.7/8  
Gracey

025-284 SR  
Fig.9/10  
Gracey

025-285 SR  
Fig.11/12  
Gracey

025-286 SR  
Fig.15/16  
Gracey

Gracey Curettes are also available in rigid points





025-401



025-401



025-402



025-403



025-404



025-405



025-406



025-407



025-408



025-409



025-410



025-411



025-412



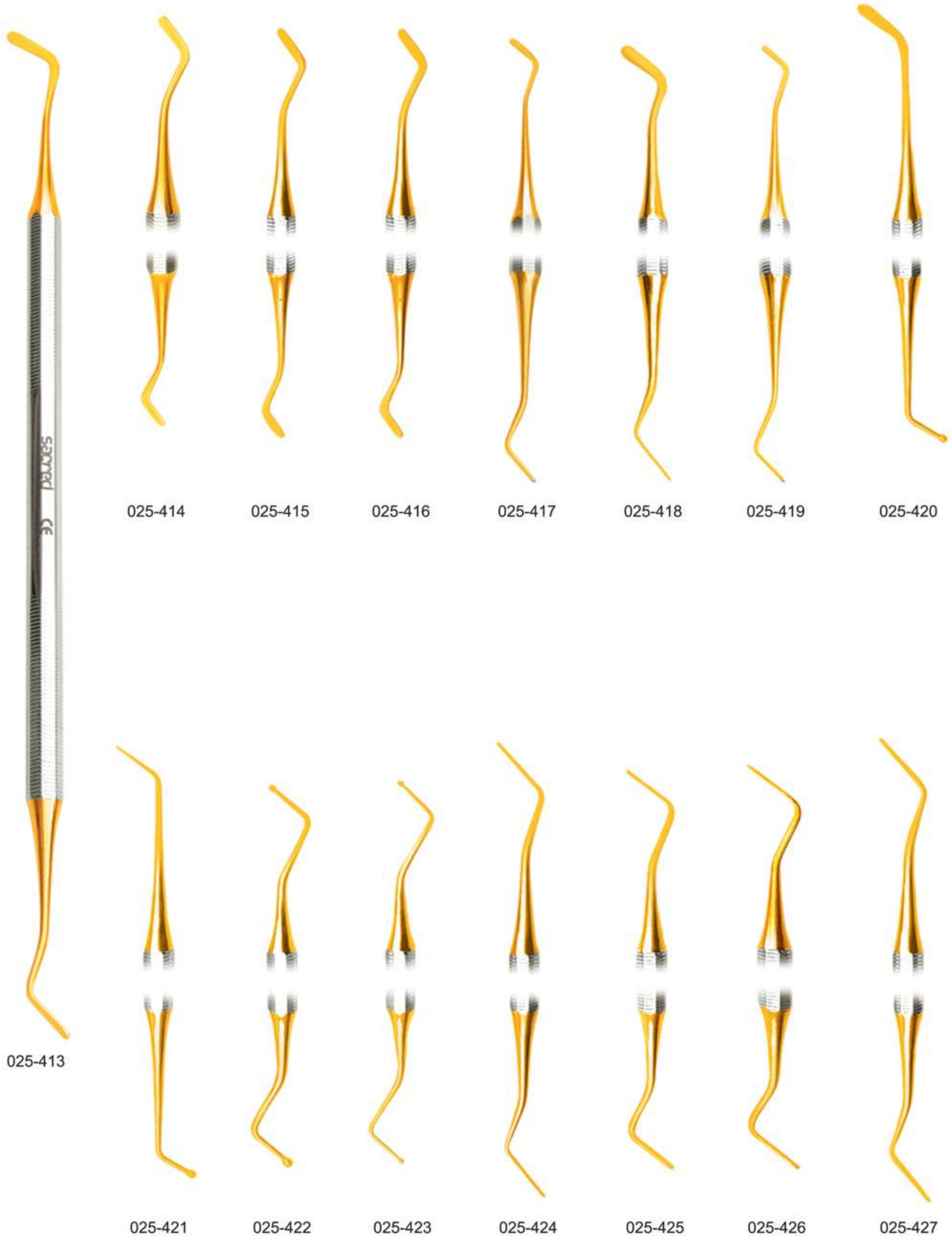

025-414

025-415

025-416

025-417

025-418

025-419

025-420

025-413

025-421

025-422

025-423

025-424

025-425

025-426

025-427



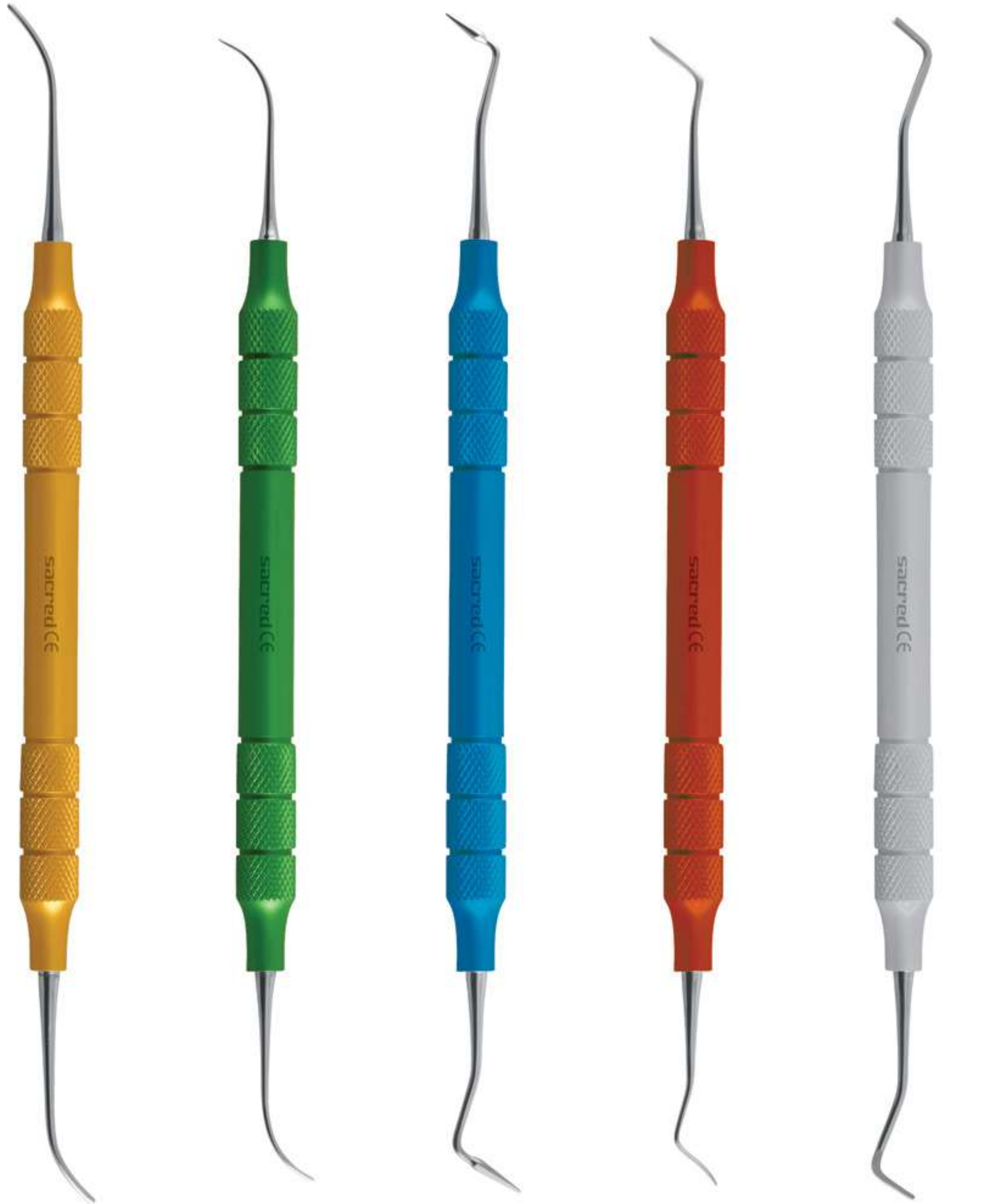

025-366 N  
Fig.1

025-367 N  
Fig.2

**Aluminum Handle**

025-368 N  
Fig.3

025-369 N  
Fig.4

025-370 N  
Fig.5

**Stainless Steel Handle**

025-366  
P.K. Thomas  
Fig.1

025-367  
P.K. Thomas  
Fig.2

025-368  
P.K. Thomas  
Fig.3

025-369  
P.K. Thomas  
Fig.4

025-370  
P.K. Thomas  
Fig.5



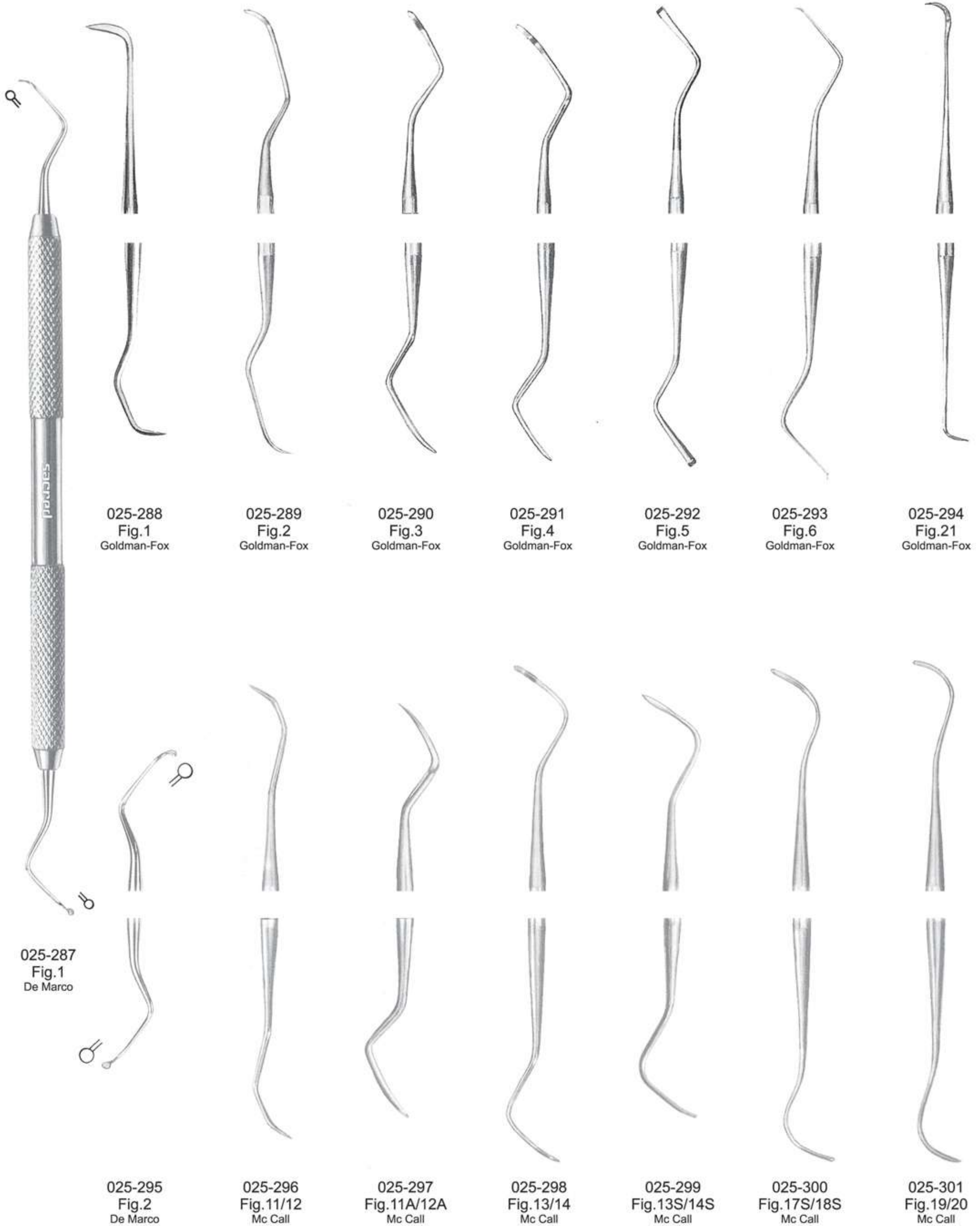









025-500 S  
Complete Set Composed of 1 handle & 20 interchangeable tips



Fig-0 Fig-1 Fig-2 Fig-3 Fig-4 Fig-5 Fig-6 Fig-7

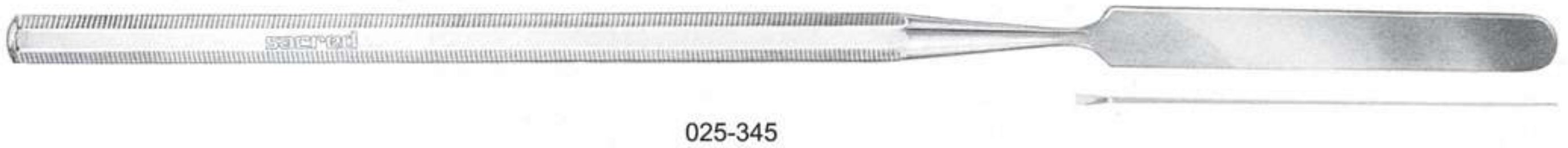
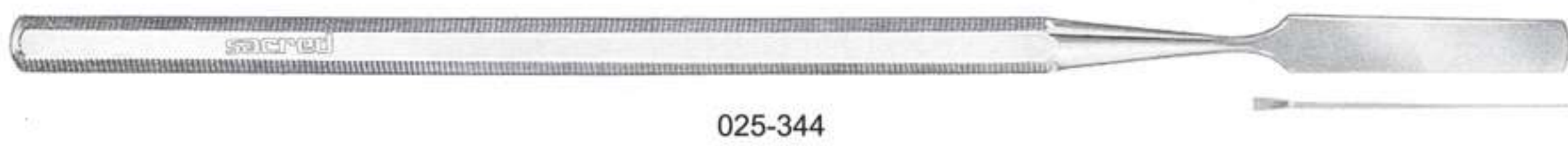
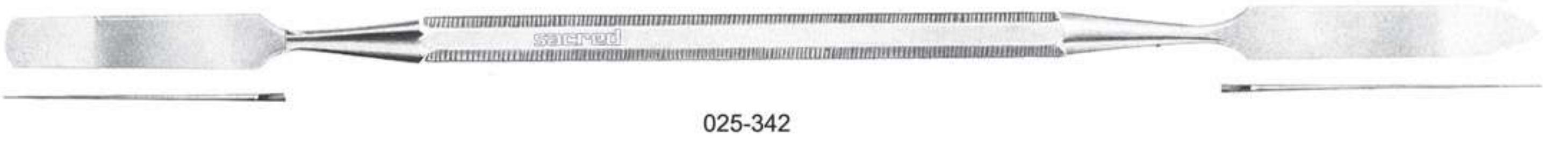
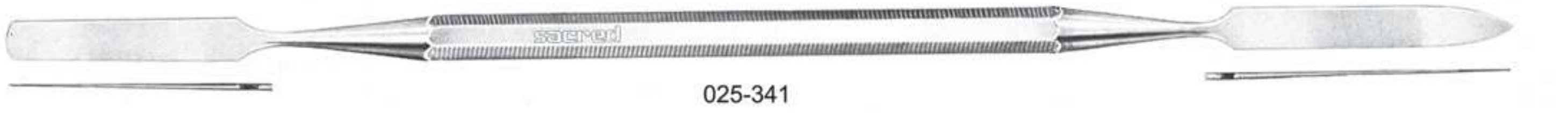
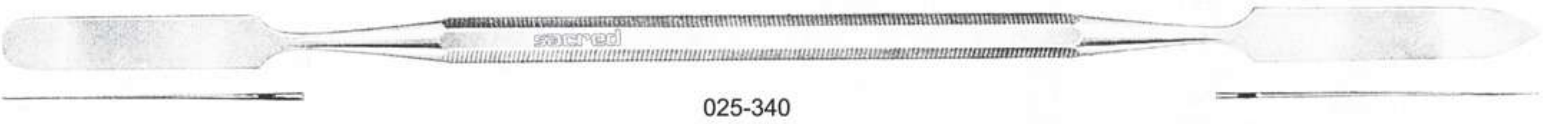
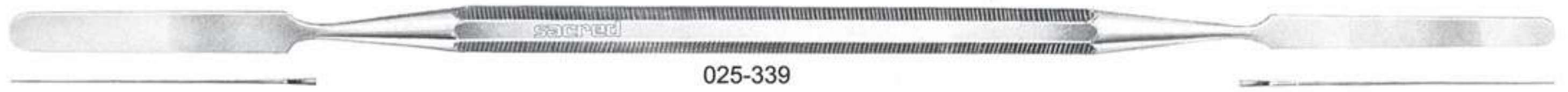

Fig-8 Fig-9 Fig-11 Fig-21 Fig-22 Fig-23



Fig-24 Fig-25 Fig-26 Fig-27 Fig-28 Fig-29









025-350  
Zahle



025-351  
Zahle



025-352  
Zahle



025-353  
Hylin



025-354  
Hylin-Ceramica



025-355  
Hylin-Sacred



025-356  
Hylin-Le Cron



025-357  
Sacred





025-358  
Le Cron

025-359  
Le Cron



025-360  
Vehe



025-361  
Beale



025-362  
Roach



025-363  
Le Cron



025-364  
Le Cron



025-365  
Gritman



025-371  
Fig.1  
Fahnenstock  
cm. 12,5



025-372  
Fig.1  
Lessmann  
cm. 12,5



025-373  
Fig.1  
Con Scodellino  
cm. 12,5



025-374  
Fig.2  
Fahnenstock  
cm. 17



025-375  
Fig.2  
Lessmann  
cm. 17



025-376  
Fig.2  
Con Scodellino  
cm. 17





025-377  
cm. 17



025-378  
cm. 17 Gritman



025-379  
cm. 19,5

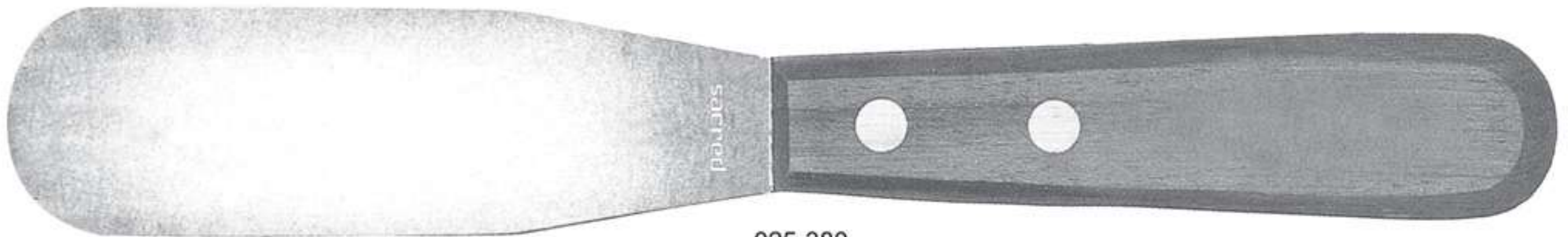

025-380  
cm. 21,5



025-381  
cm. 20,5



025-382  
cm. 19,5



025-383  
cm. 20

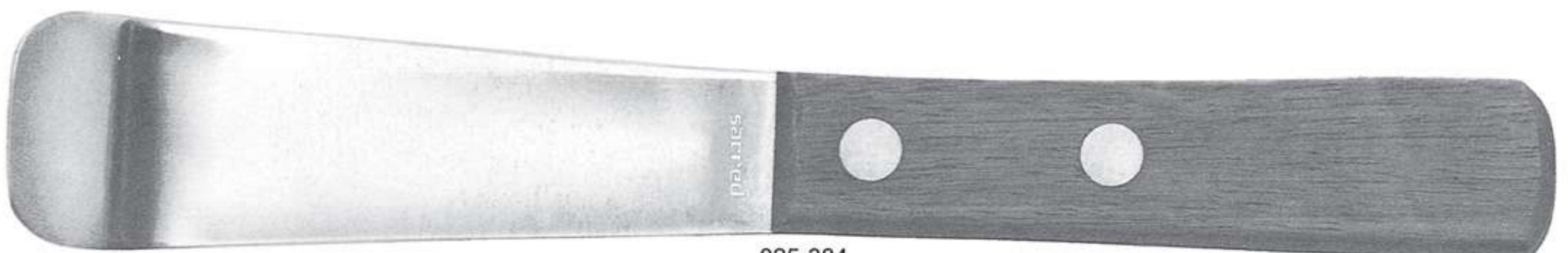

025-384  
cm. 22,5



Extracting Forceps  
Set of 10  
050-200S  
Consists:  
Fig.1, Fig.7, Fig.17,  
Fig.18, Fig.79, Fig.13,  
Fig.33A, Fig.51A,  
Fig.67A, Fig.22

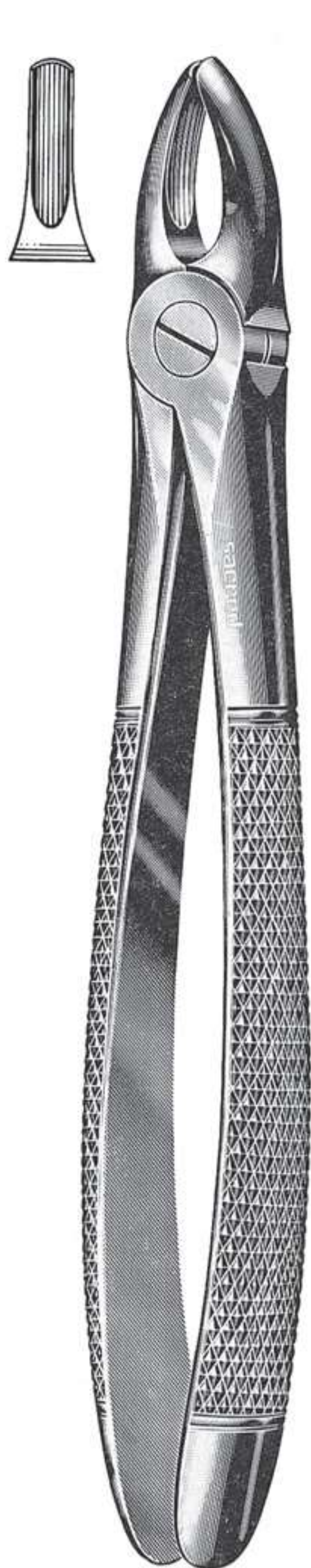

050-001  
Fig.1  
Upper centrals  
& canines

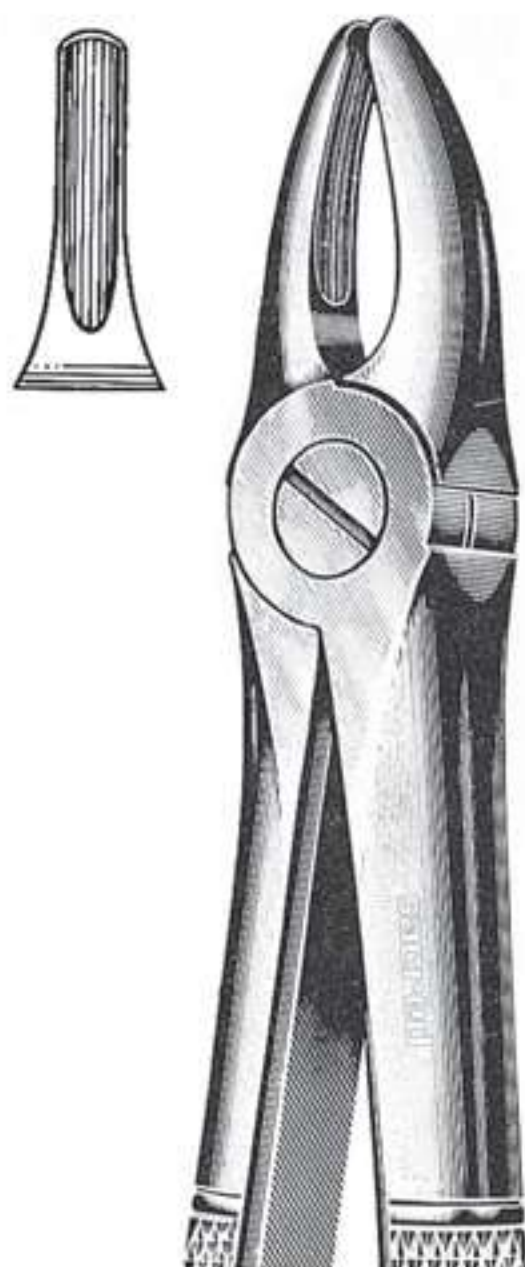

050-002  
Fig.2  
Upper laterals  
& bicuspid

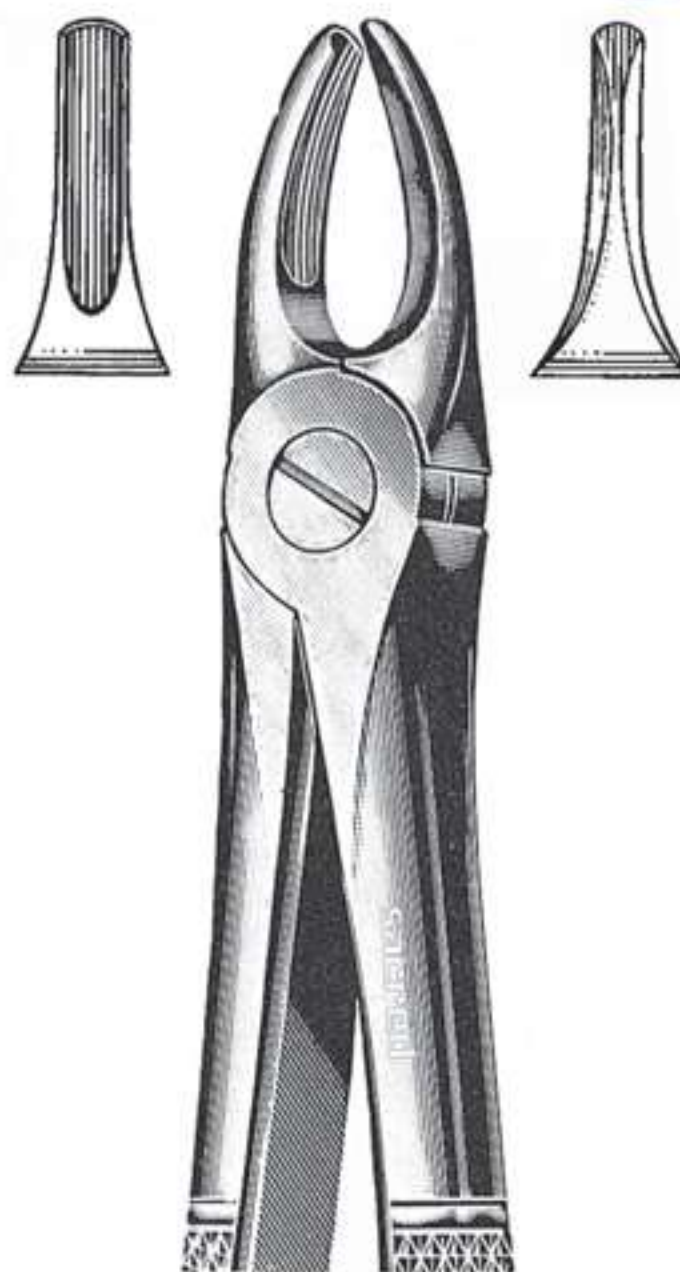

050-003  
Fig.3  
Upper incisors  
& canines

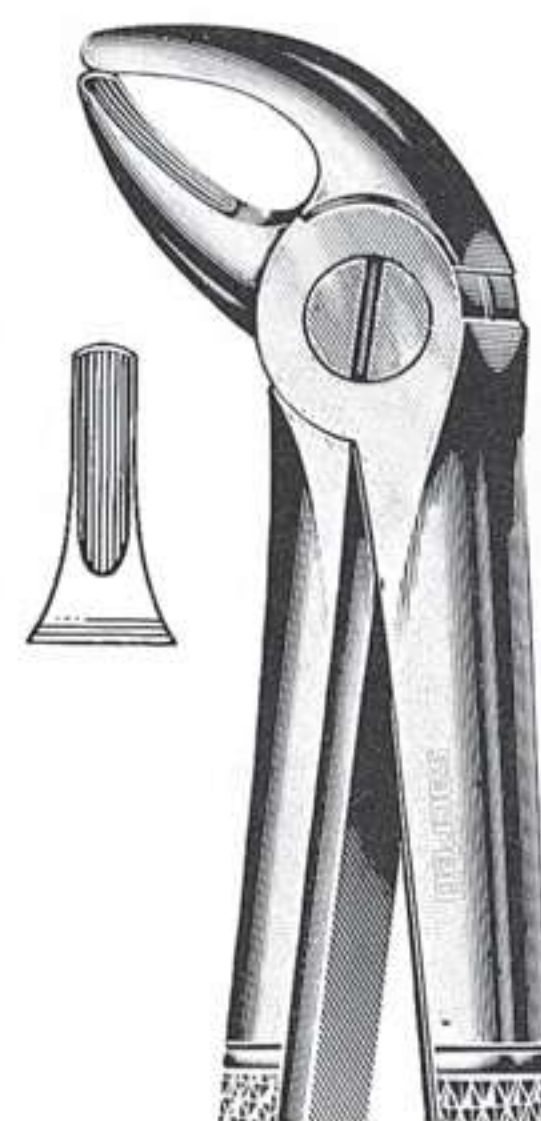

050-004  
Fig.4  
Lower incisors  
& Canines

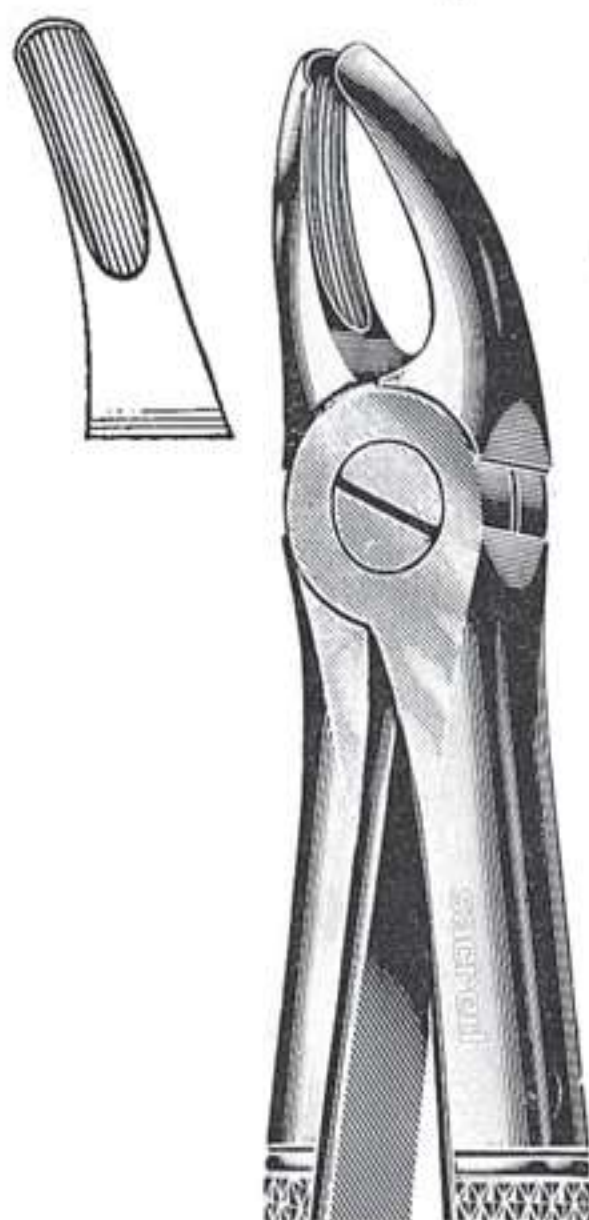

050-005  
Fig.7  
Upper primolars

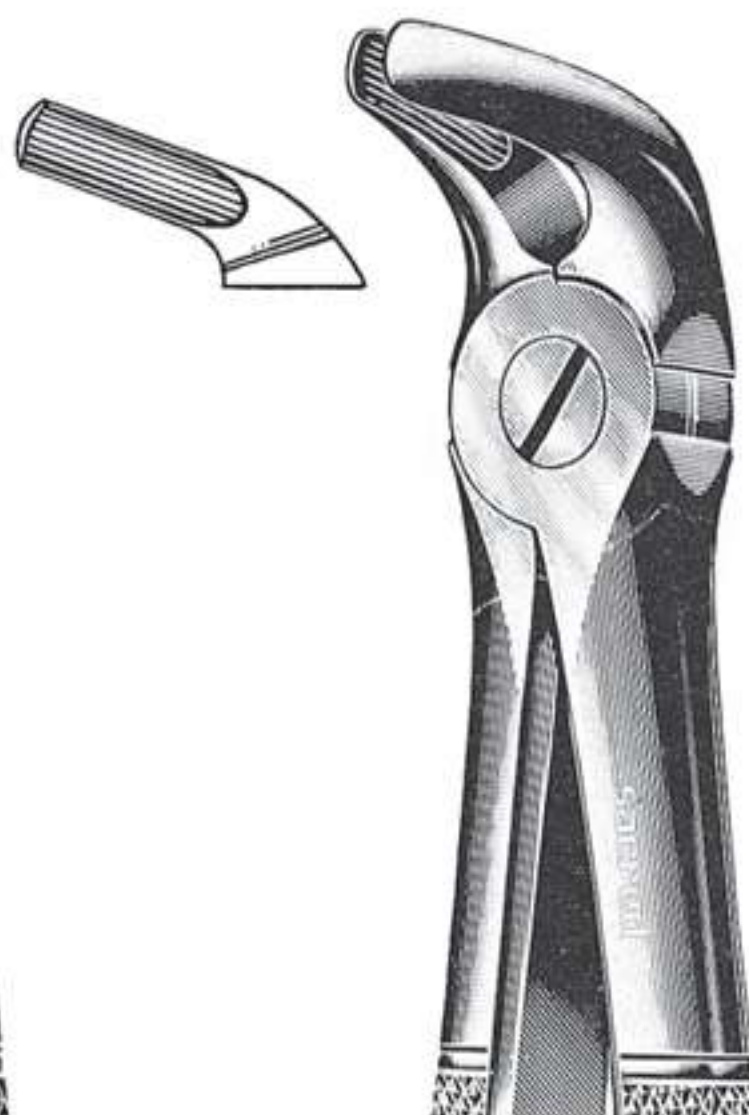

050-006  
Fig.8  
Lower primolars

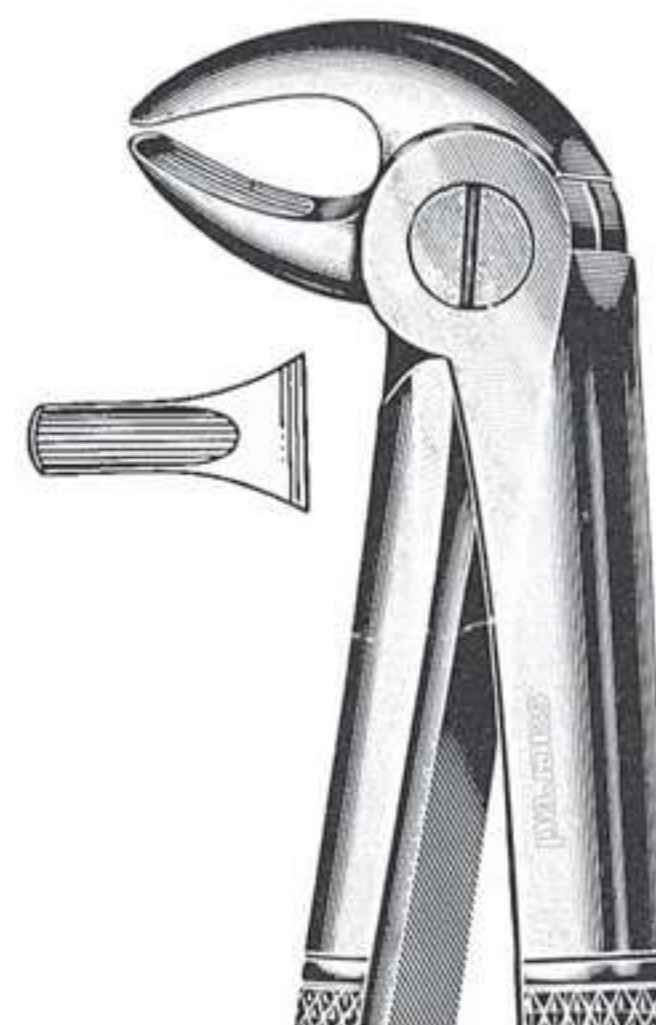

050-007  
Fig.13  
Lower primolars





050-008  
Fig.17  
Right upper molars

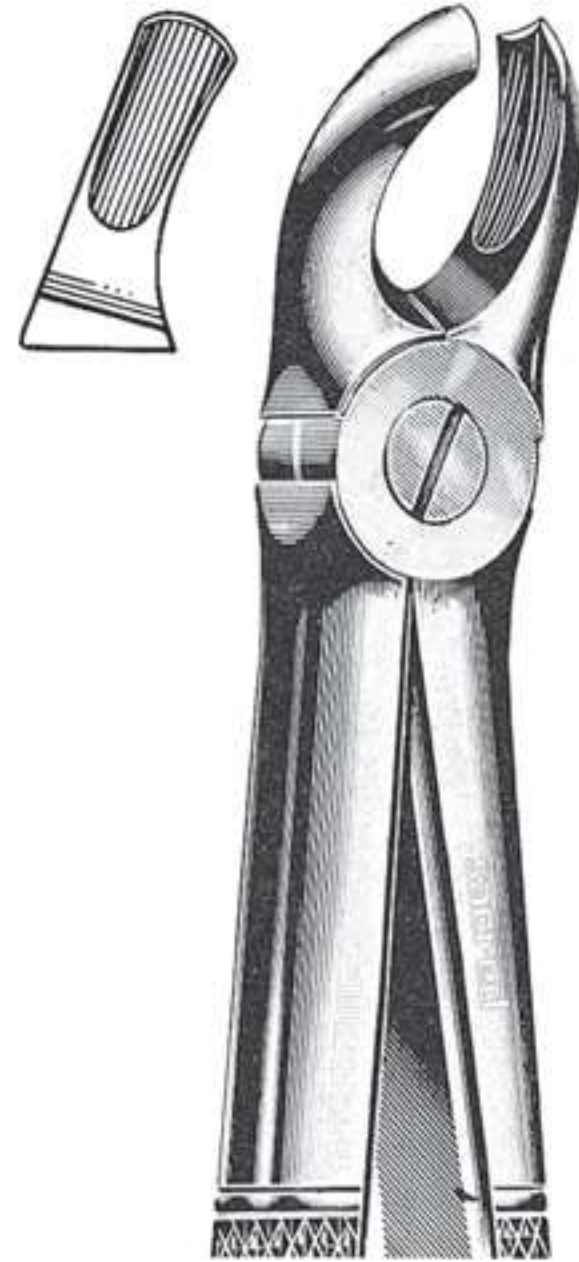

050-009  
Fig.18  
Left upper molars

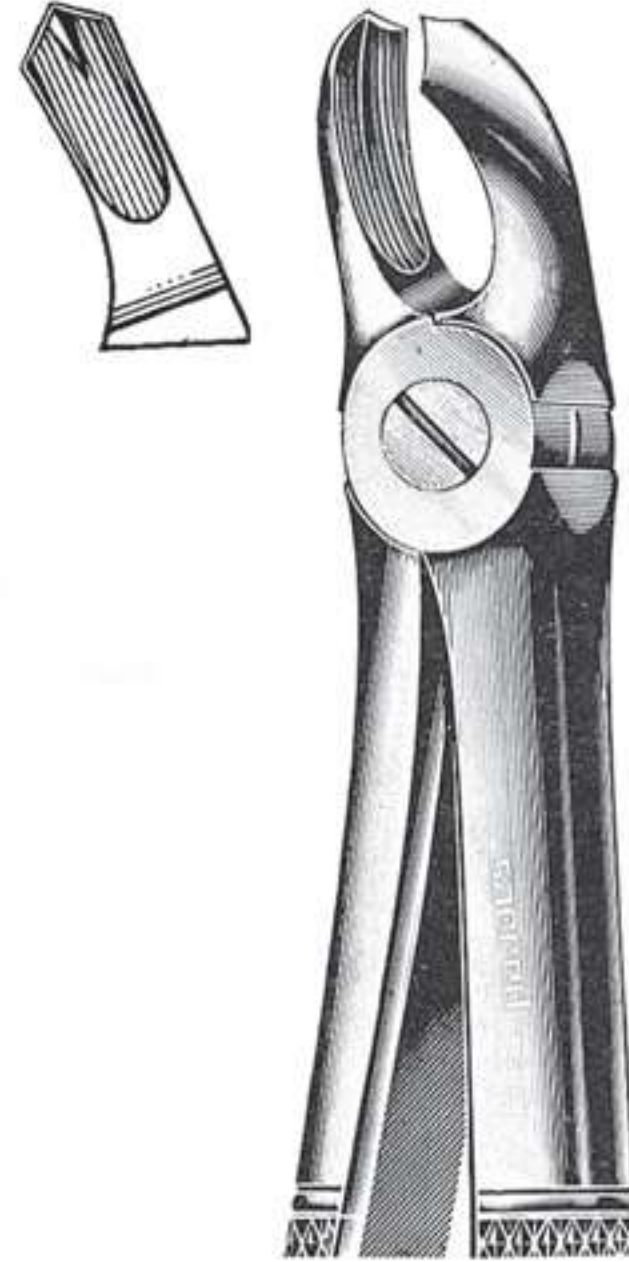

050-010  
Fig.18A  
Upper molars

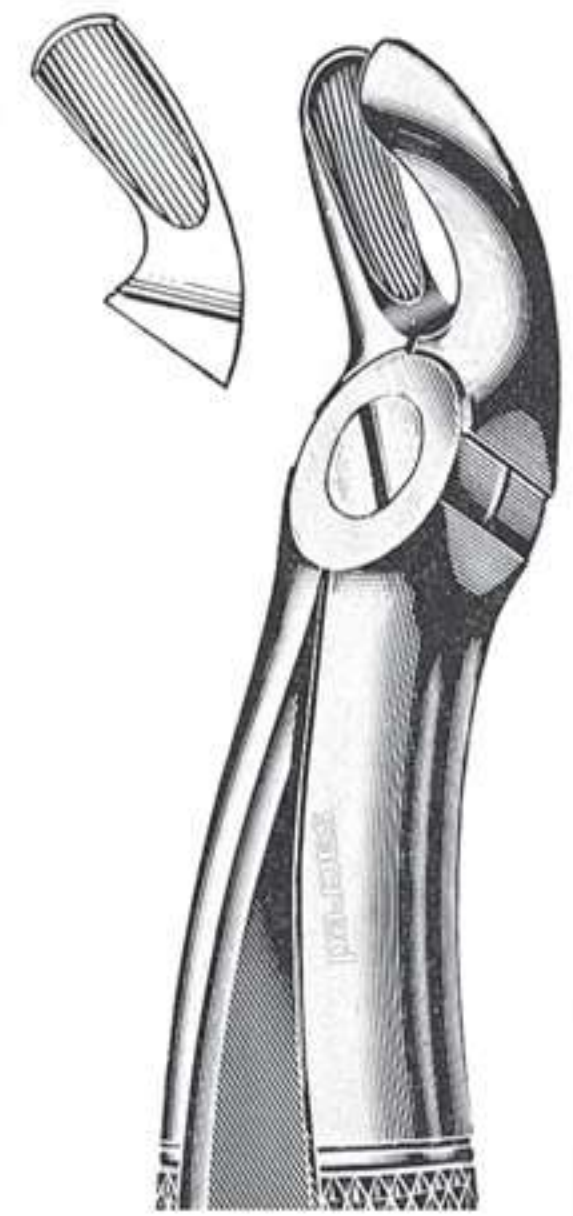

050-011  
Fig.19  
Upper wisdoms



050-012  
Fig.20  
Lower wisdoms

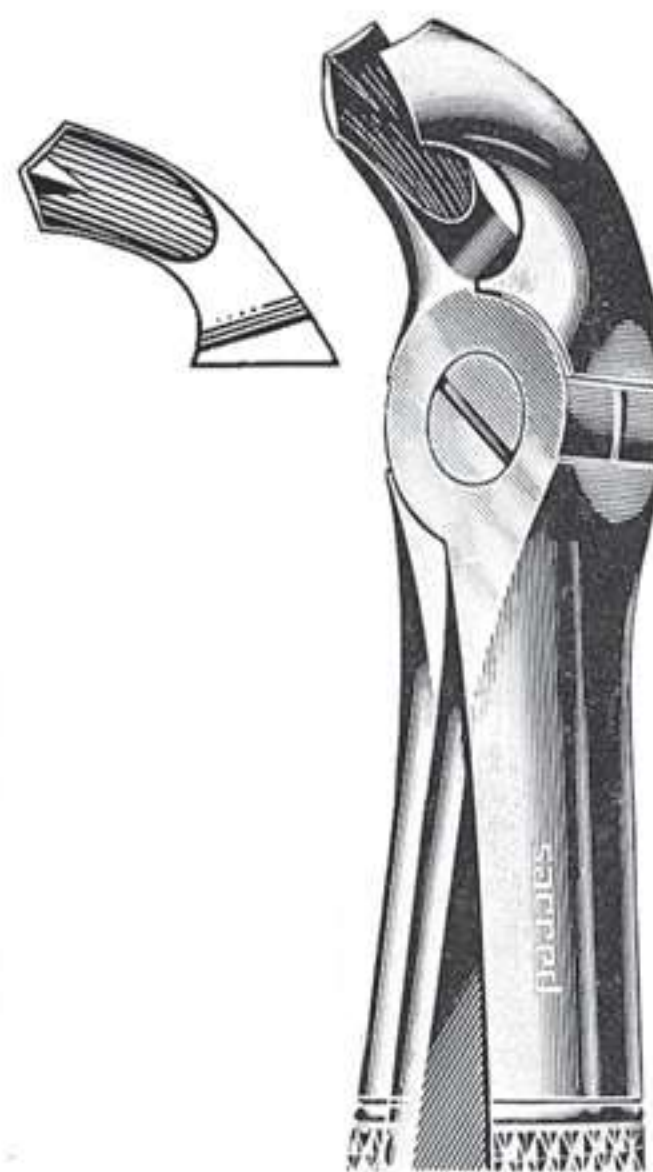

050-013  
Fig.21  
Lower molars

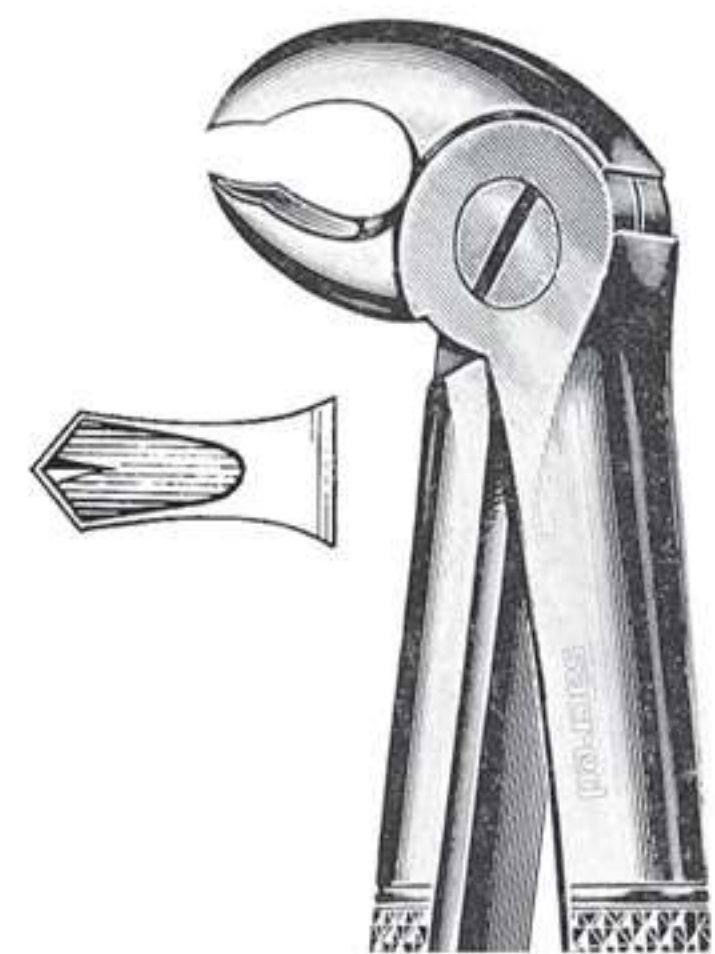

050-014  
Fig.22  
Lower molars  
Hawk's bill





050-015  
Fig.23  
Right lower molars



050-016  
Fig.24  
Left lower molars

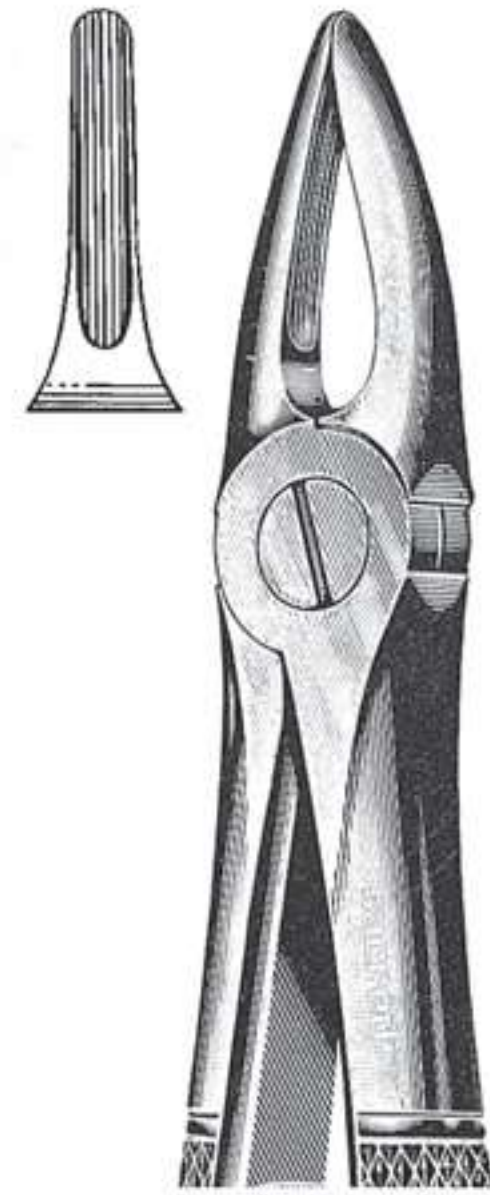

050-017  
Fig.29  
Upper roots  
& incisors

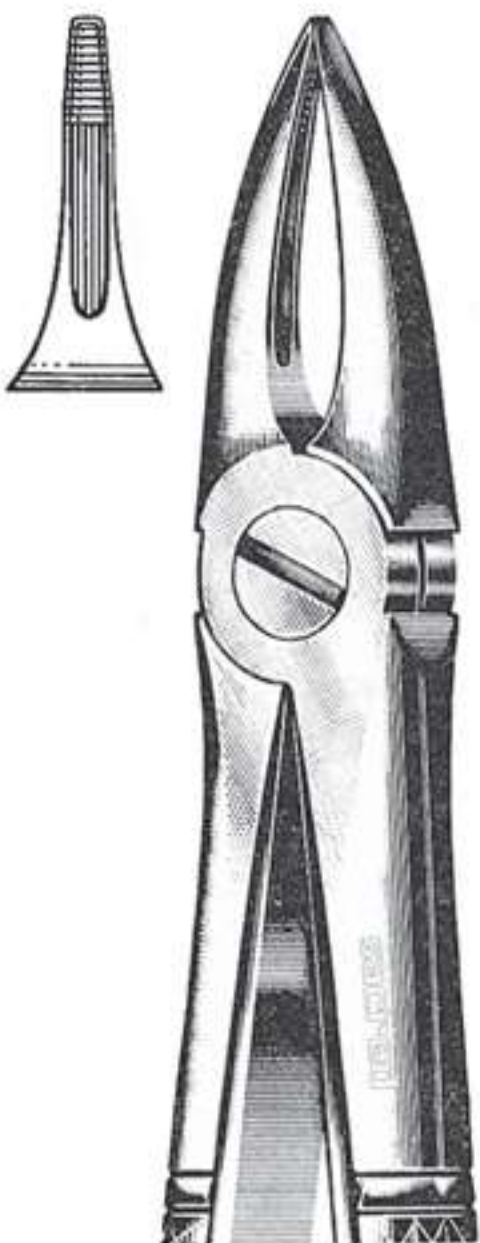

050-018  
Fig.29N  
Roots of upper  
incisors

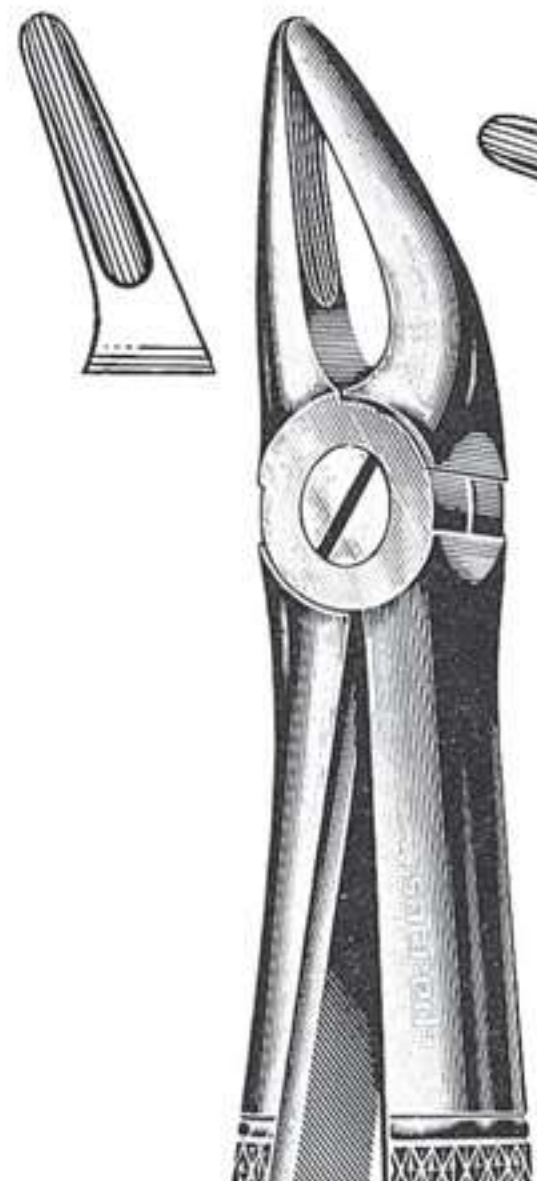

050-019  
Fig.30  
Upper roots &  
incisors

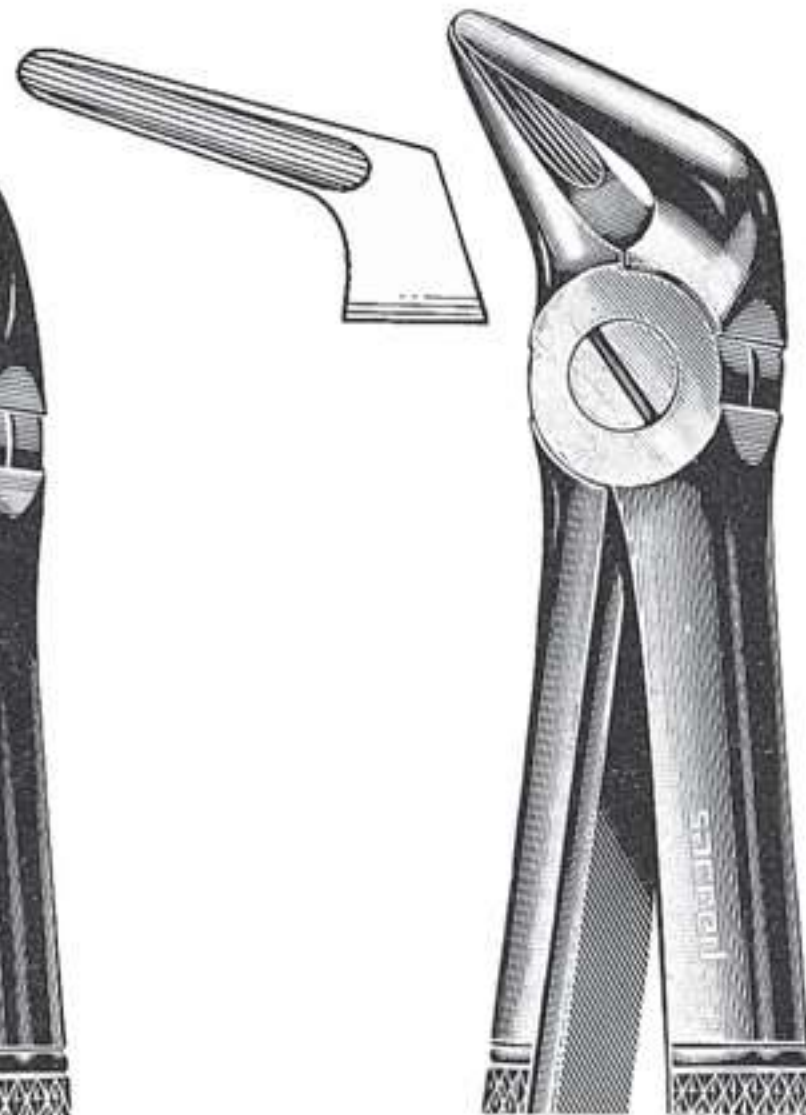

050-020  
Fig.31  
Lower roots



050-021  
Fig.32  
Lower molars



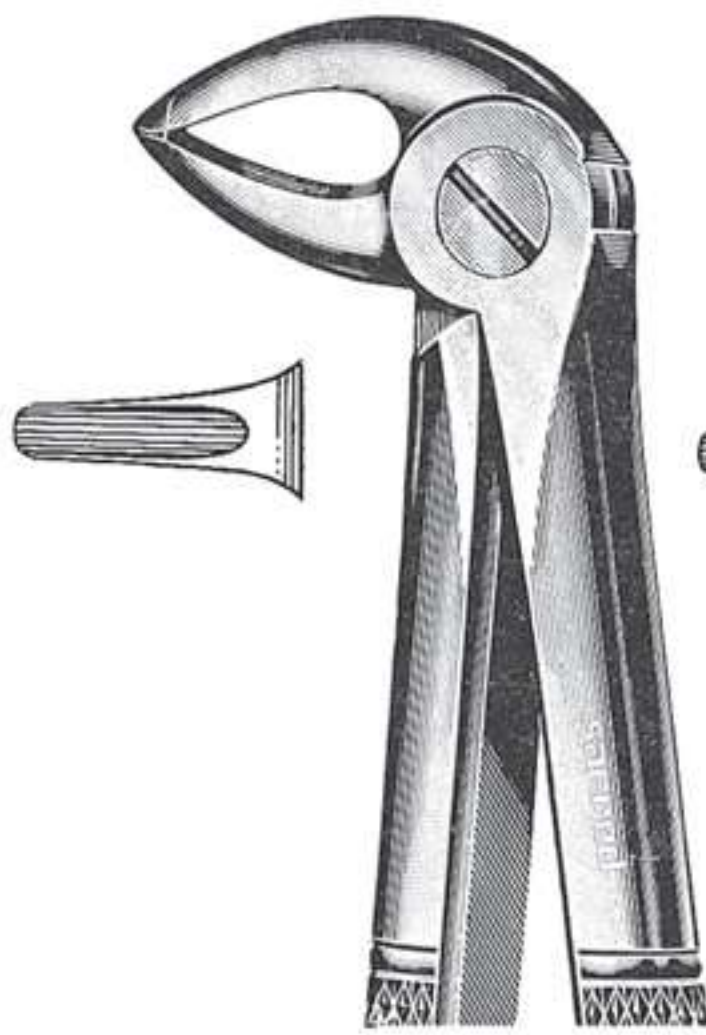

050-022  
Fig.33  
Lower roots

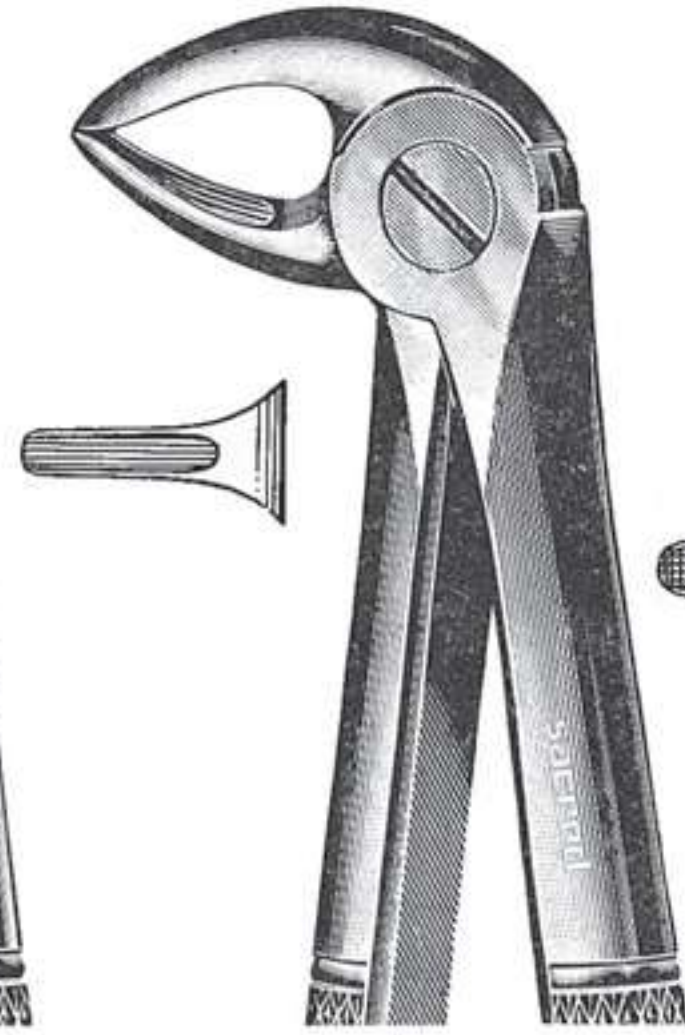

050-023  
Fig.33A  
Lower roots

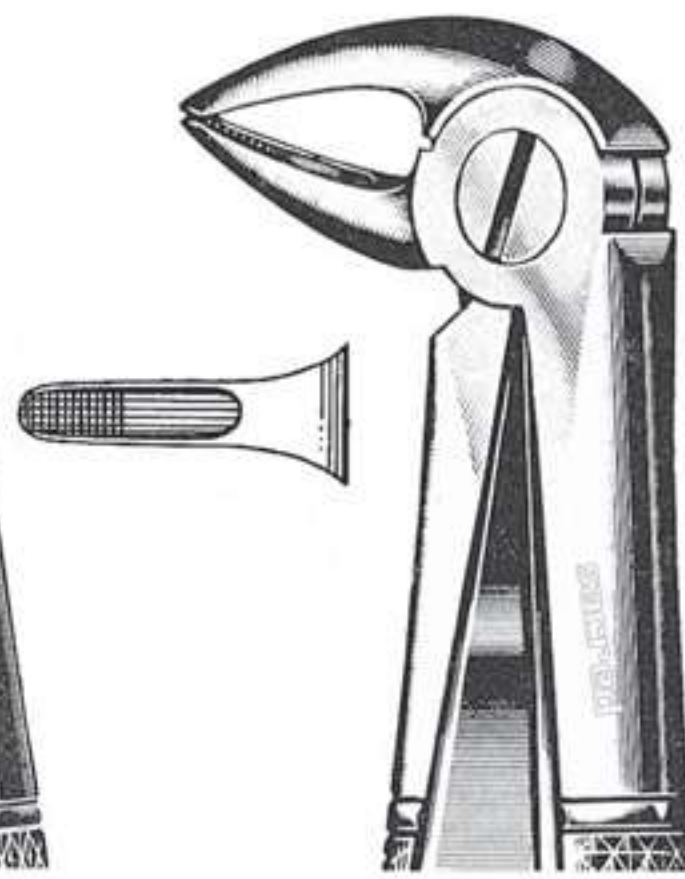

050-024  
Fig.33C  
Lower roots

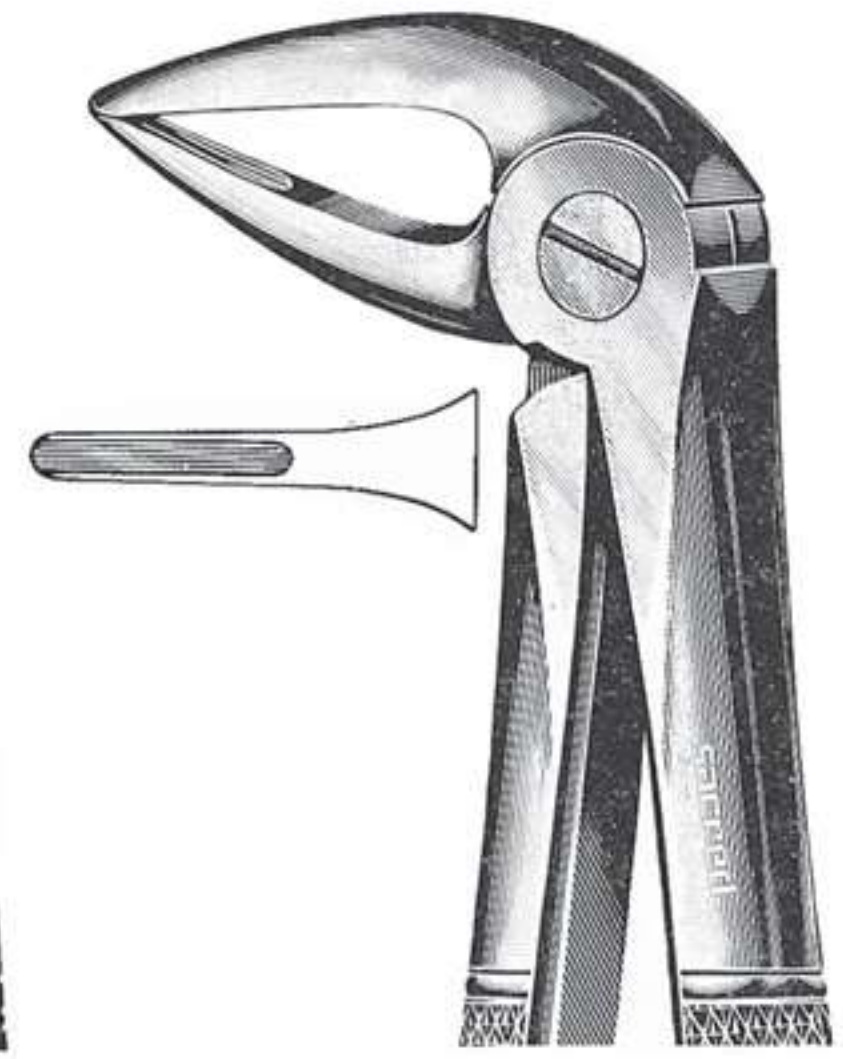

050-025  
Fig.33M  
Lower roots  
with long beak

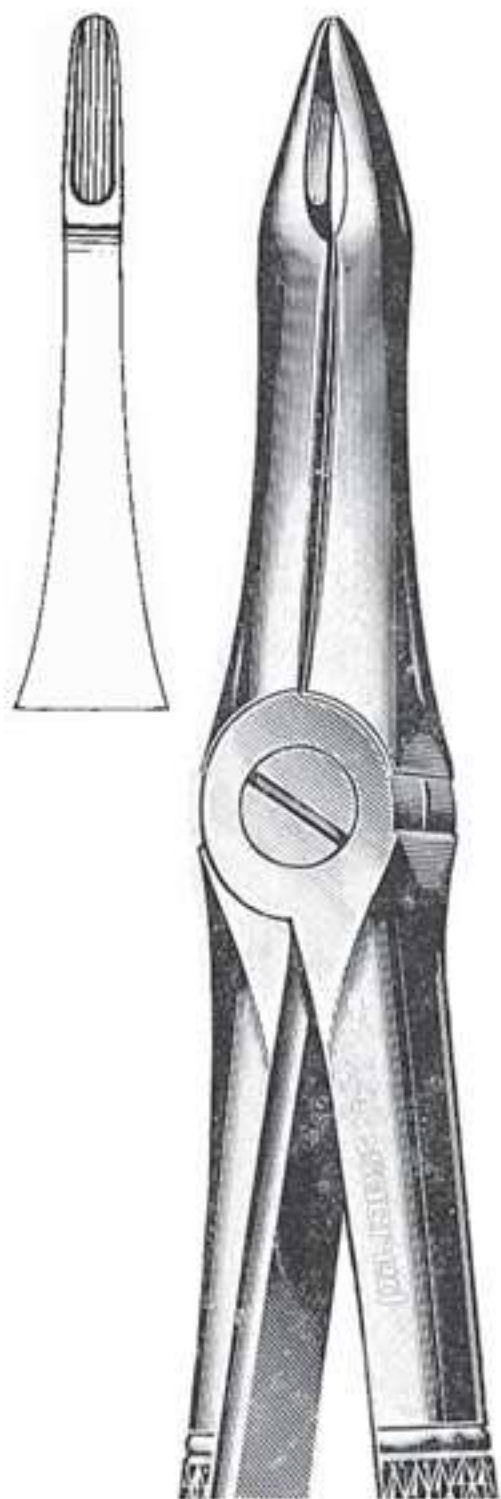

050-026  
Fig.41  
Upper roots

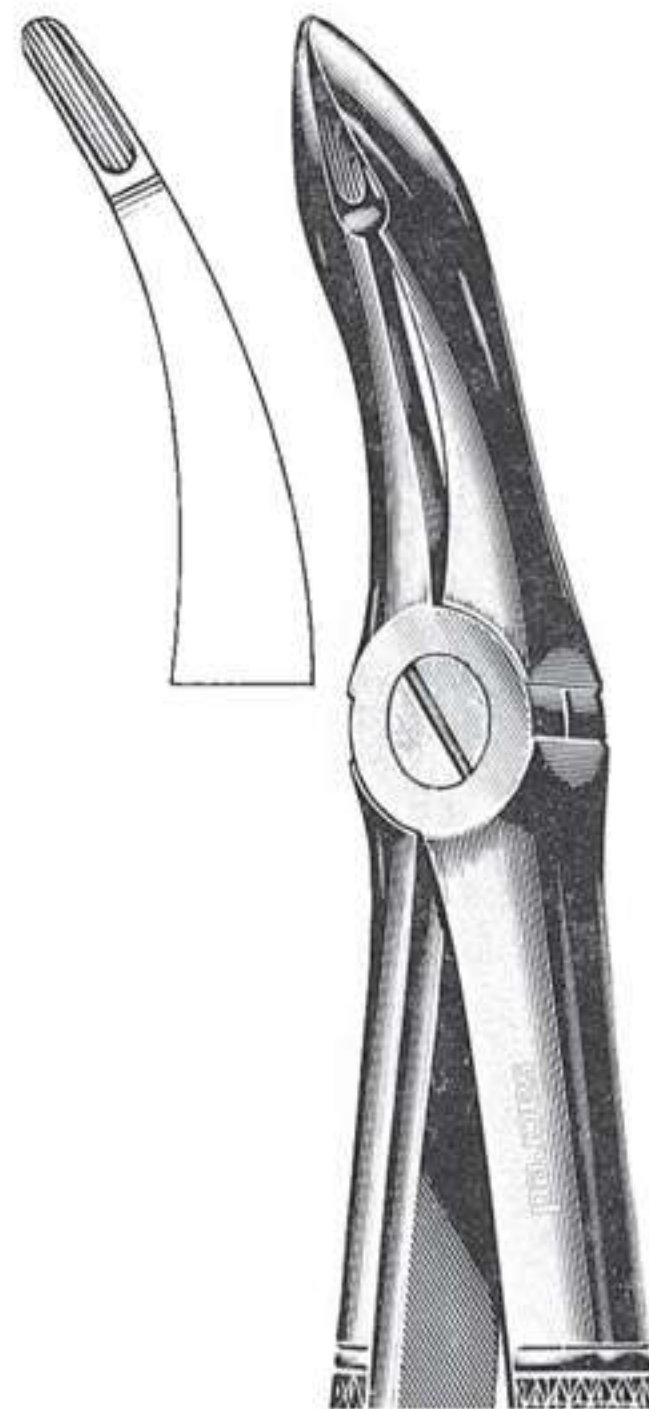

050-027  
Fig.44  
Upper roots

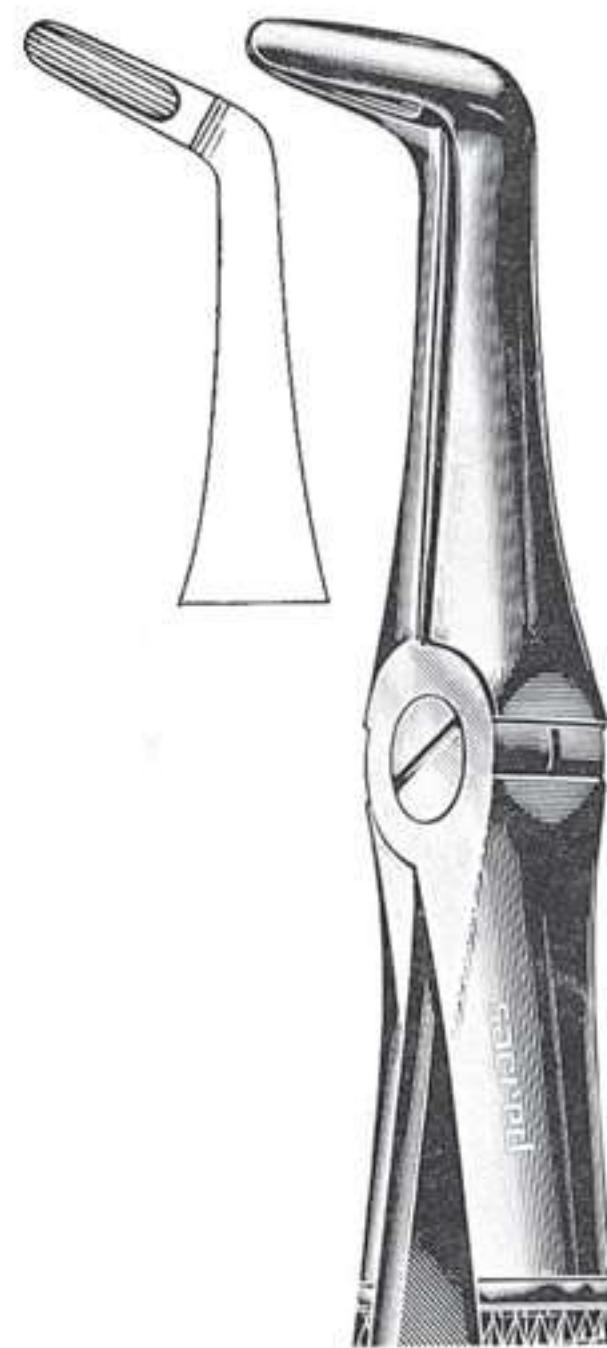

050-028  
Fig.45  
Lower roots

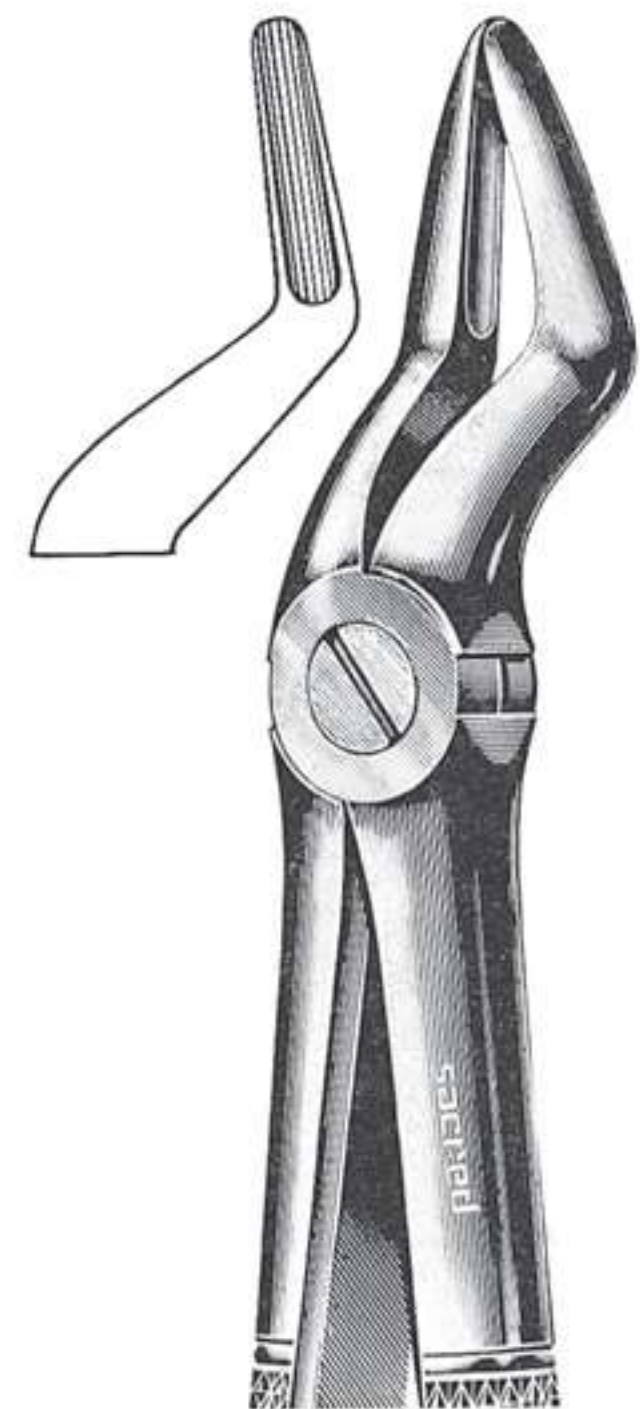

050-029  
Fig.51  
Upper roots



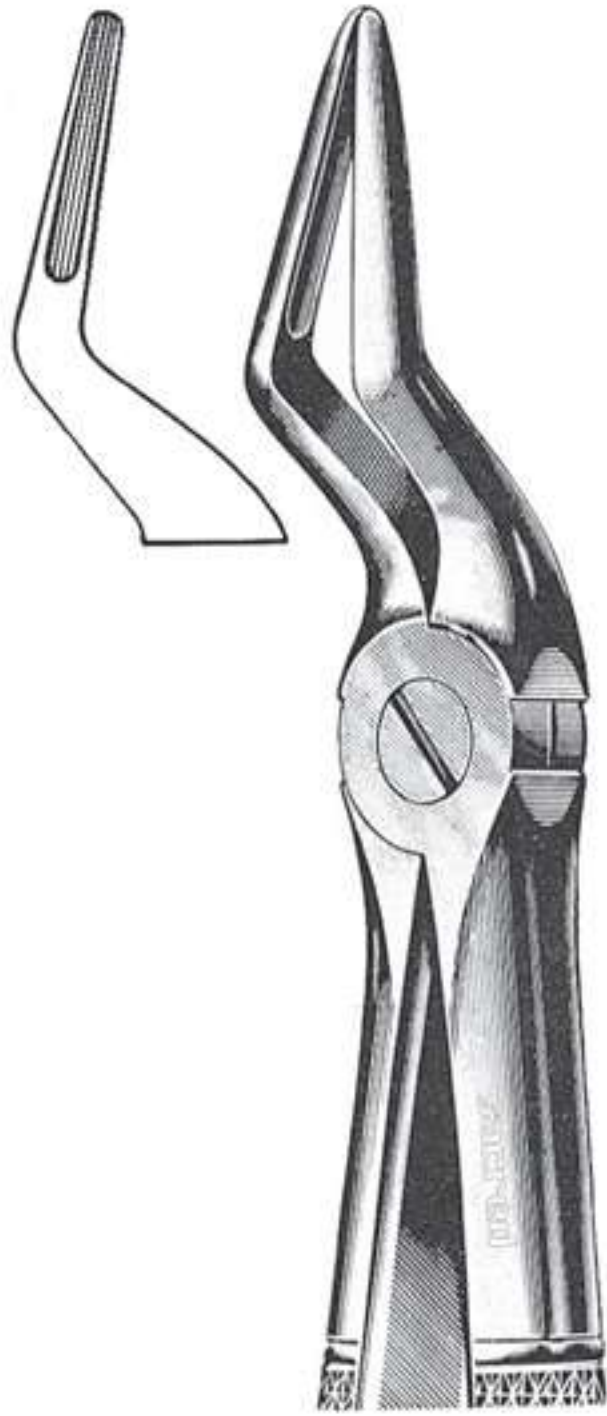

050-030  
Fig.51A  
Upper roots  
narrow beak

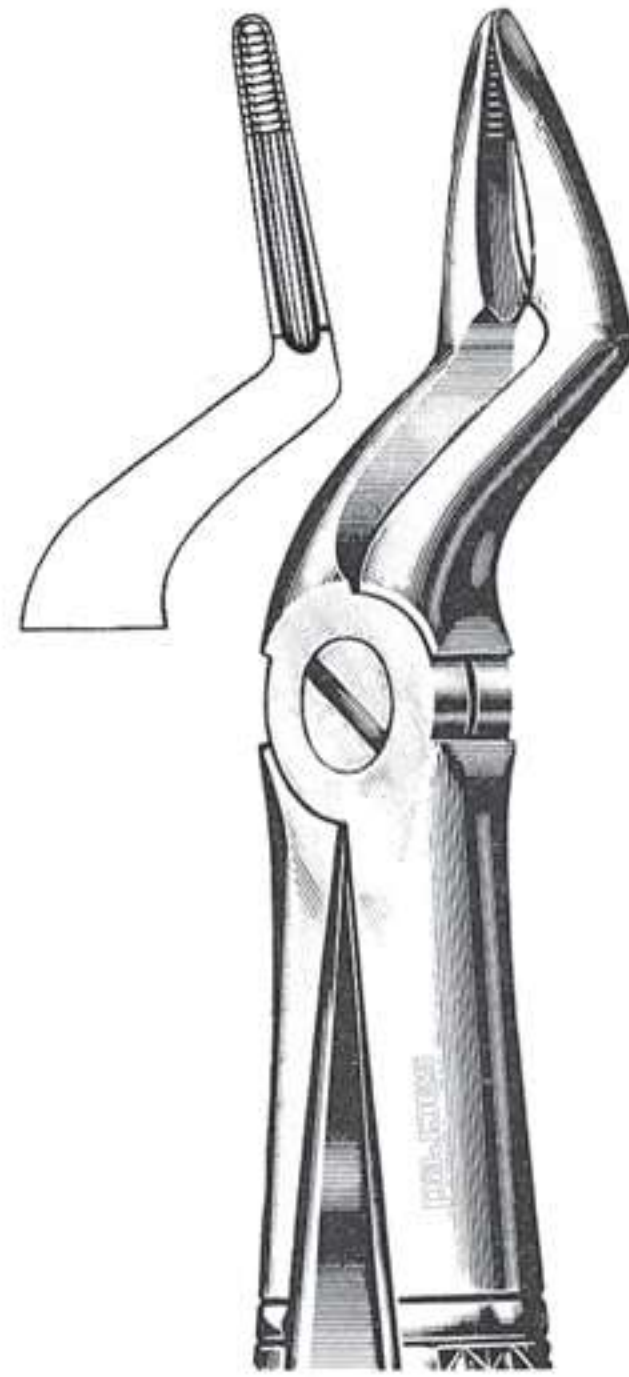

050-031  
Fig.51C  
Upper roots

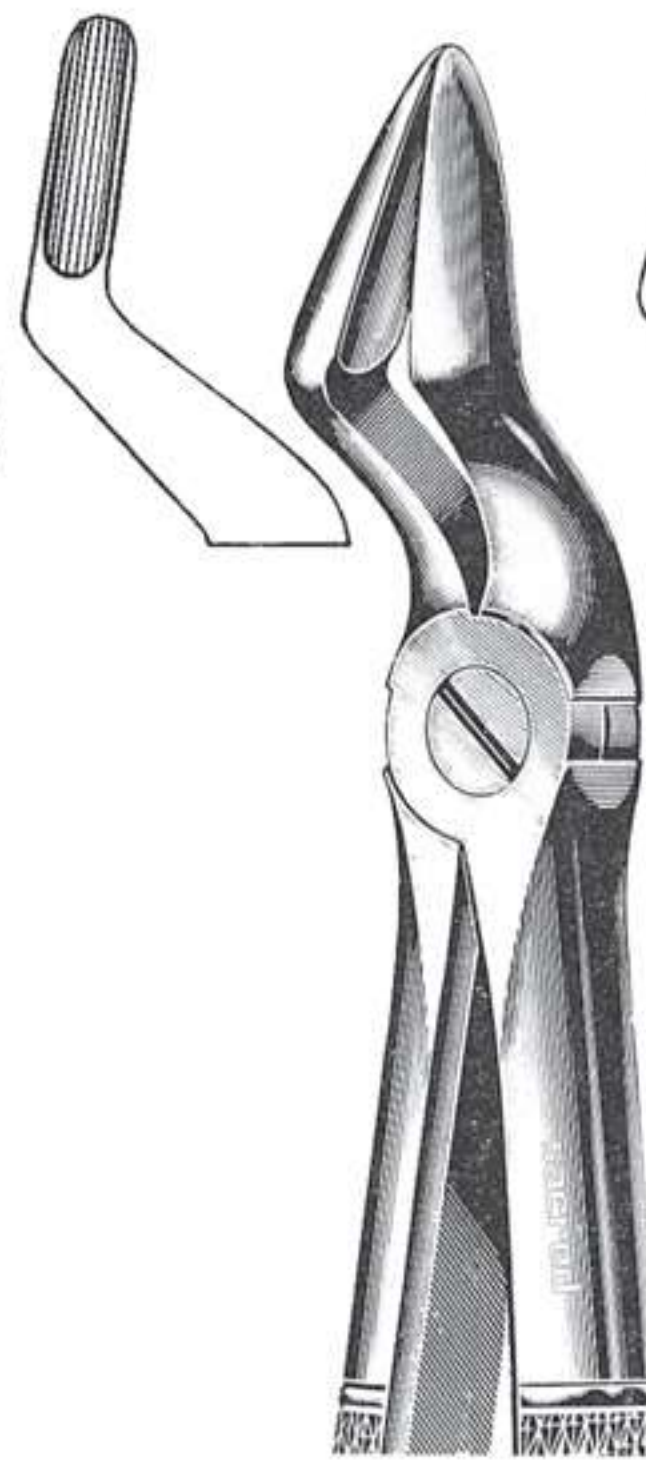

050-032  
Fig.52  
Upper roots & canines  
with wider beak

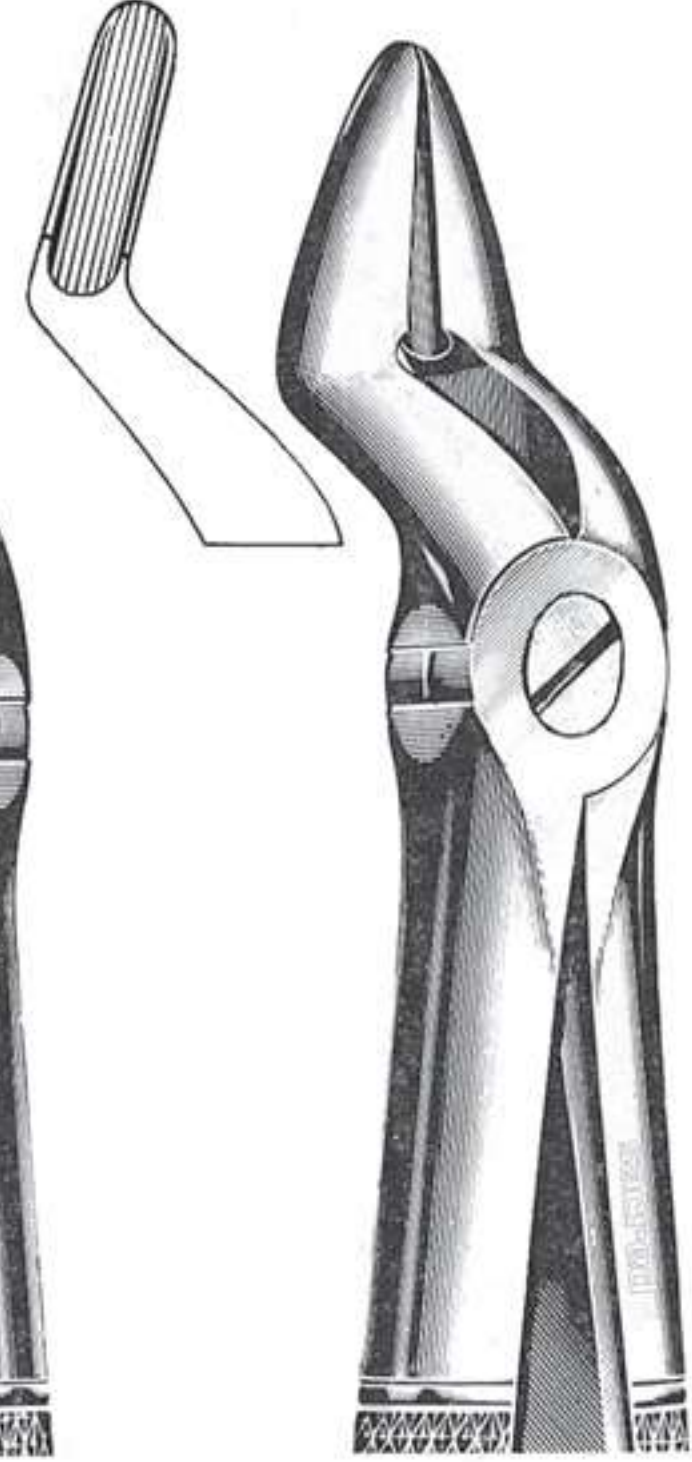

050-033  
Fig.52A  
Upper teeth &  
resection

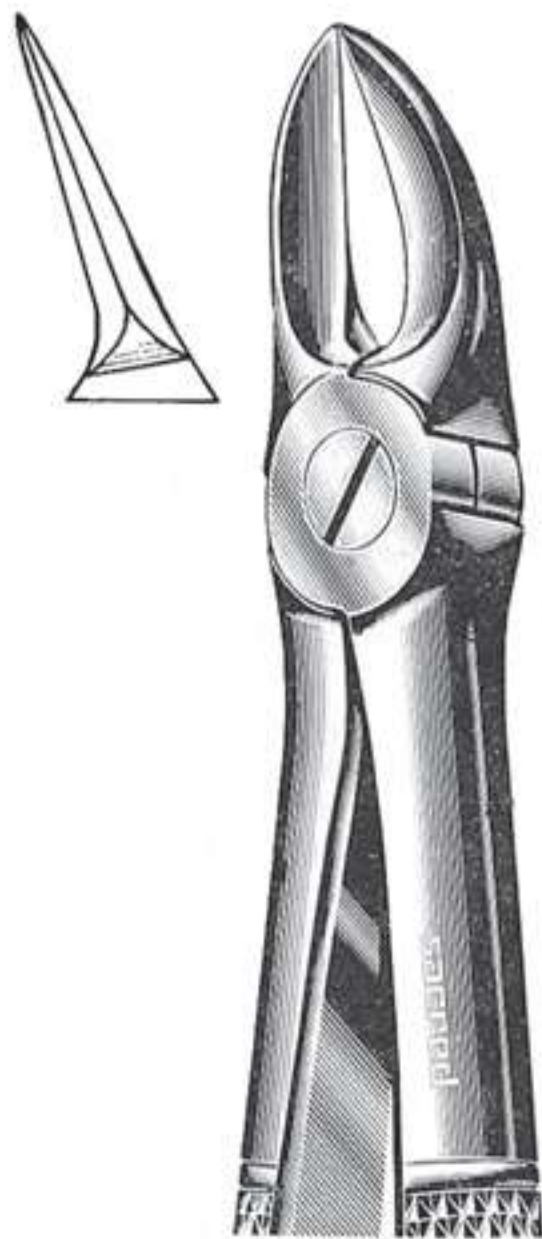

050-034  
Fig.55  
Separating upper  
molars roots

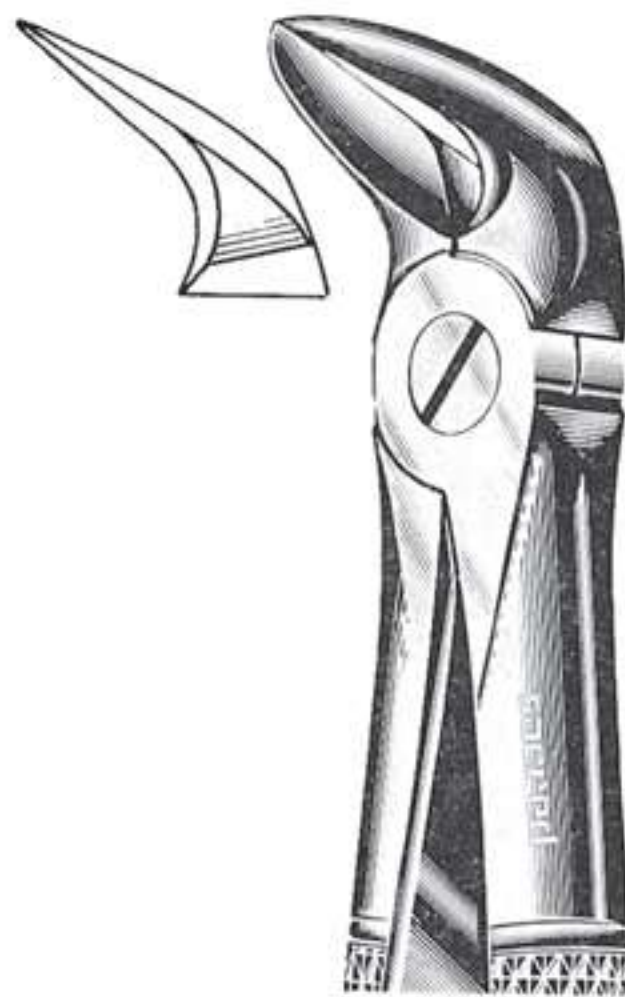

050-035  
Fig.56  
Separating lower  
molars roots

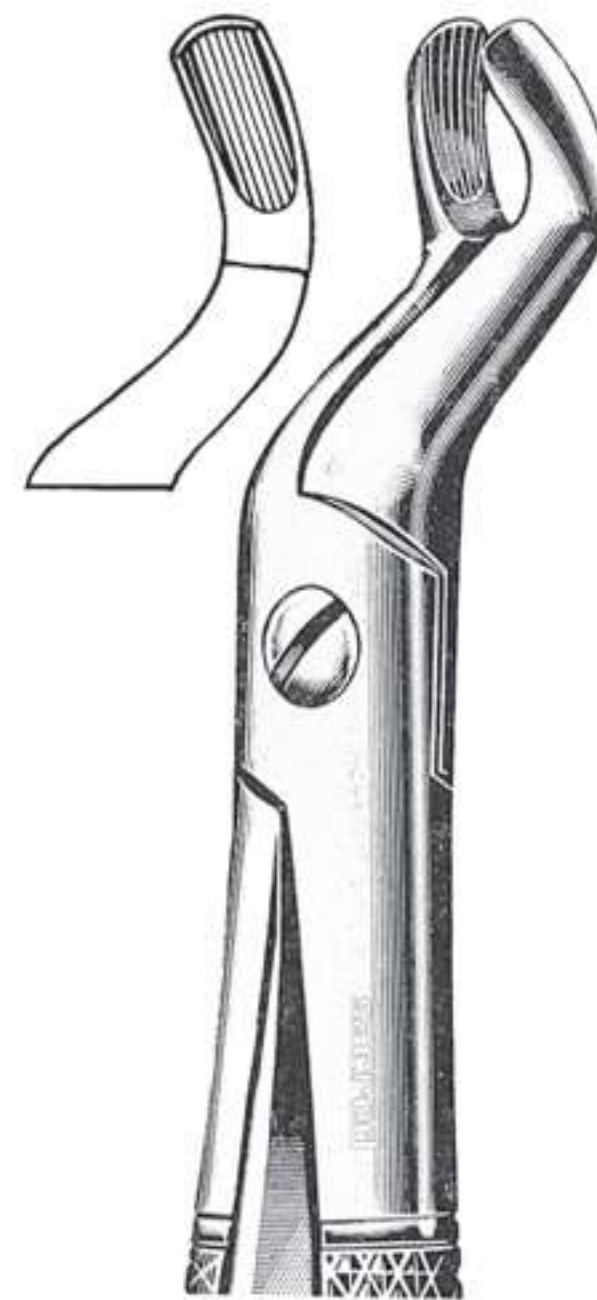

050-036  
Fig.67  
Upper wisdoms

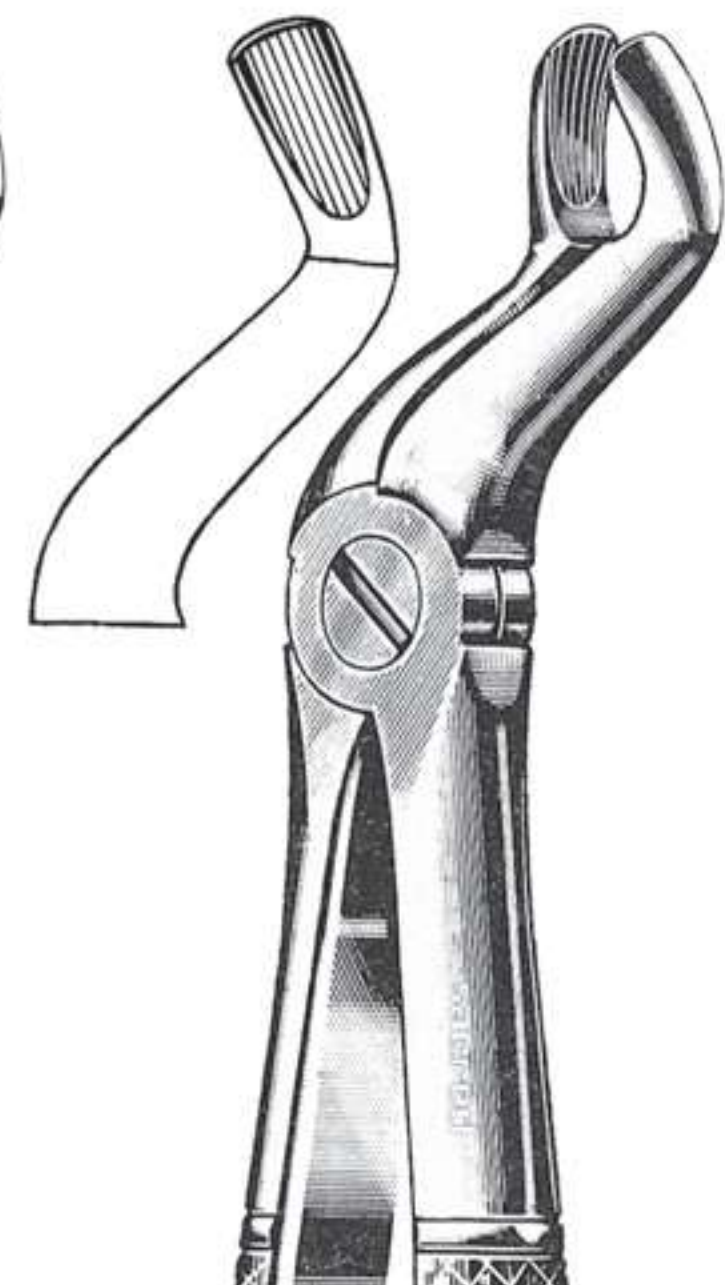

050-037  
Fig.67A  
Upper wisdoms



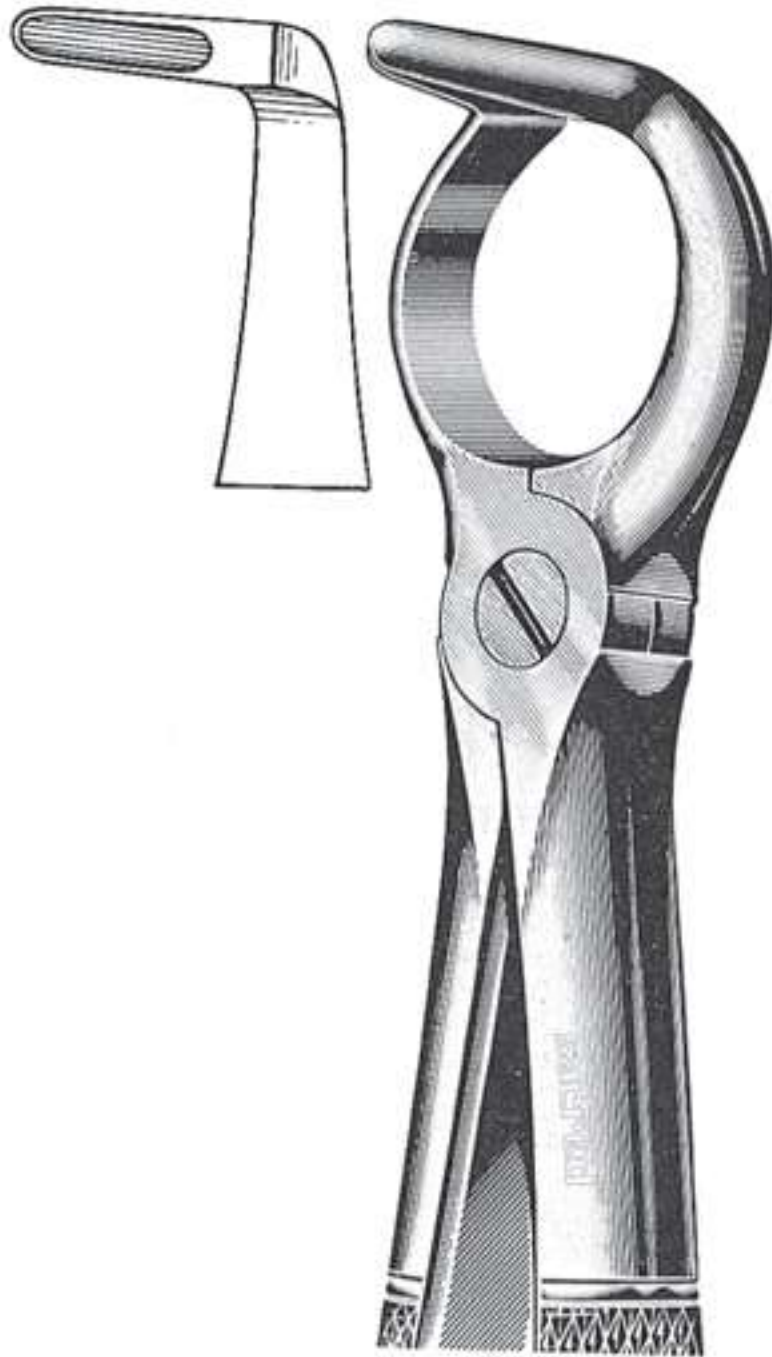

050-038  
Fig.68  
Lower roots

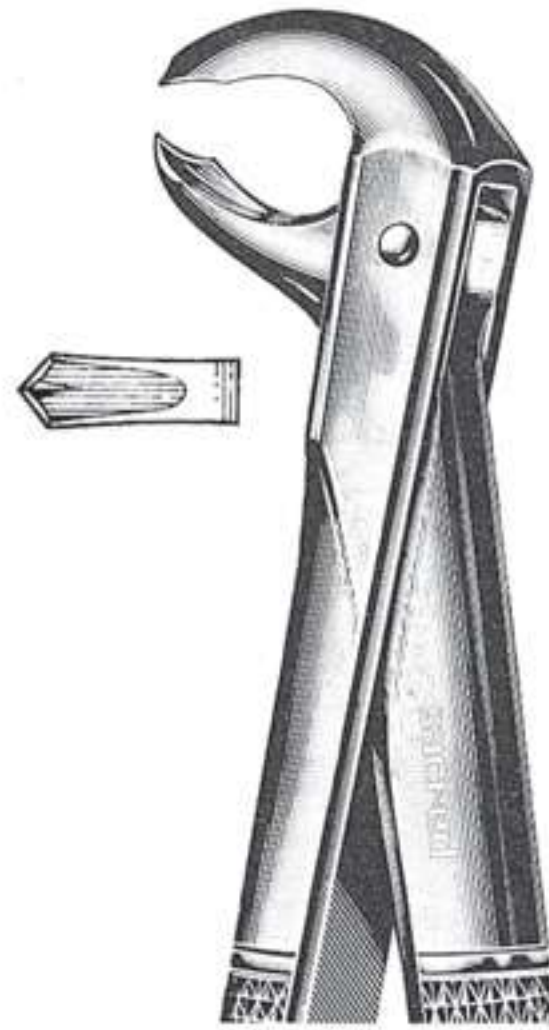

050-039  
Fig.73  
Lower molars  
(Hawk's bill)

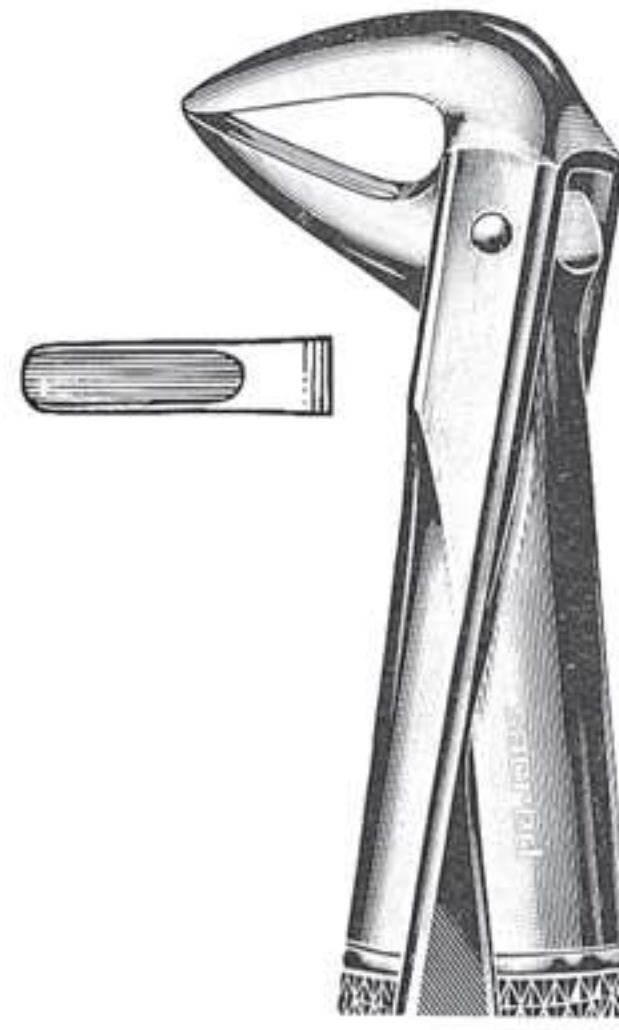

050-040  
Fig.74  
Lower incisors  
& roots



050-041  
Fig.74M  
Lower incisors  
& roots

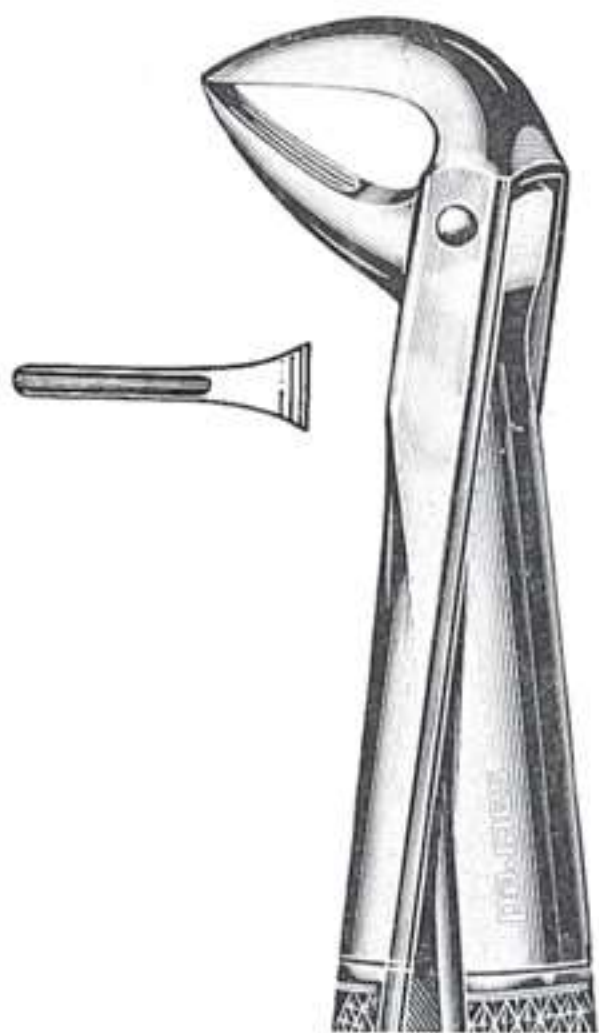

050-042  
Fig.74N  
Lower incisors  
& roots

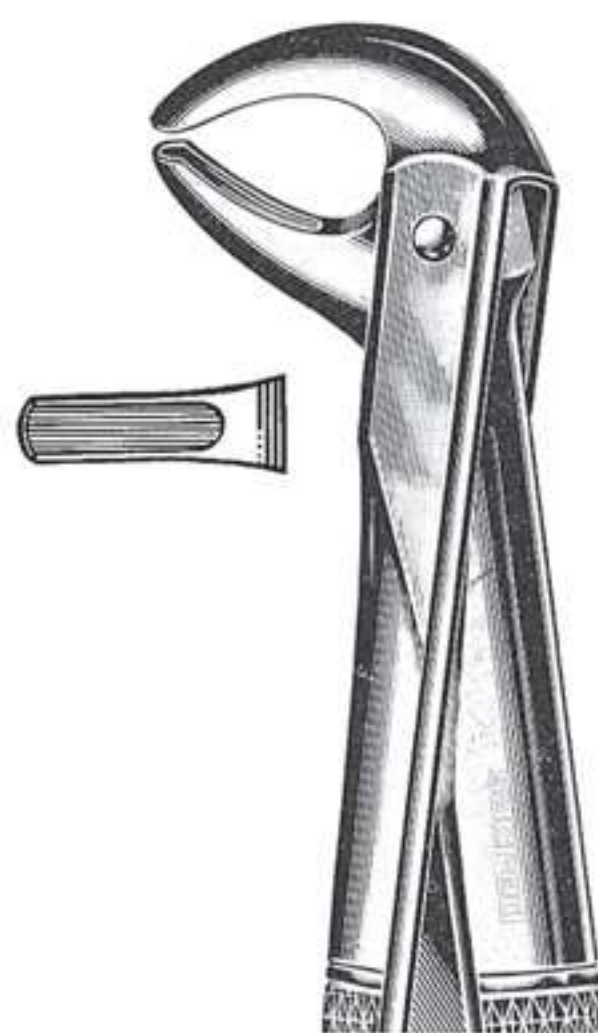

050-043  
Fig.75  
Lower premolars  
& canines



050-044  
Fig.76  
Upper roots

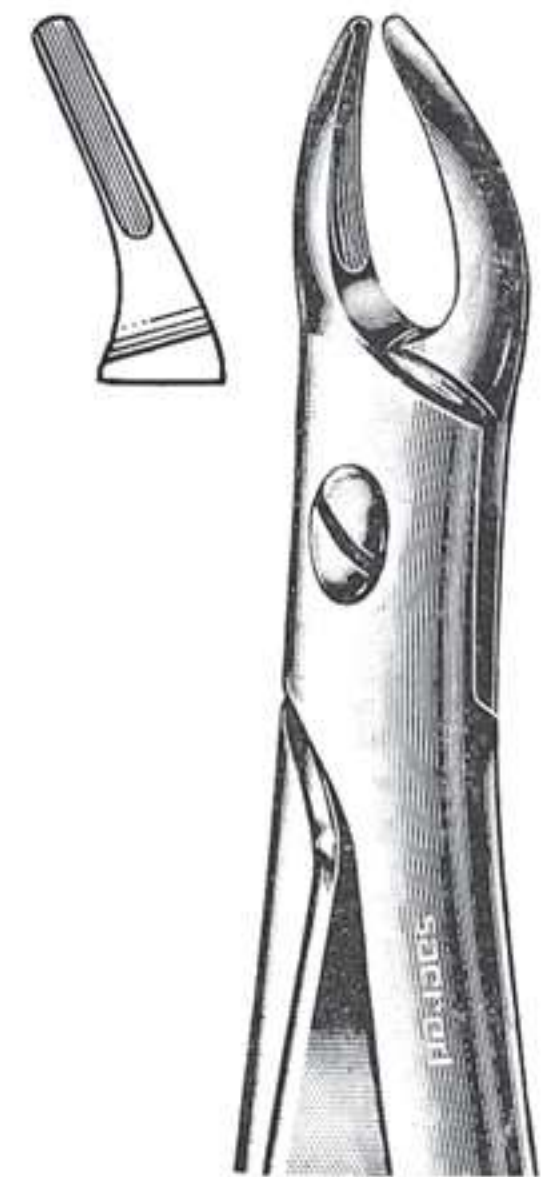

050-045  
Fig.76N  
Upper roots  
(narrow beak)



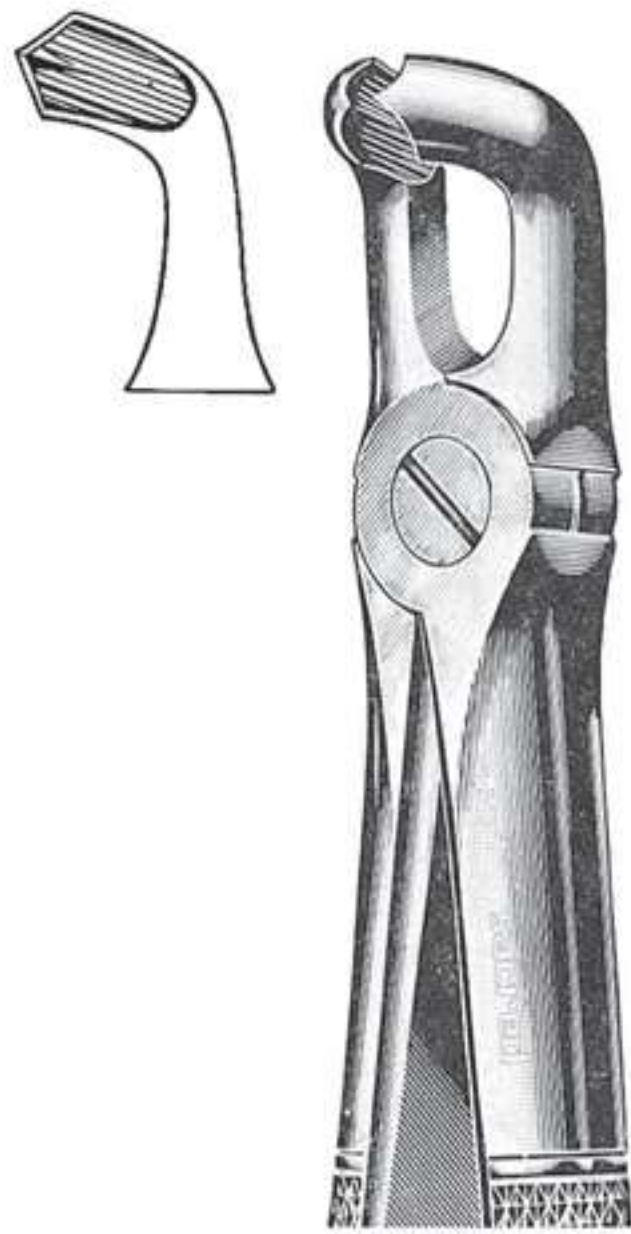

050-046  
Fig.79  
Lower wisdoms

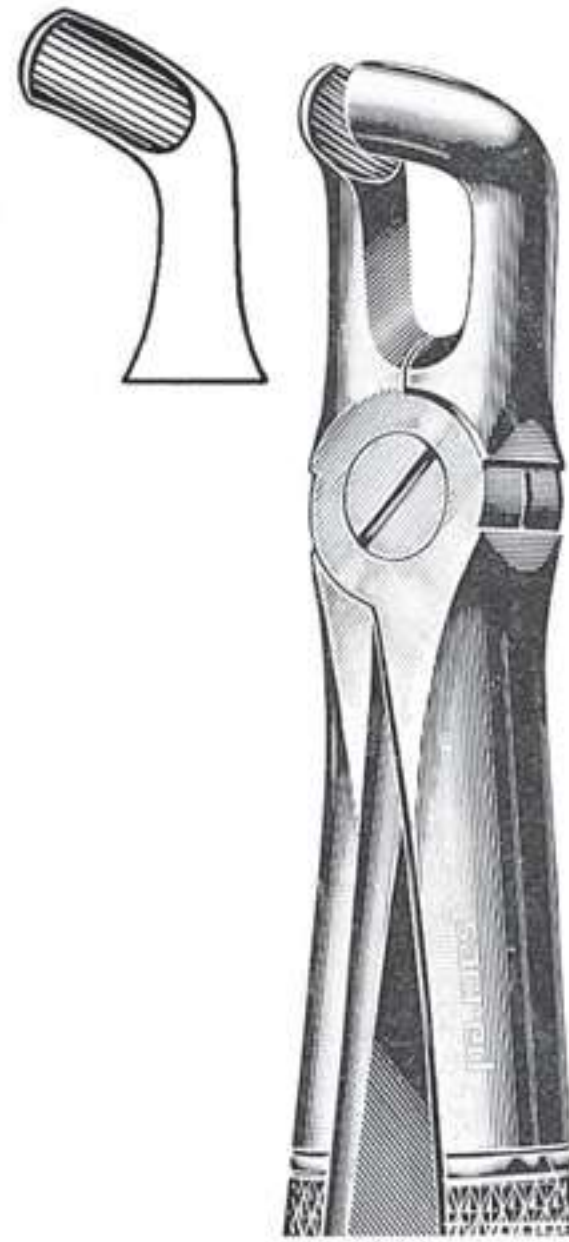

050-047  
Fig.79A  
Lower wisdoms



050-048  
Fig.86A  
Lower molars



050-049  
Fig.86B  
Lower molars



050-050  
Fig.86C  
Lower molars

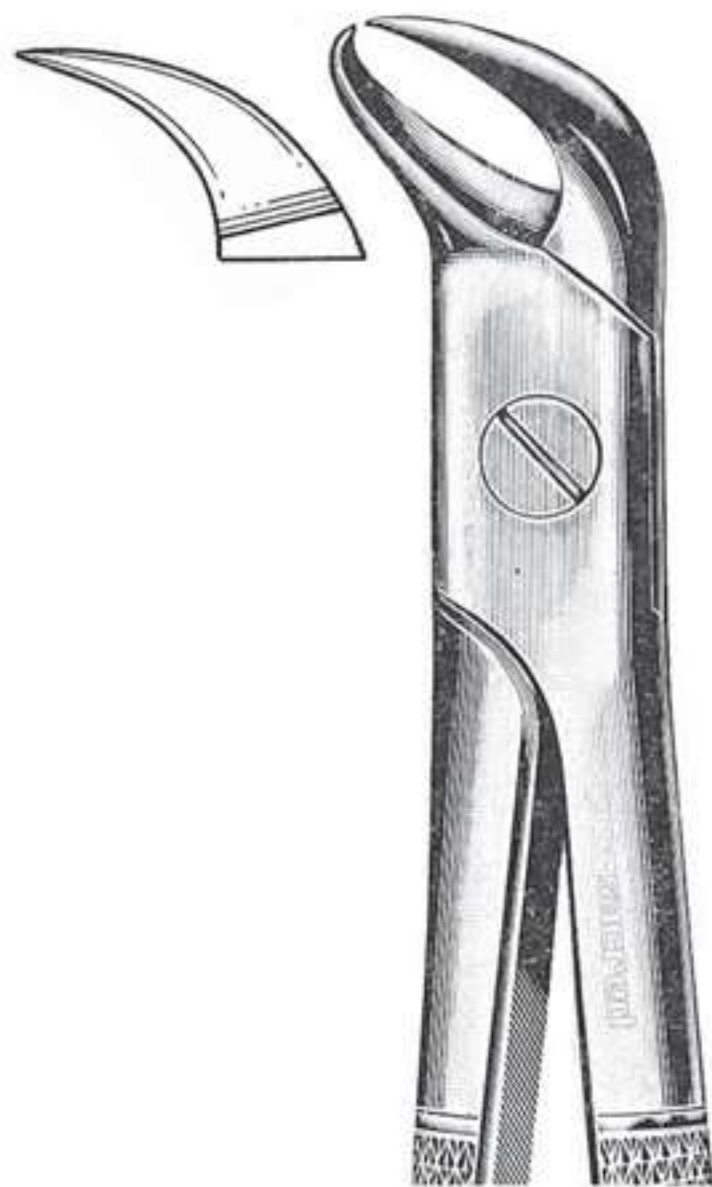

050-051  
Fig.87  
Cowhorn beak

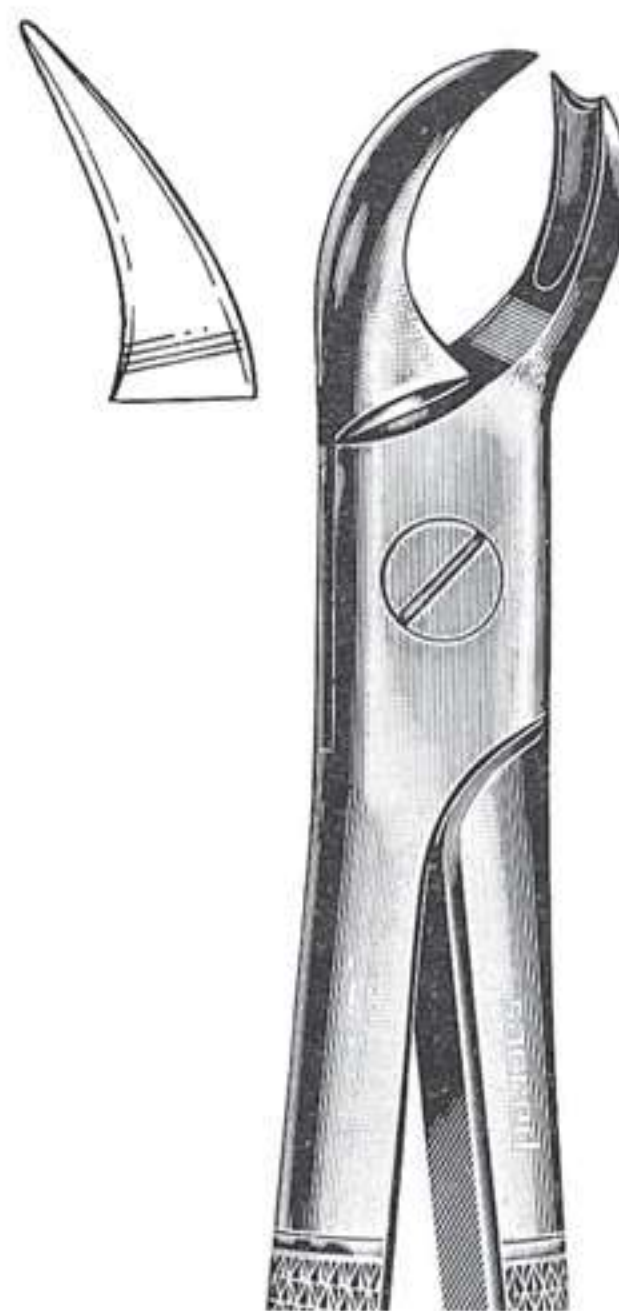

050-052  
Fig.89  
Right upper molars

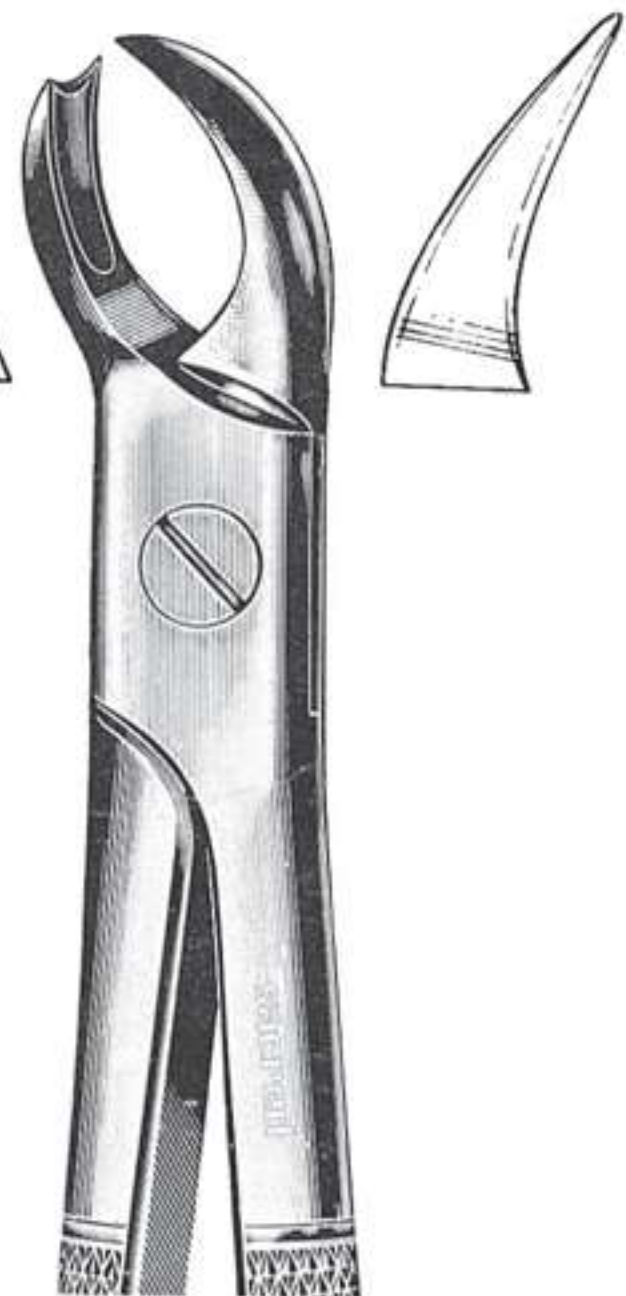
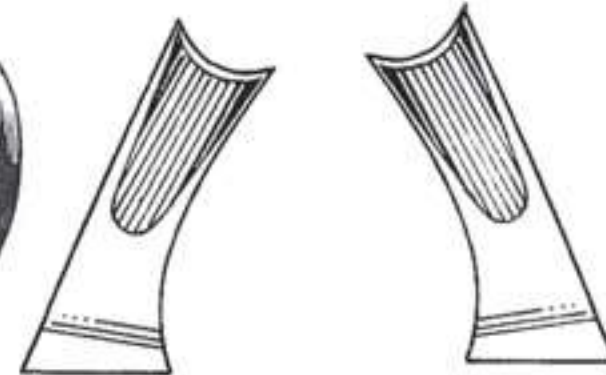

050-053  
Fig.90  
Left upper molars



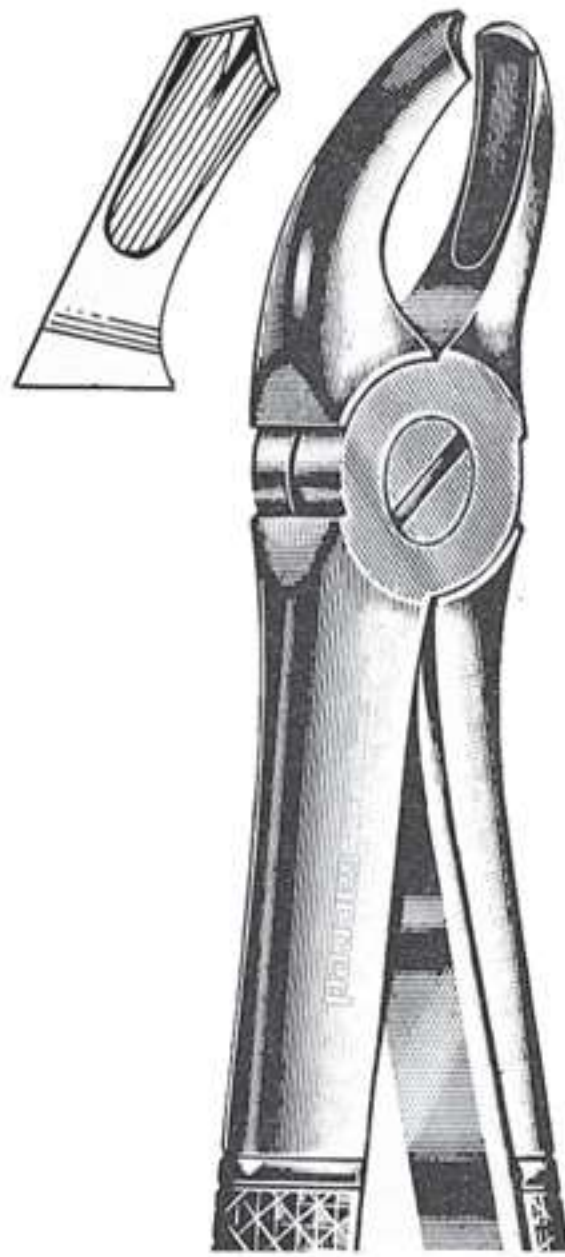

050-054  
Fig.94  
Right upper molars

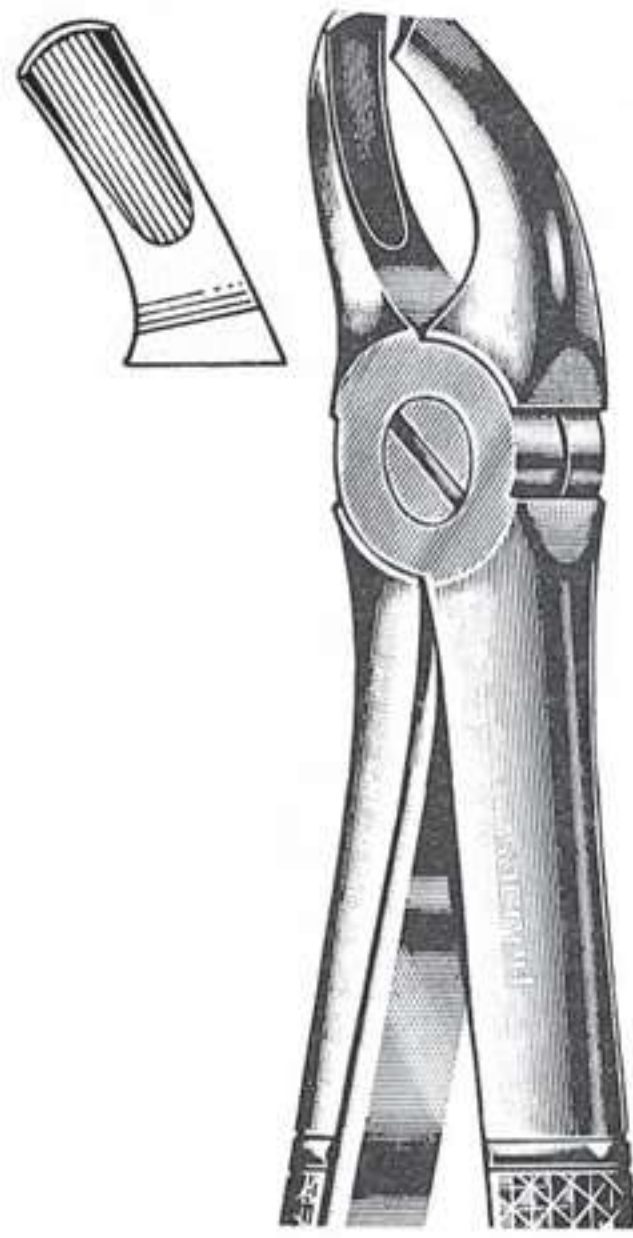

050-055  
Fig.95  
Left upper molars

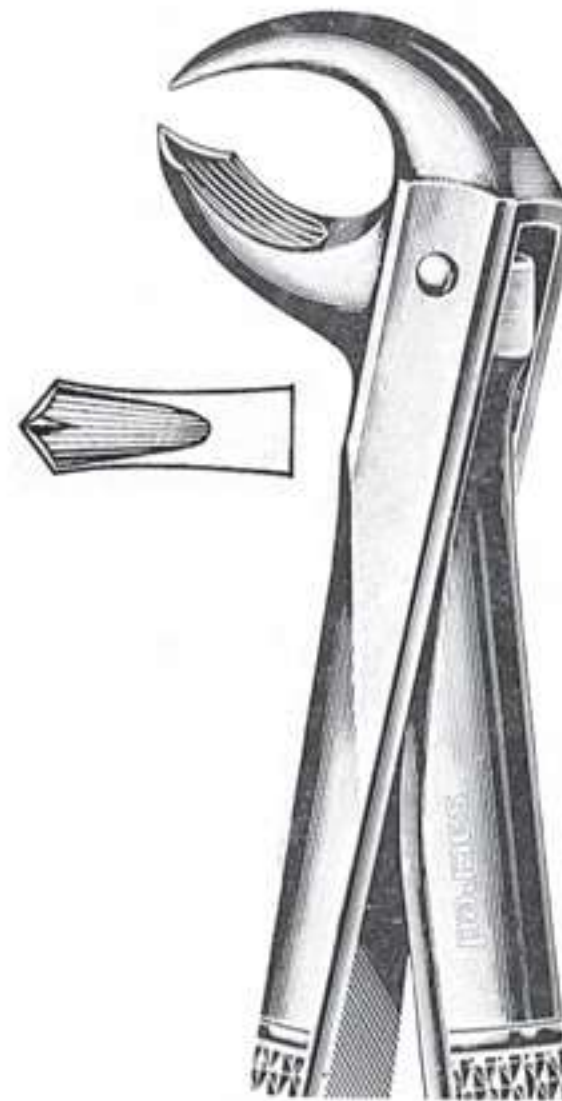

050-056  
Fig.99  
Lower molars  
(broken-down)



050-057  
Fig.99 1/4  
Lower molars  
(broken-down)

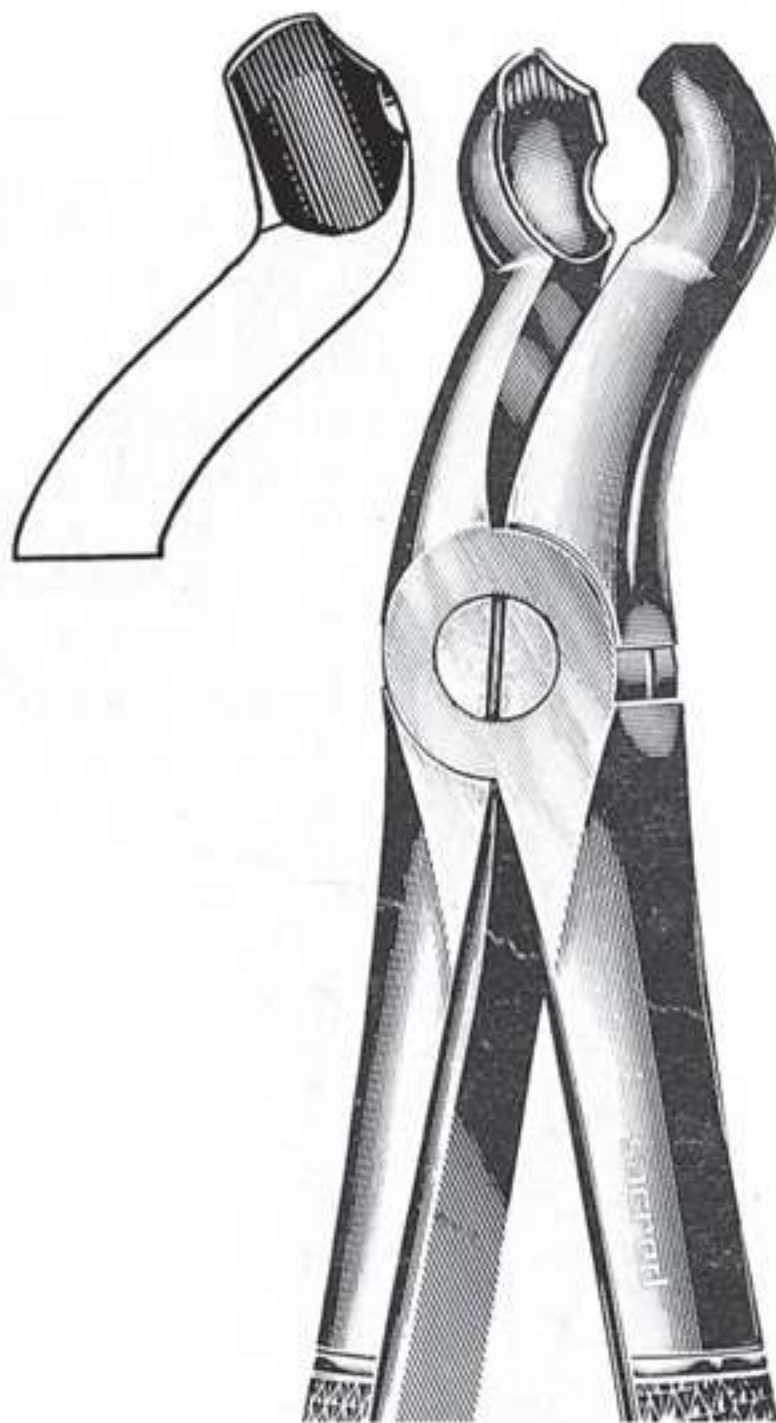

050-058  
Fig.121  
Upper wisdoms

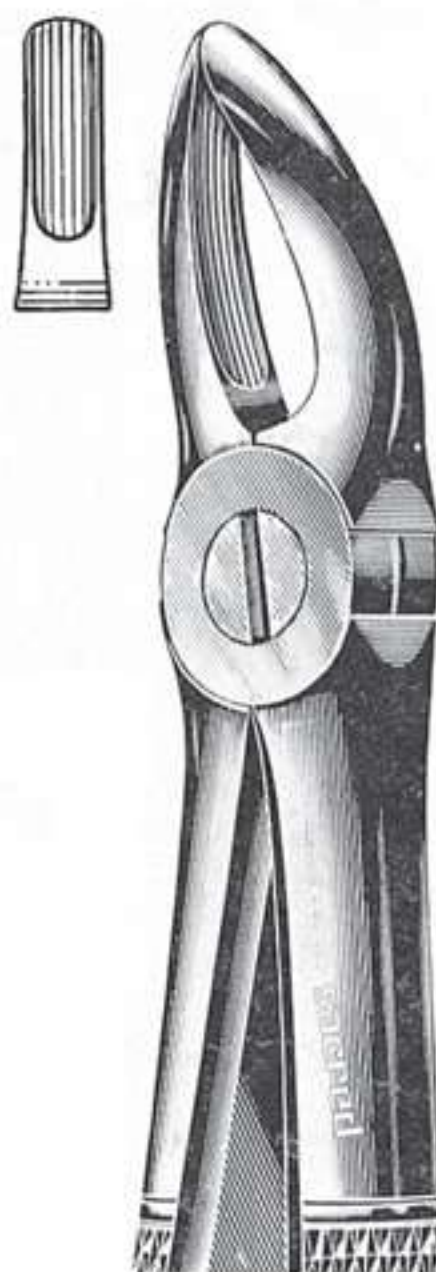

050-059  
Fig.136  
Upper centrals  
& roots

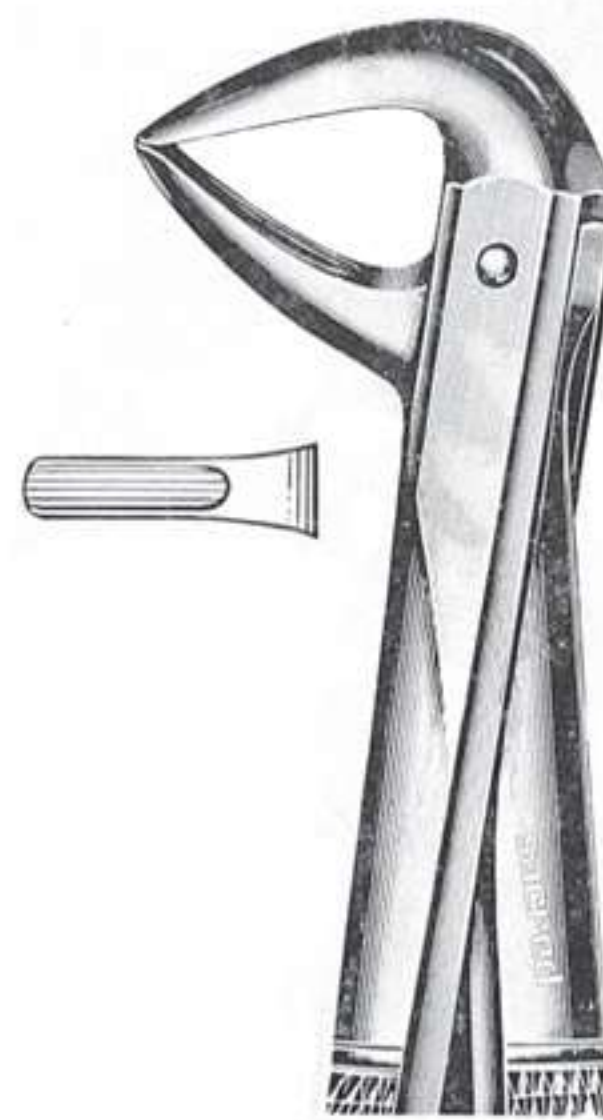

050-060  
Fig.137  
Lower centrals  
& roots

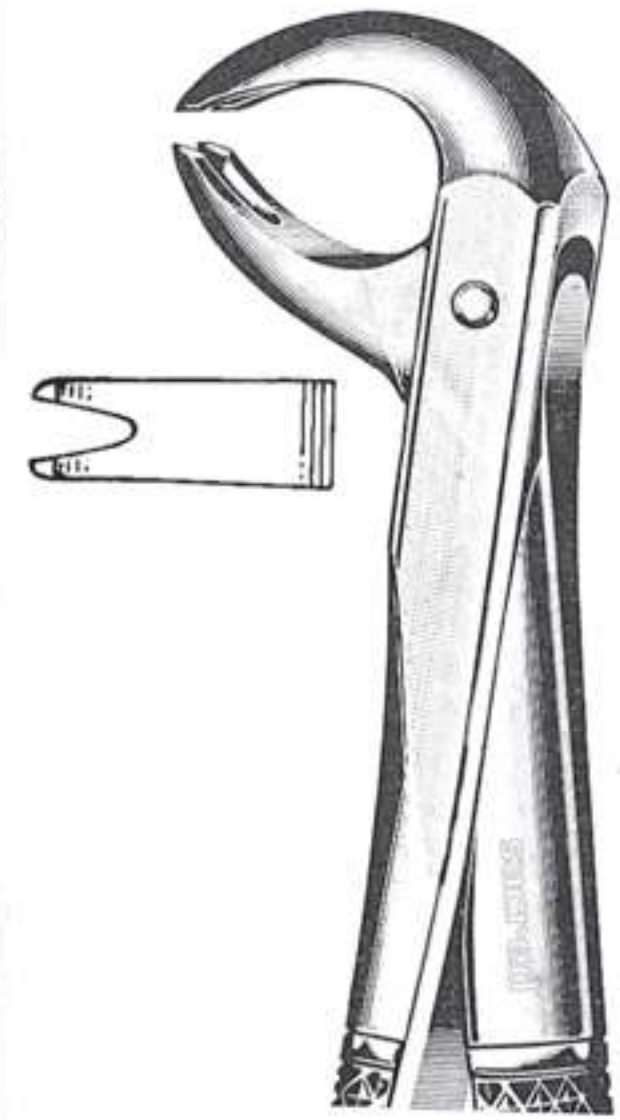

050-061  
Fig.167  
Universal pincer  
for lower teeth  
molars & premolars



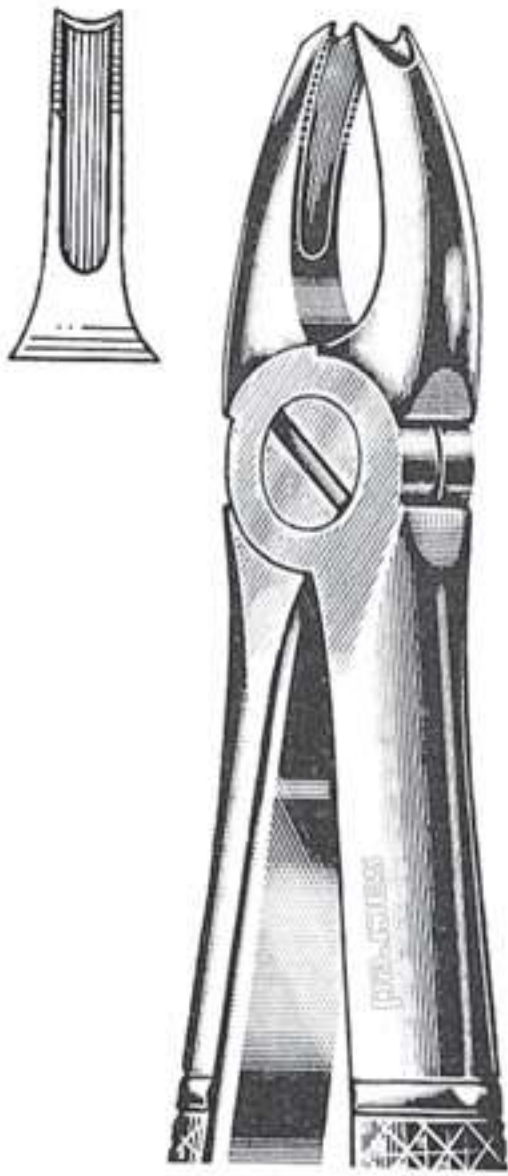

050-062  
Fig.168  
Upper canines

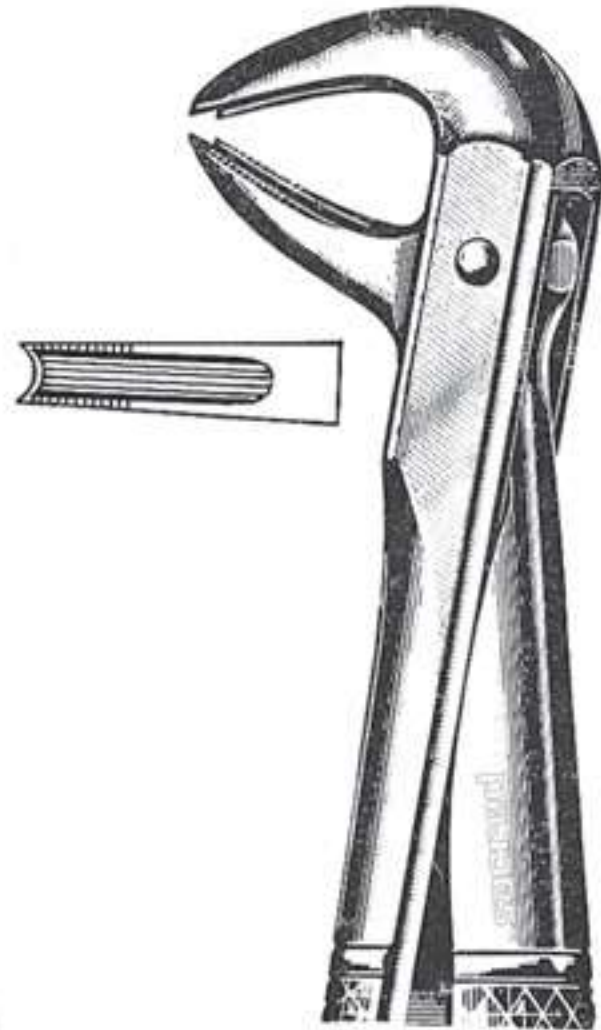

050-063  
Fig.169  
Lower canines  
& premolars

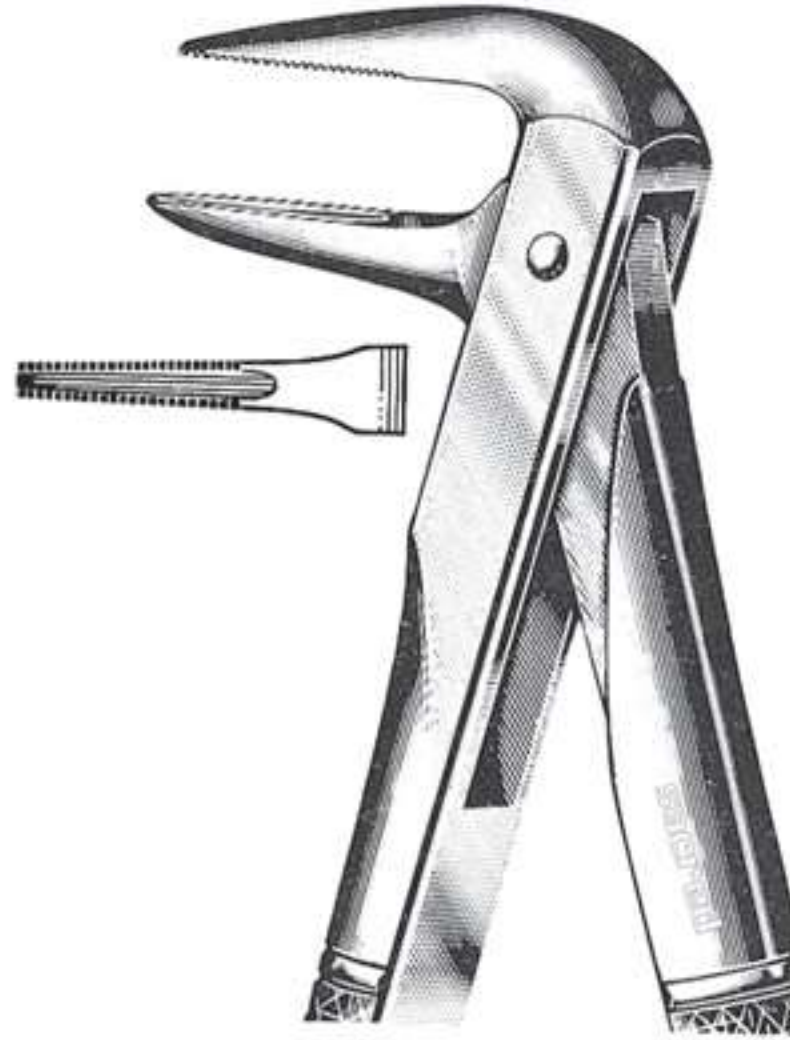

050-064  
Fig.233  
Lower roots  
(parallel beaks)



050-065  
Fig.235  
Upper roots  
(parallel beaks)

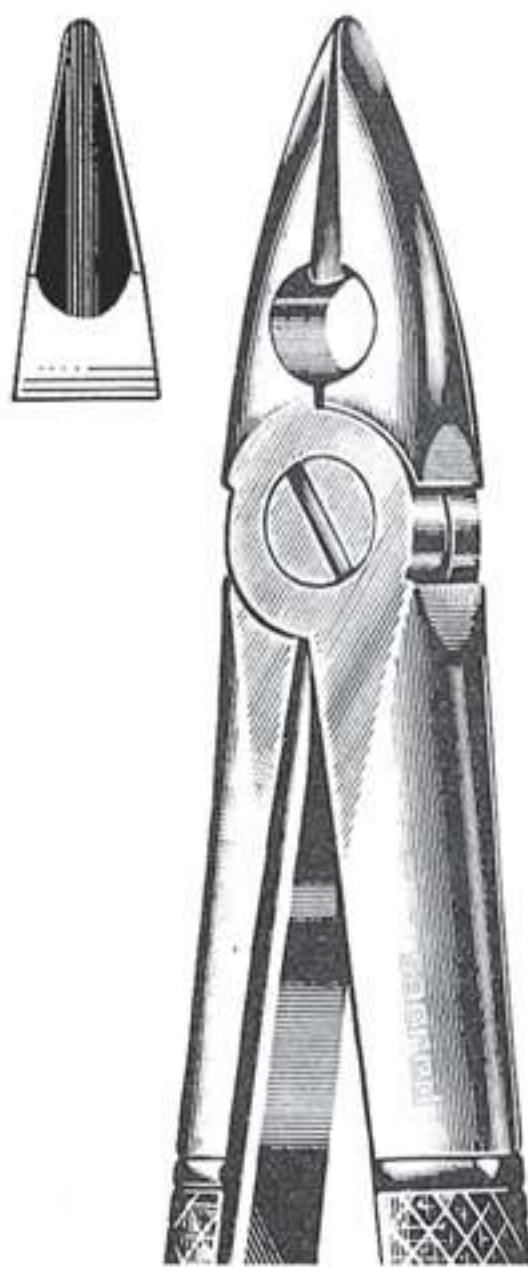

050-066  
Fig. MD 1  
Universal forceps for upper  
wisdoms, premolars & roots

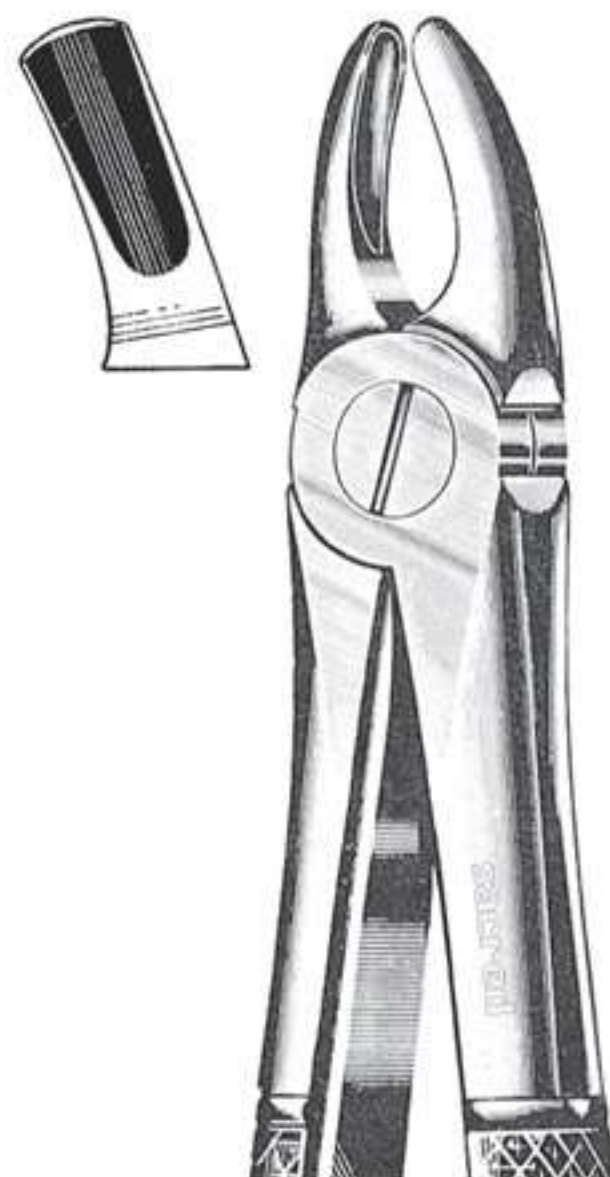

050-067  
Fig. MD 2  
Upper molars

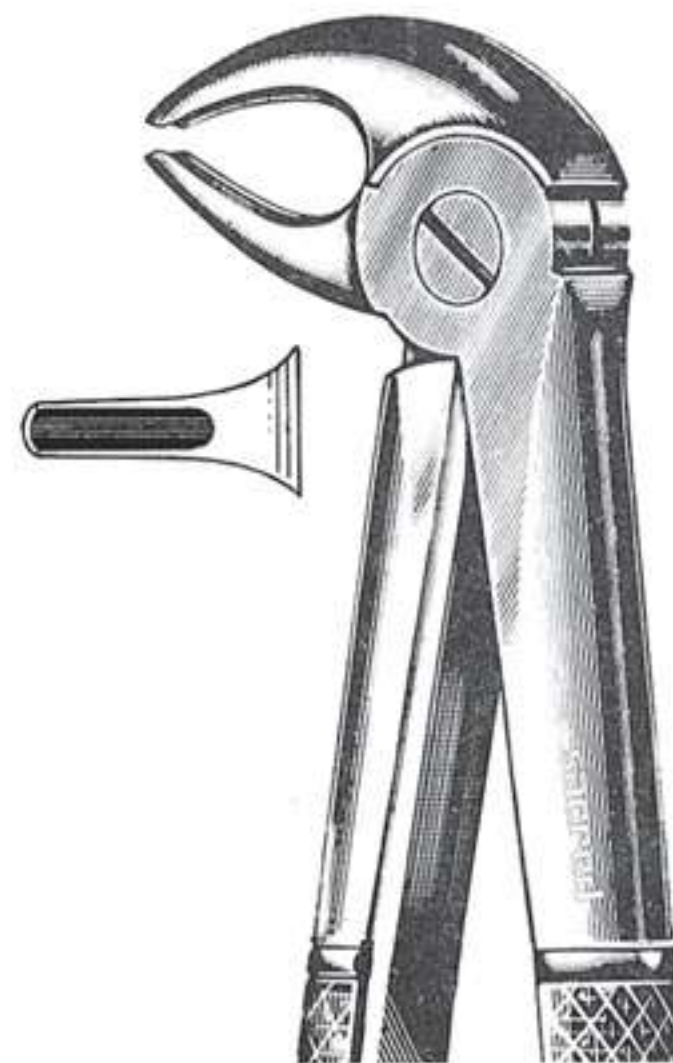

050-068  
Fig. MD 3  
lower incisors, premolars  
& roots

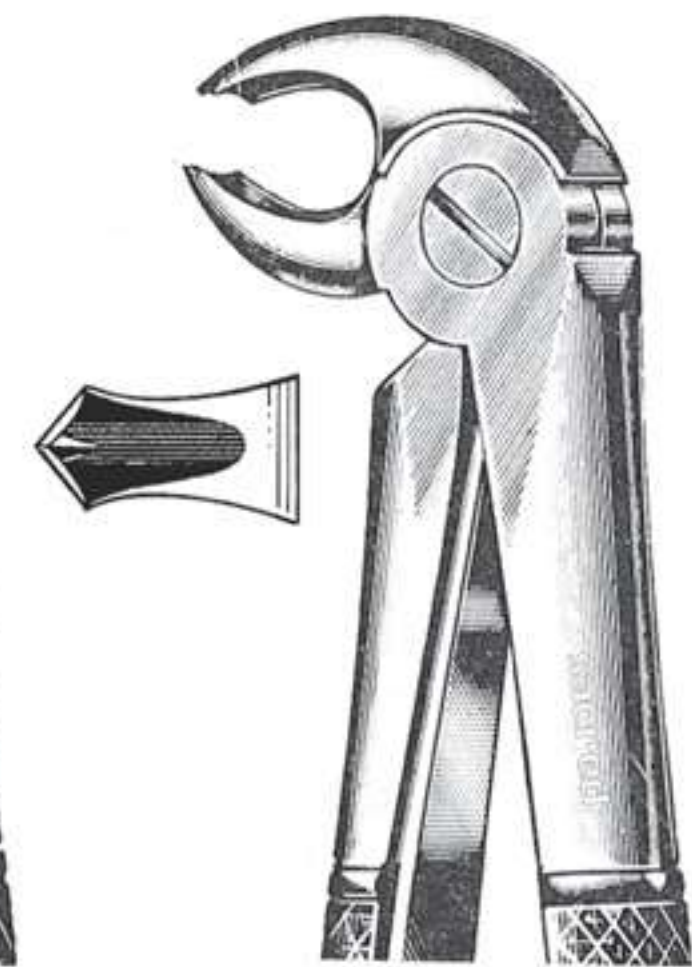

050-069  
Fig. MD 4  
Lowers molars



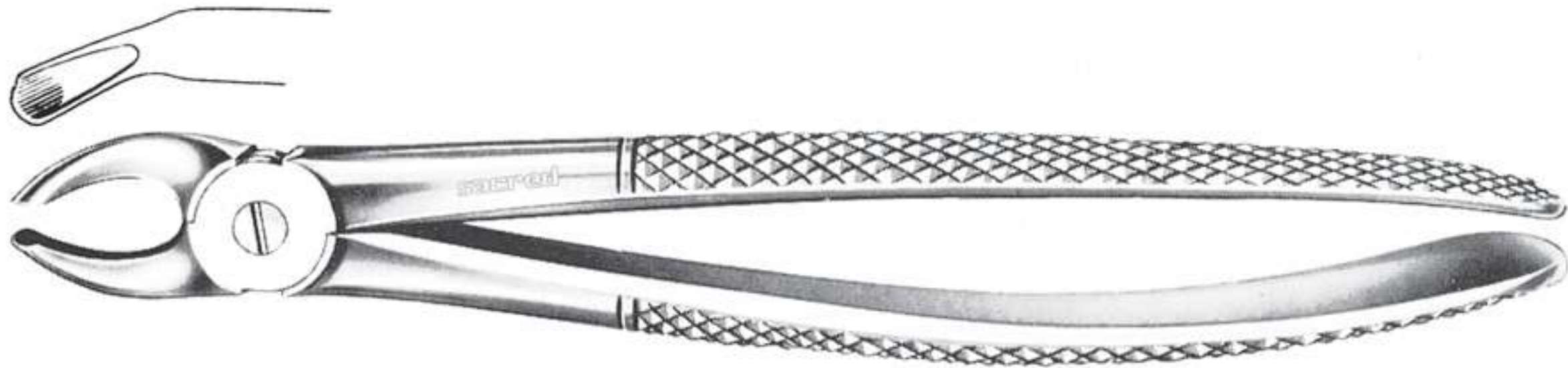

050-070  
Fig. 158  
Children's upper molars universal



050-071  
Fig. 159  
Children's upper teeth universal



050-072  
Fig. 160  
Children's lower molars universal(hawk's bill)



050-073  
Fig. 161  
Children's lower centrals & roots

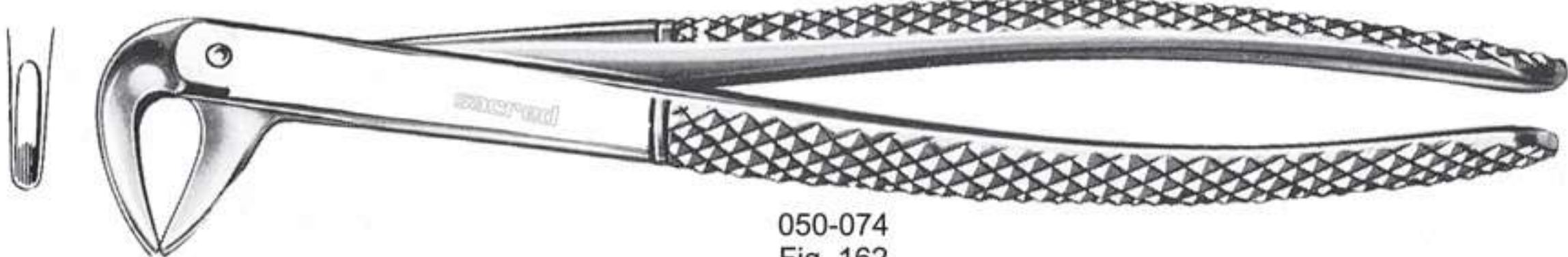

050-074  
Fig. 162  
Children's upper centrals



050-075  
Fig. 163  
Children's upper centrals



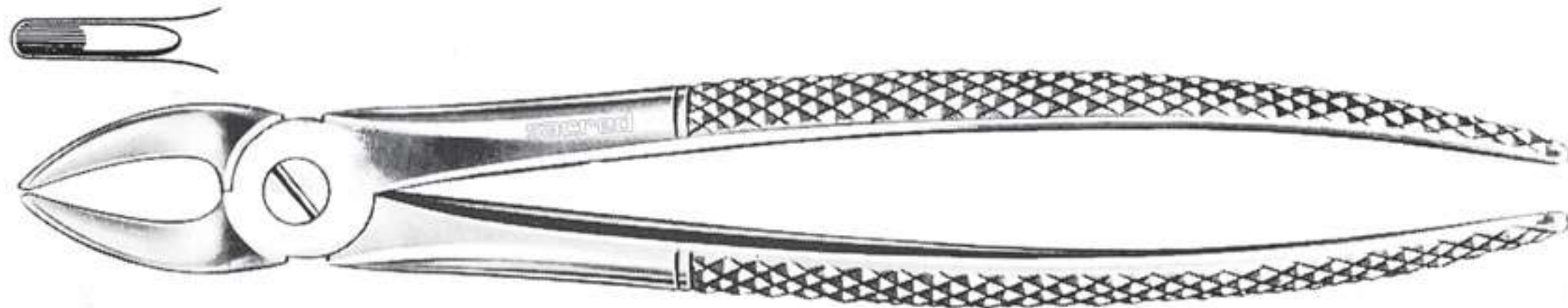

050-076  
Fig. 37  
Children's upper incisors & canines

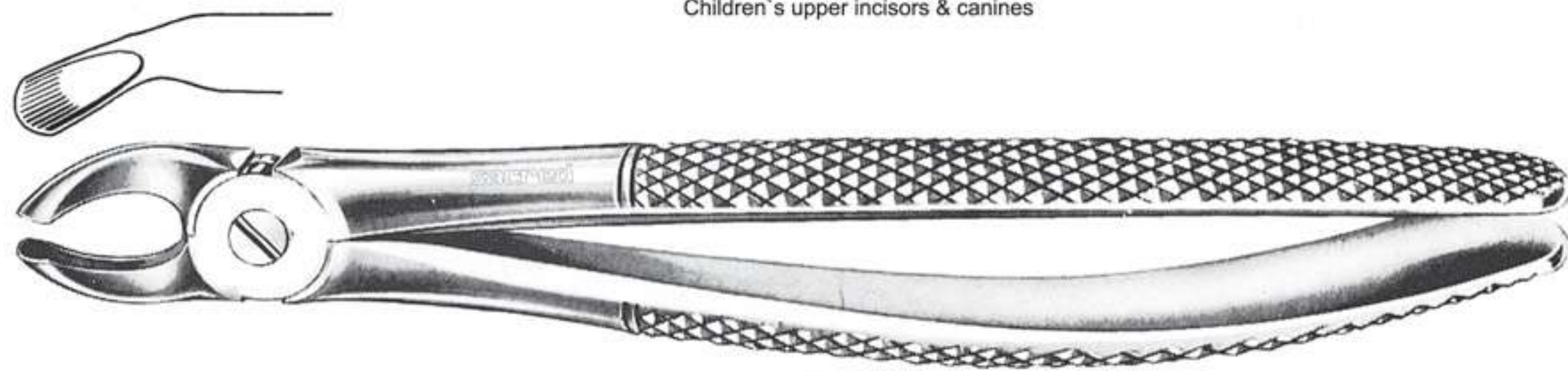

050-077  
Fig. 39  
Children's upper molars universal

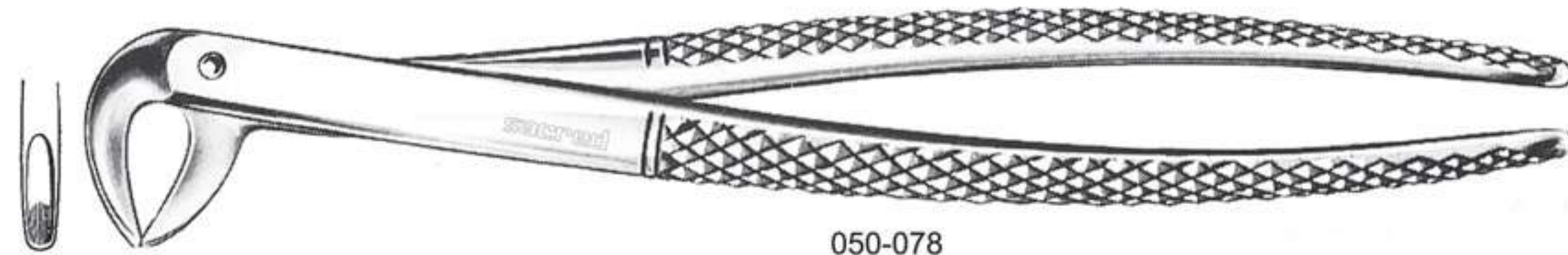

050-078  
Fig. 123  
Children's lower teeth universal

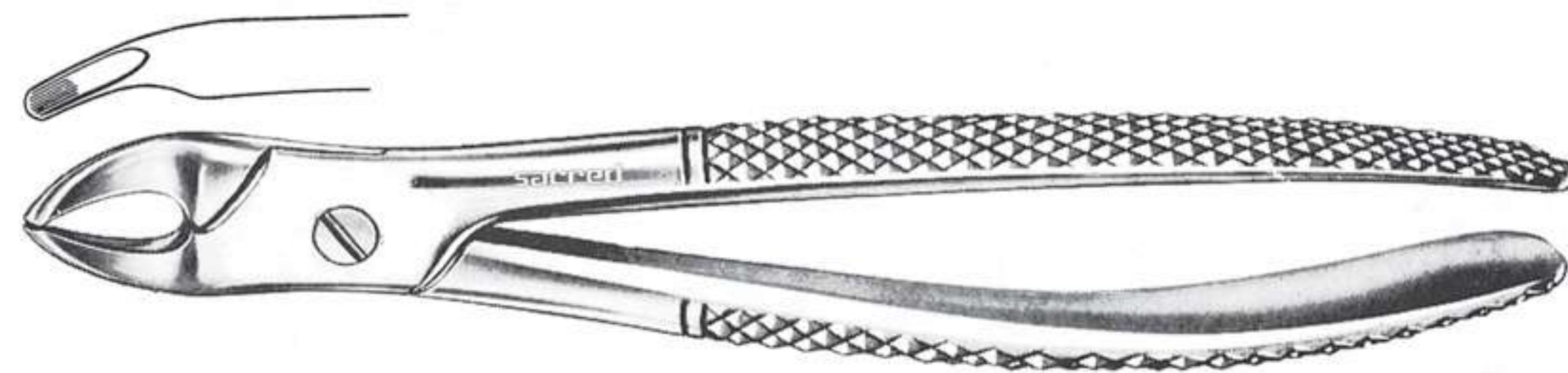

050-079  
Fig. 138  
Children's upper universal & roots

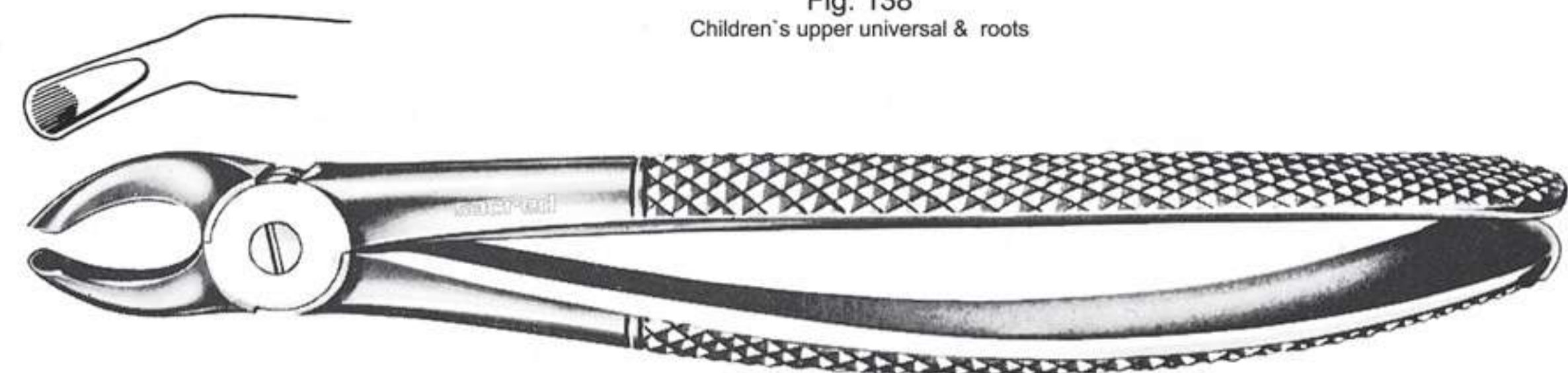

050-080  
Fig. 157  
Children's upper molars universal





050-081  
universal pattern for upper teeth



050-082  
universal pattern for lower teeth

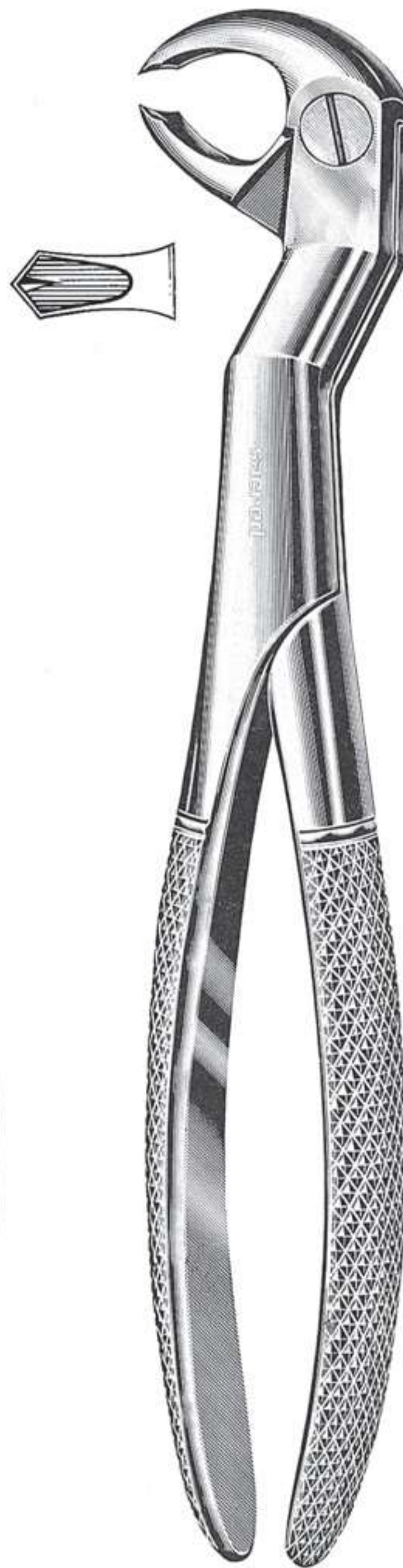

050-083  
Fig. 22 1/2L  
Left lower wisdoms  
& molars



050-084  
Fig. 22 1/2 R  
Right lower wisdoms  
& molars



Extracting Forceps  
Set of 7  
050-8591S



050-085  
Fig. 3  
Upper molars

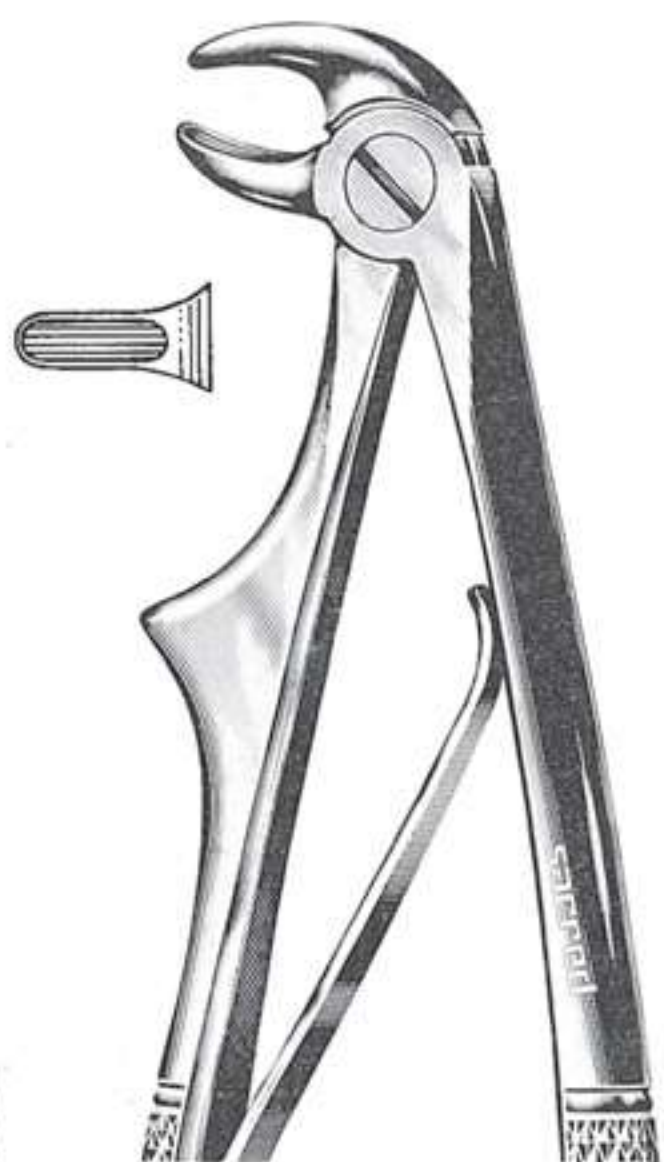

050-086  
Fig. 5  
Lower incisors

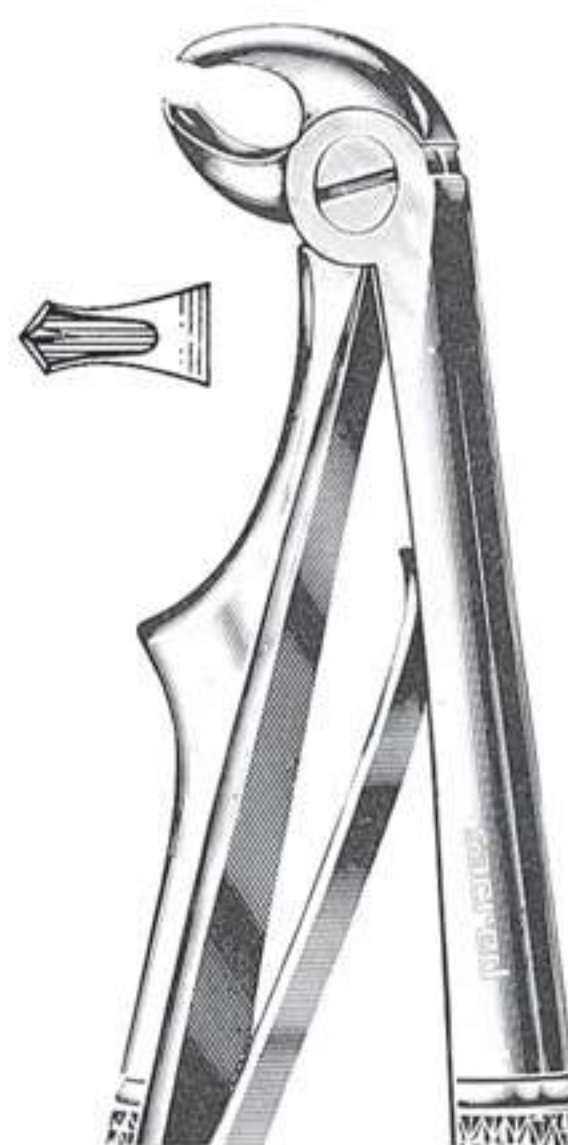

050-087  
Fig. 6  
Lower molars

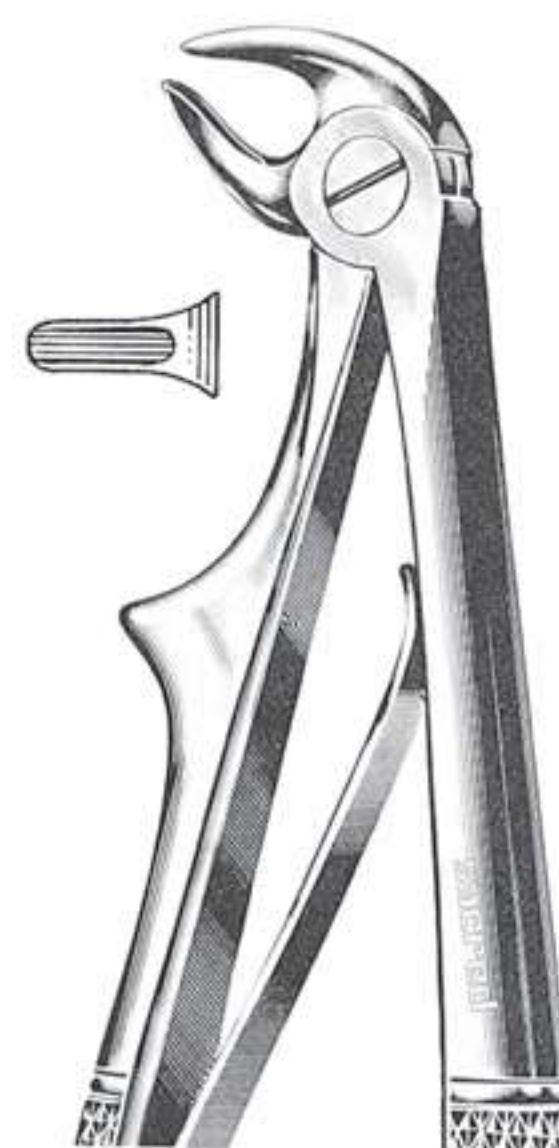

050-088  
Fig. 7  
Lower roots



050-089  
Fig. 137  
Upper incisors  
& canines



050-090  
Fig. 139  
Upper premolars

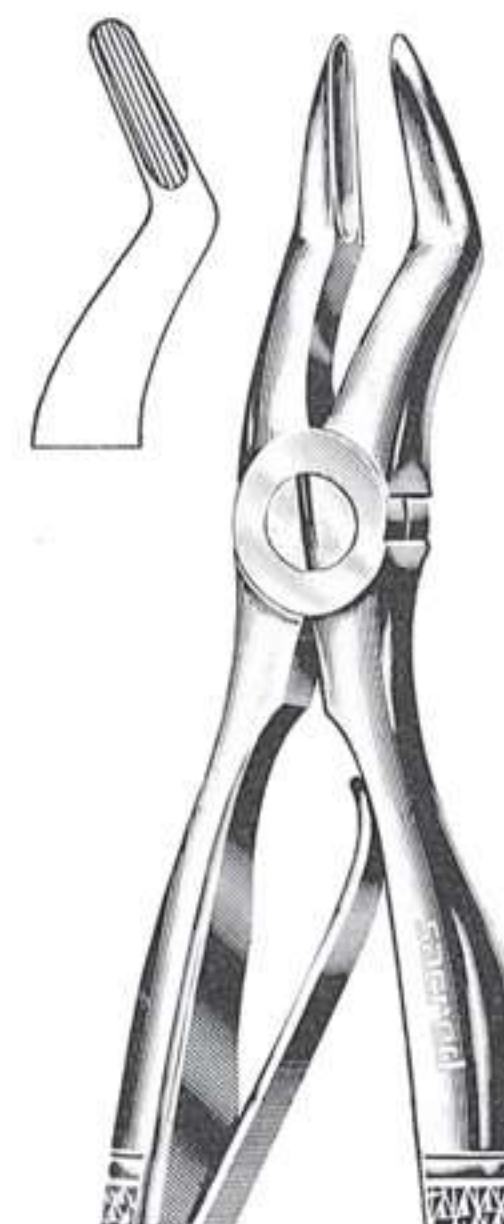

050-091  
Fig. 51S  
Upper roots



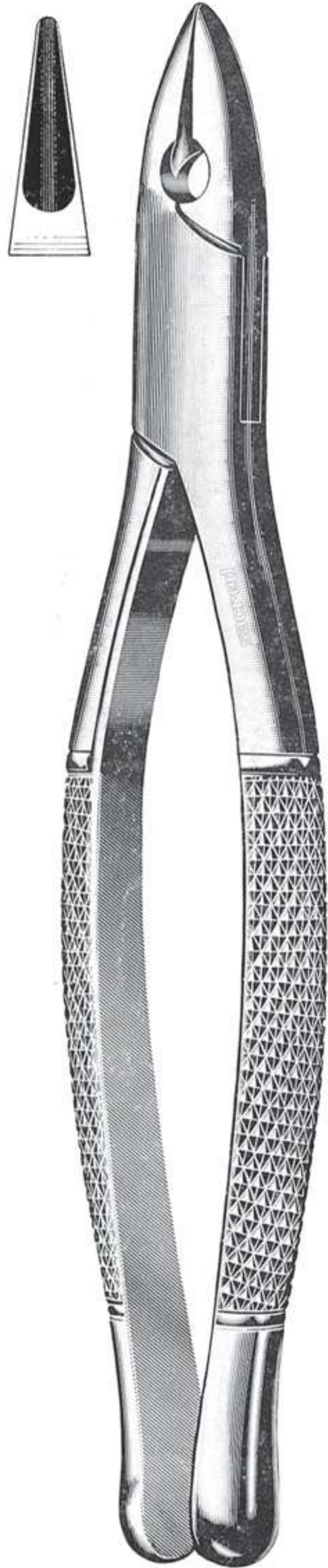

050-092  
Fig. 1  
Upper centrals, laterals & cuspids

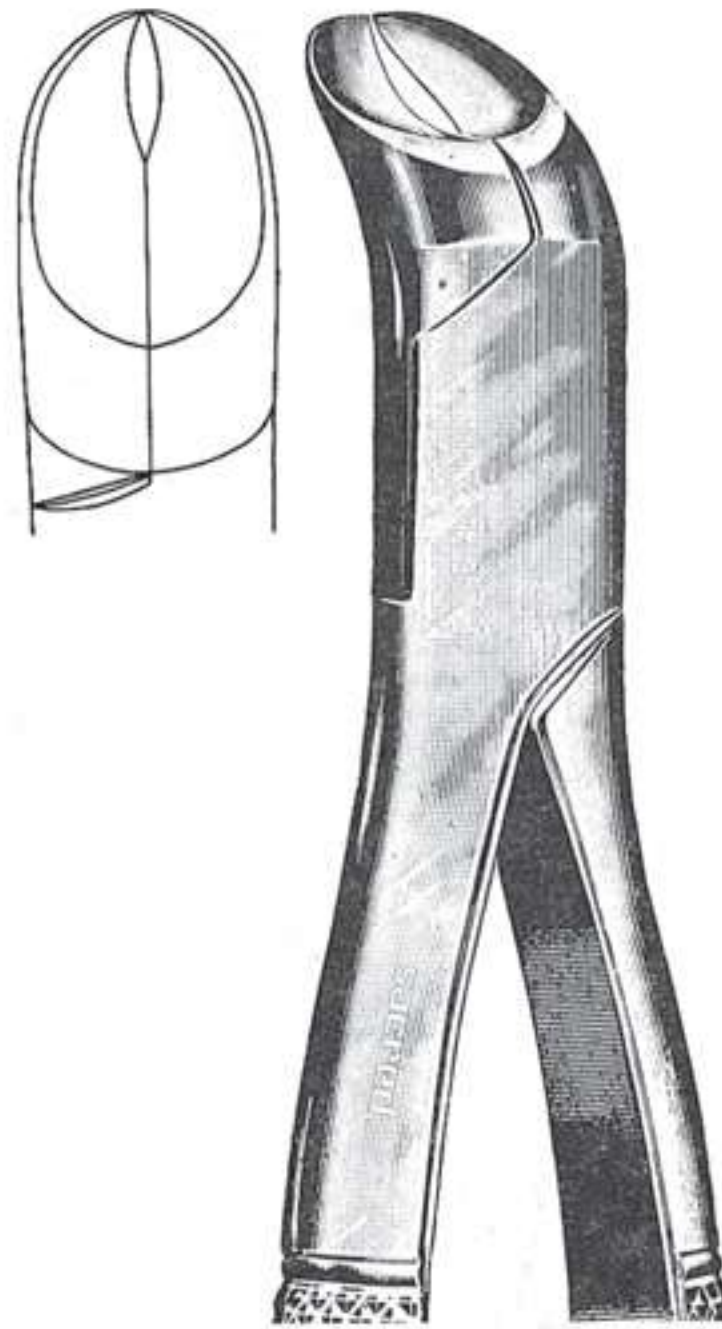

050-093  
Fig. 5  
Lower third molars

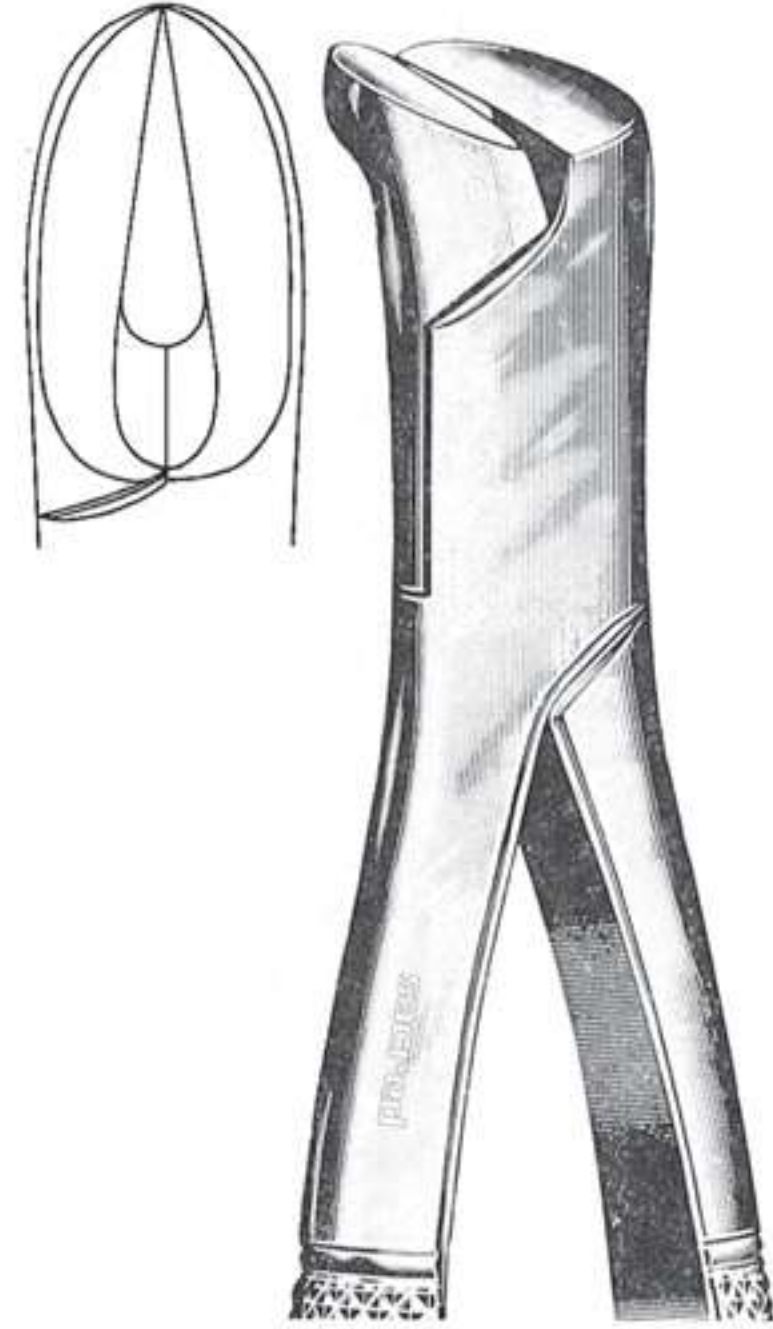

050-094  
Fig. 6  
Splitting forceps

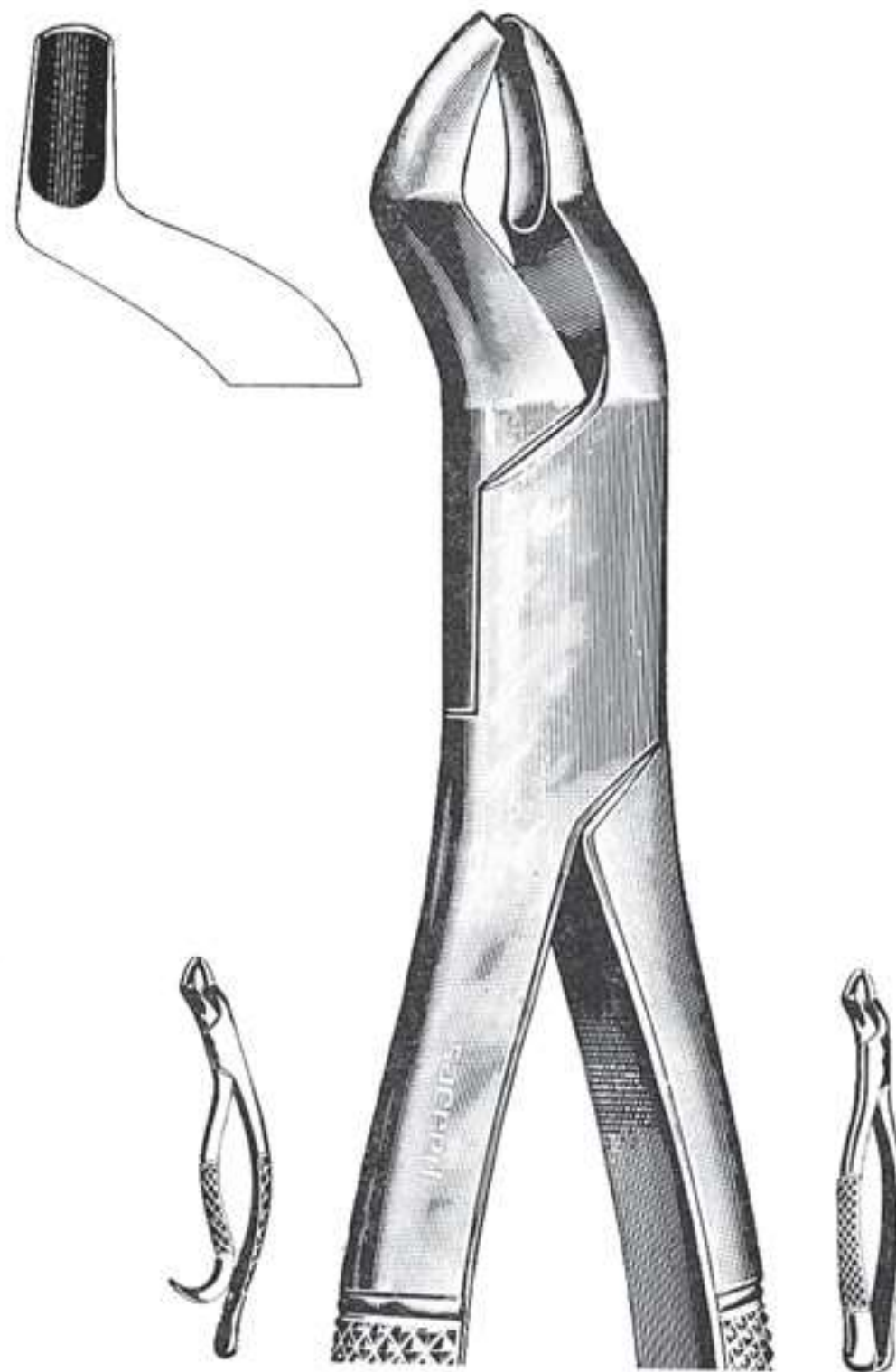

050-095  
Fig. 10 H  
upper molars  
hook - handle



050-096  
Fig. 10 S  
upper molars  
straight - handle

050-097  
Fig. 15  
Lower molars



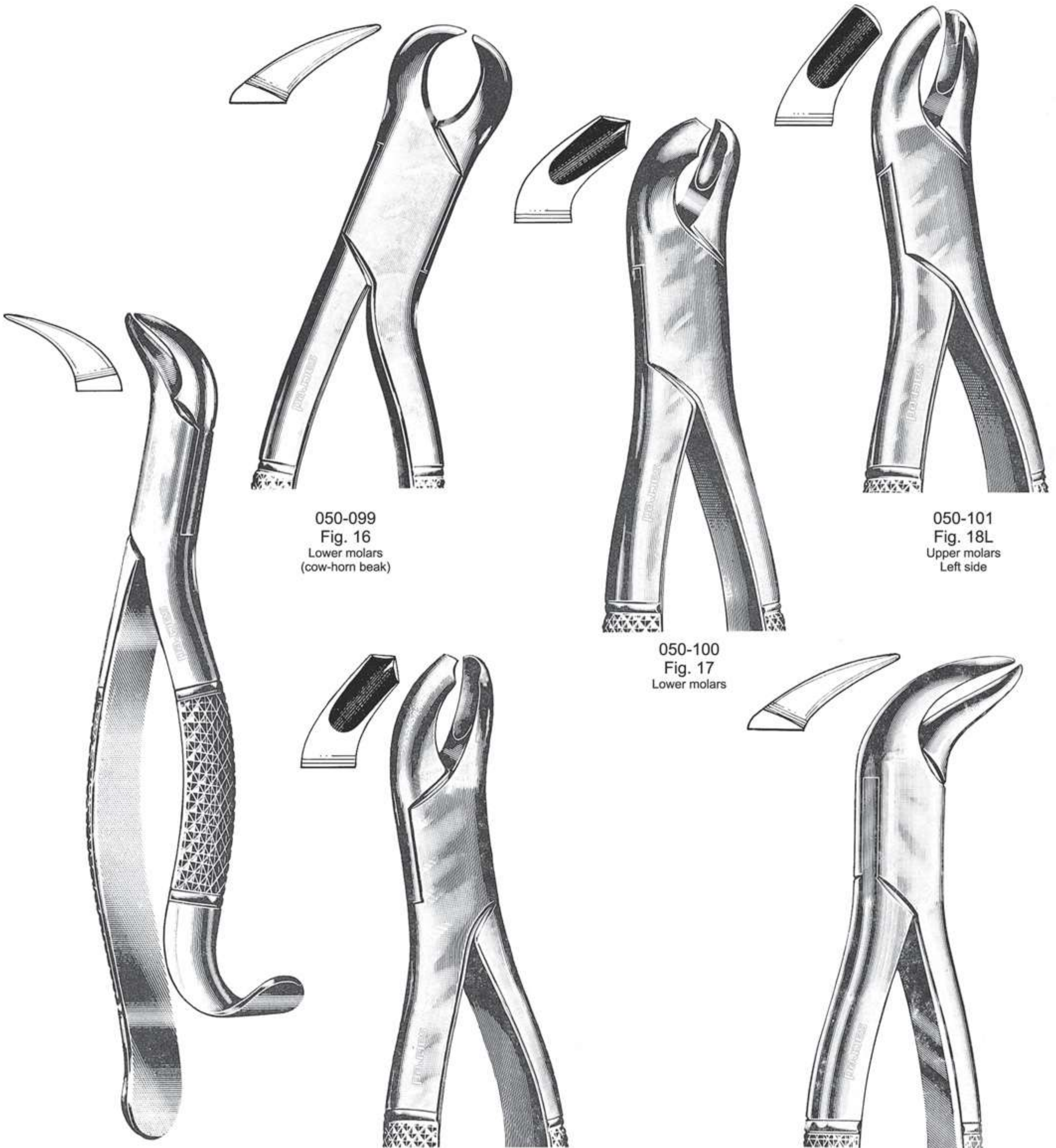

050-099  
Fig. 16  
Lower molars  
(cow-horn beak)

050-101  
Fig. 18L  
Upper molars  
Left side

050-100  
Fig. 17  
Lower molars

050-098  
Fig. 16 S  
Lower molars  
Children

050-102  
Fig. 18R  
Upper molars  
Right side

050-103  
Fig. 23  
Lower molars  
(Cow-horn beak)



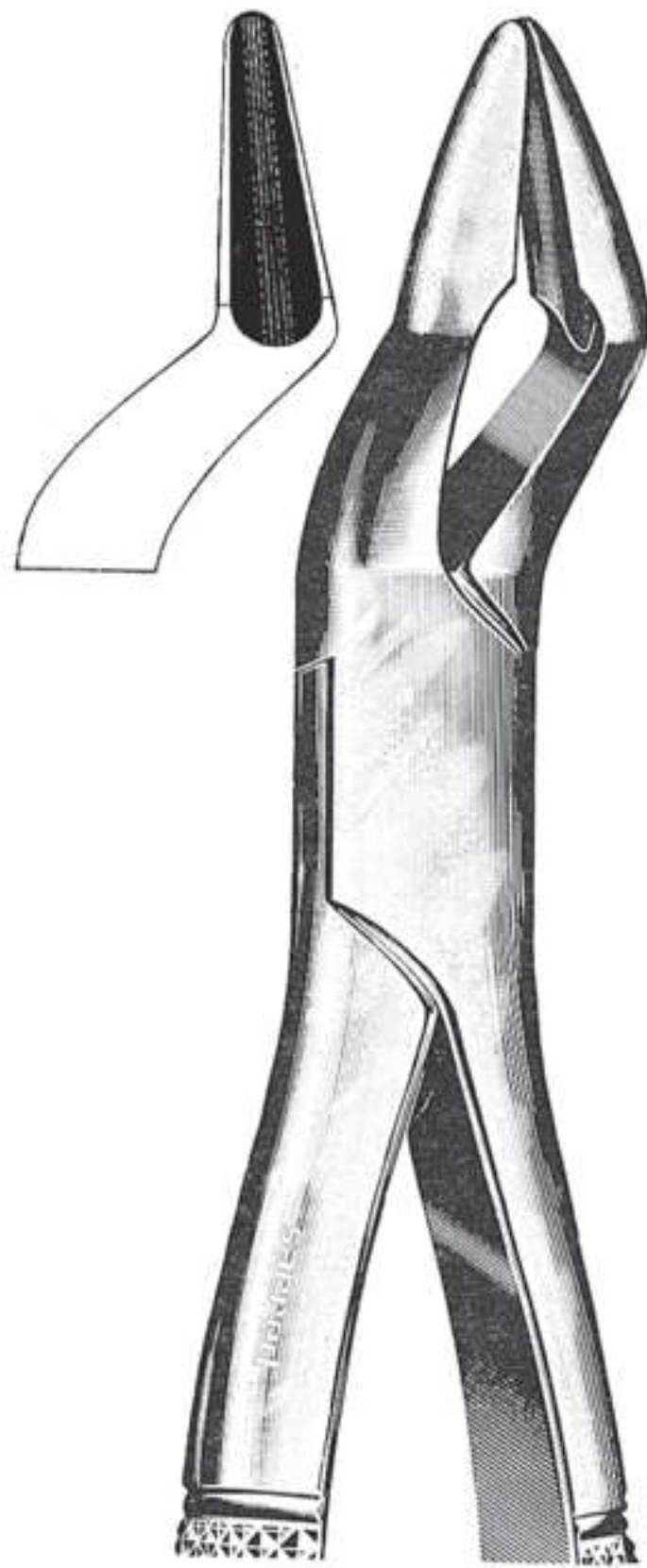

050-104  
Fig. 32  
Upper molars & pre molars  
strong beak

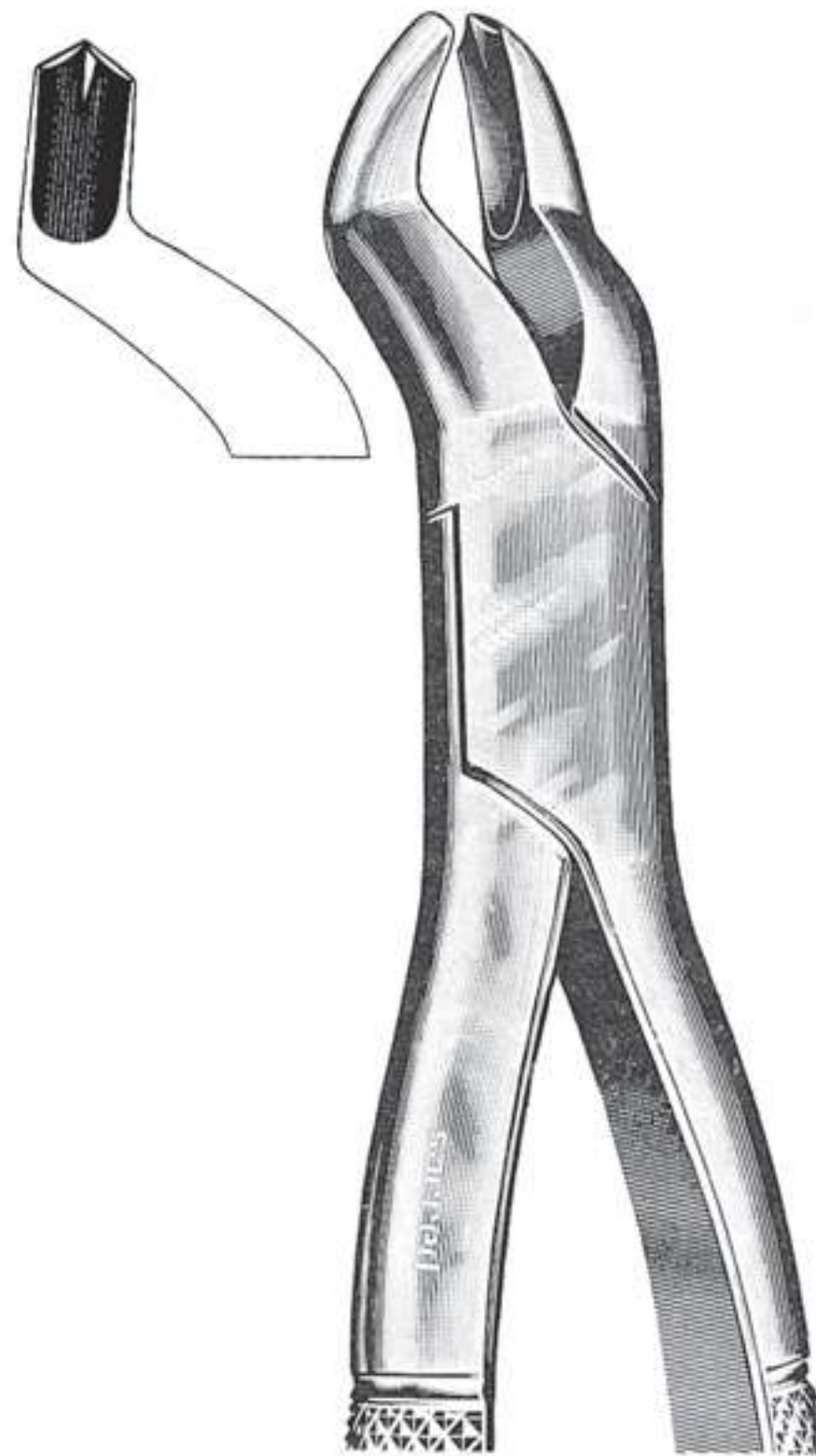

050-105  
Fig. 53 L  
Upper molars  
Left side

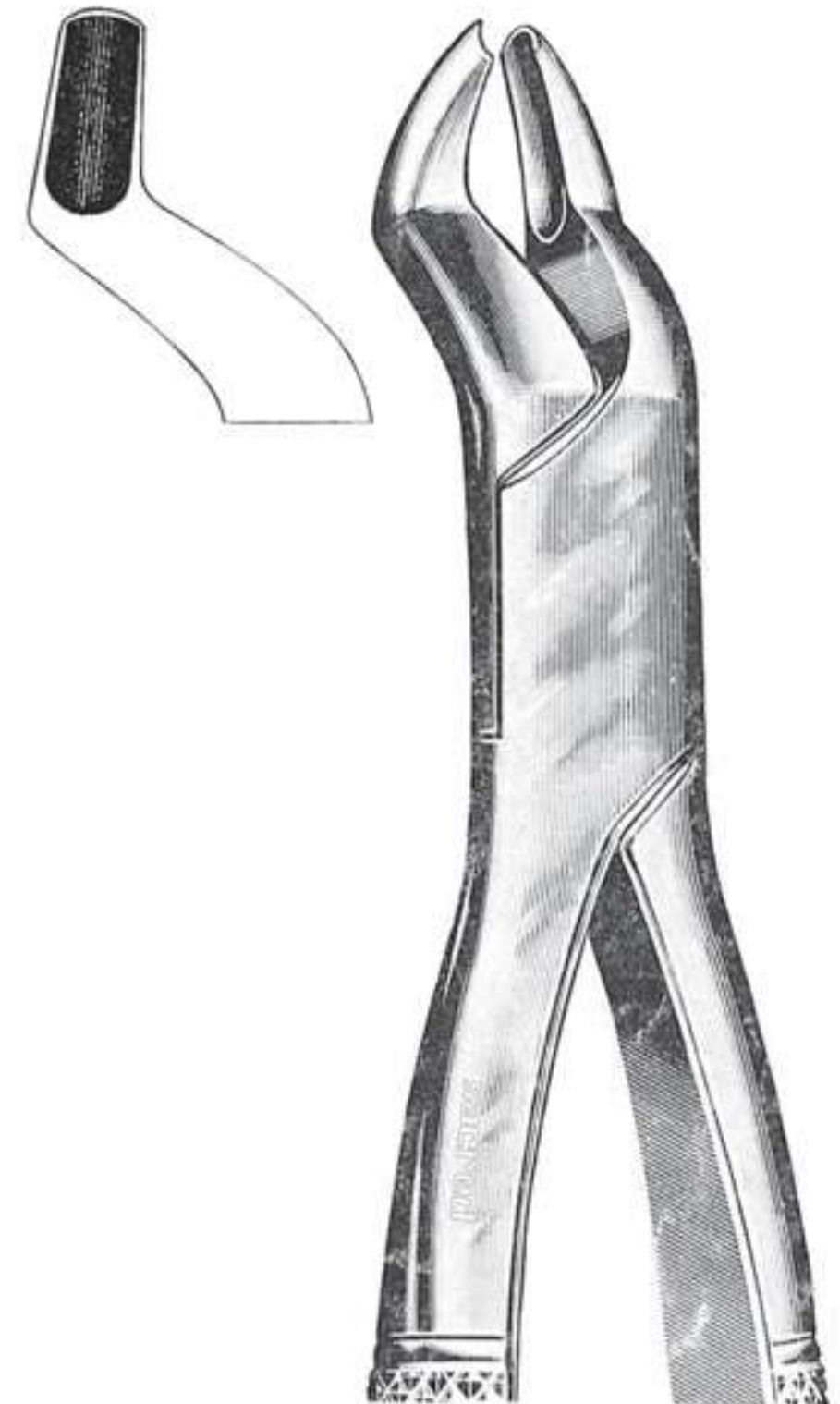

050-106  
Fig. 53 R  
Upper molars  
Right side



050-107  
Fig. 62  
Universal forceps  
for upper teeth & roots

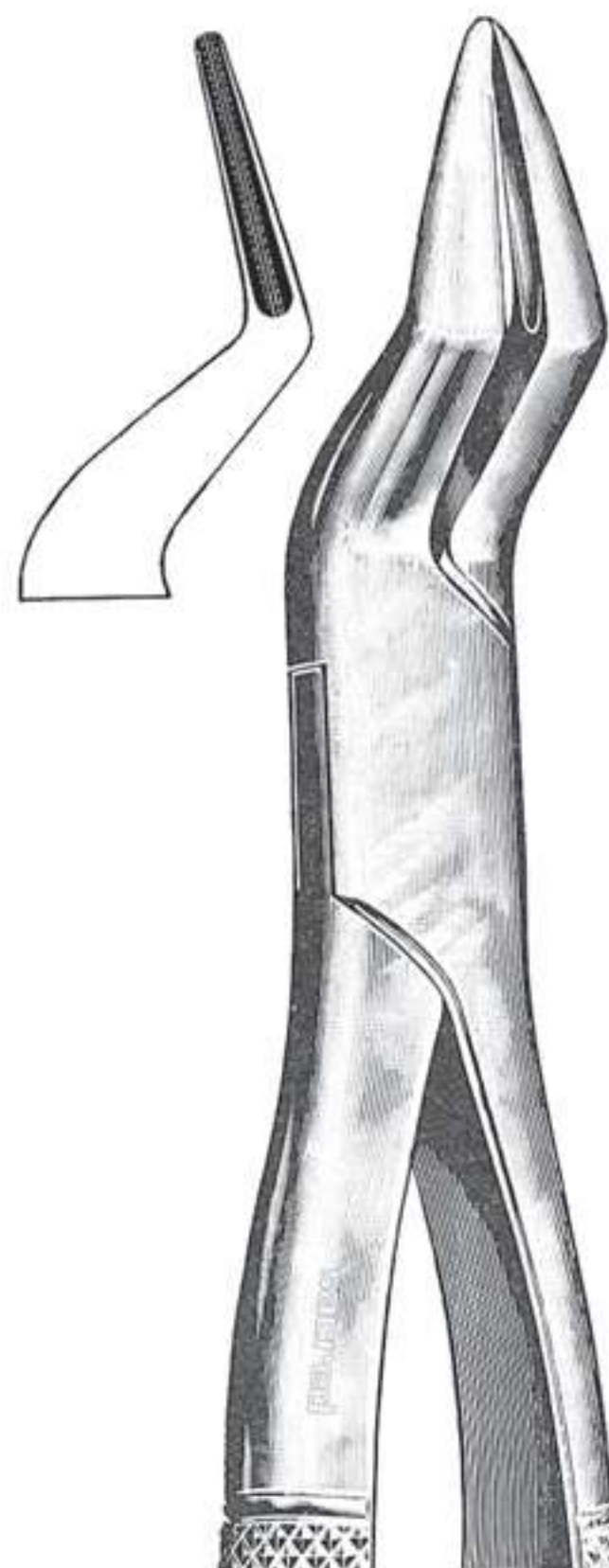

050-108  
Fig. 65  
upper incisors & root

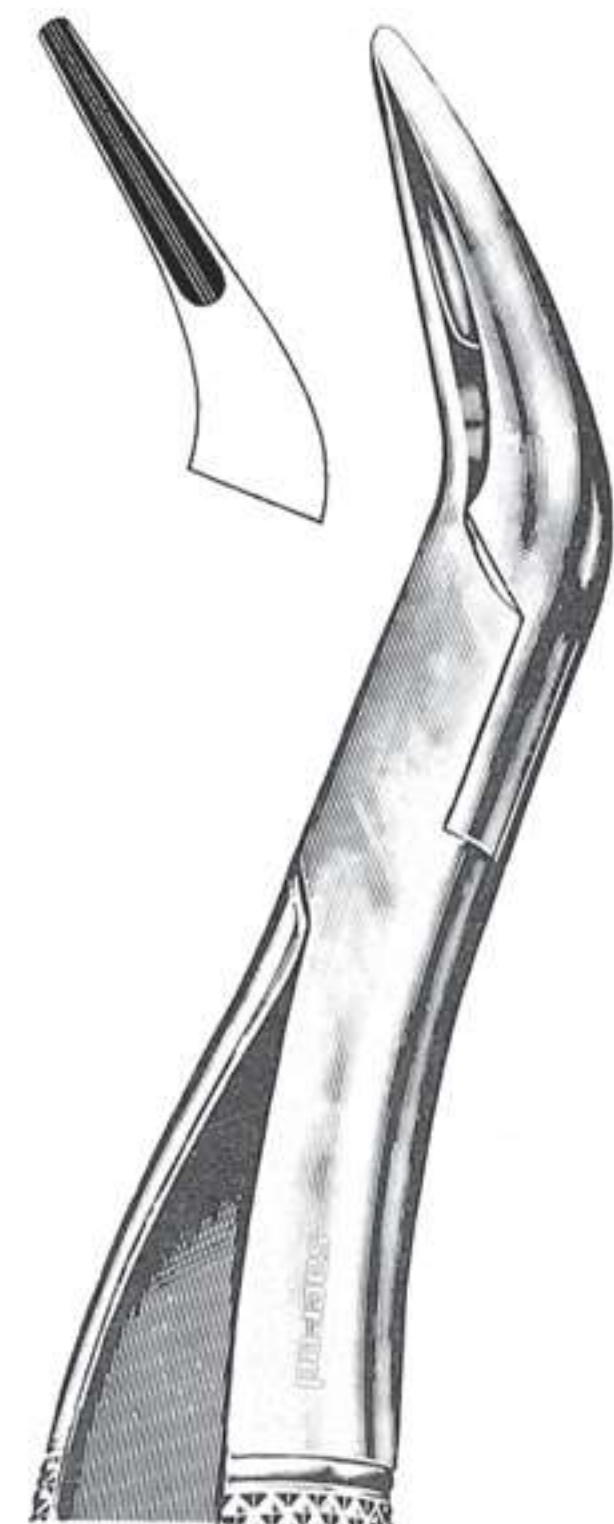

050-109  
Fig. 69  
Fragments & small roots  
Upper & Lower



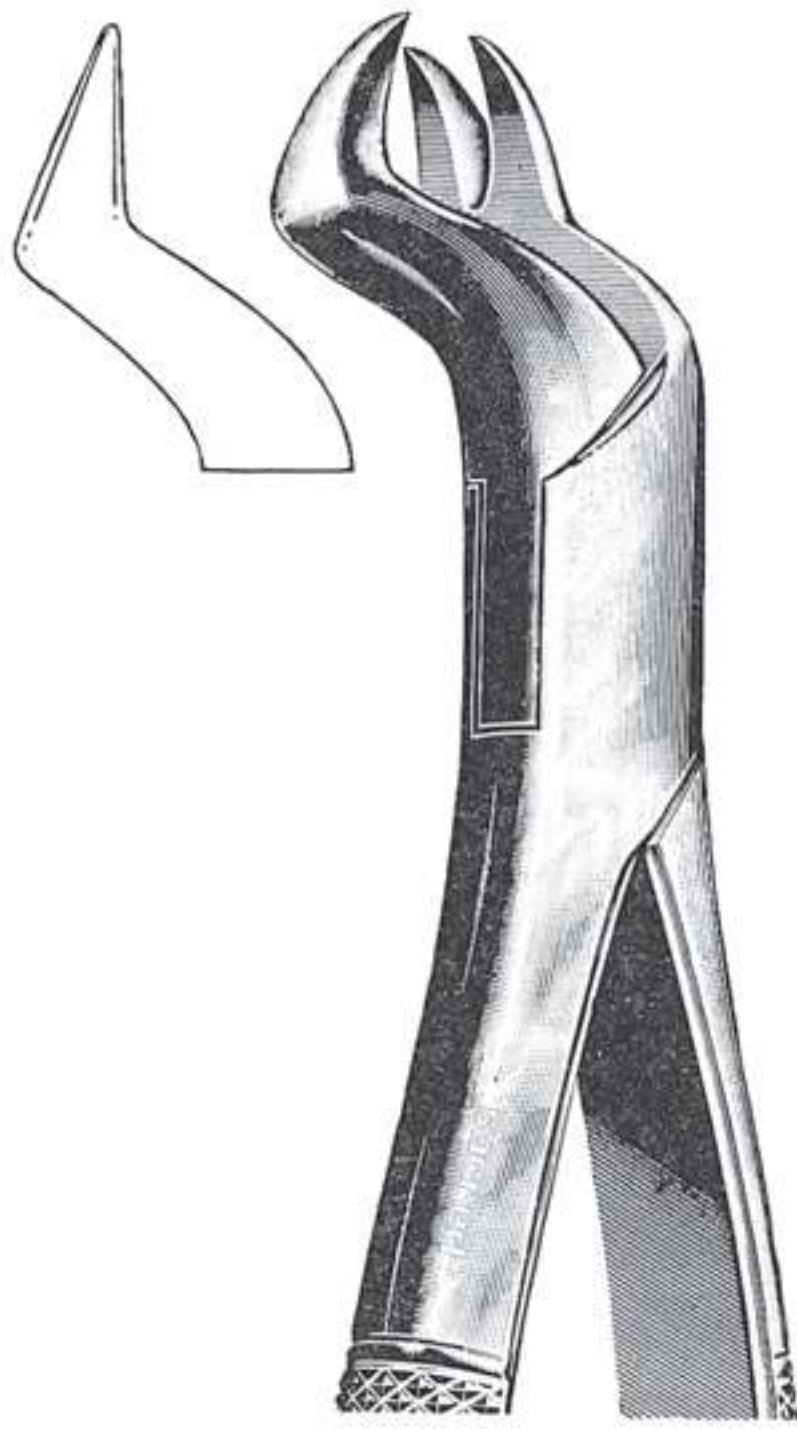

050-110  
Fig. 88R  
Right upper molars

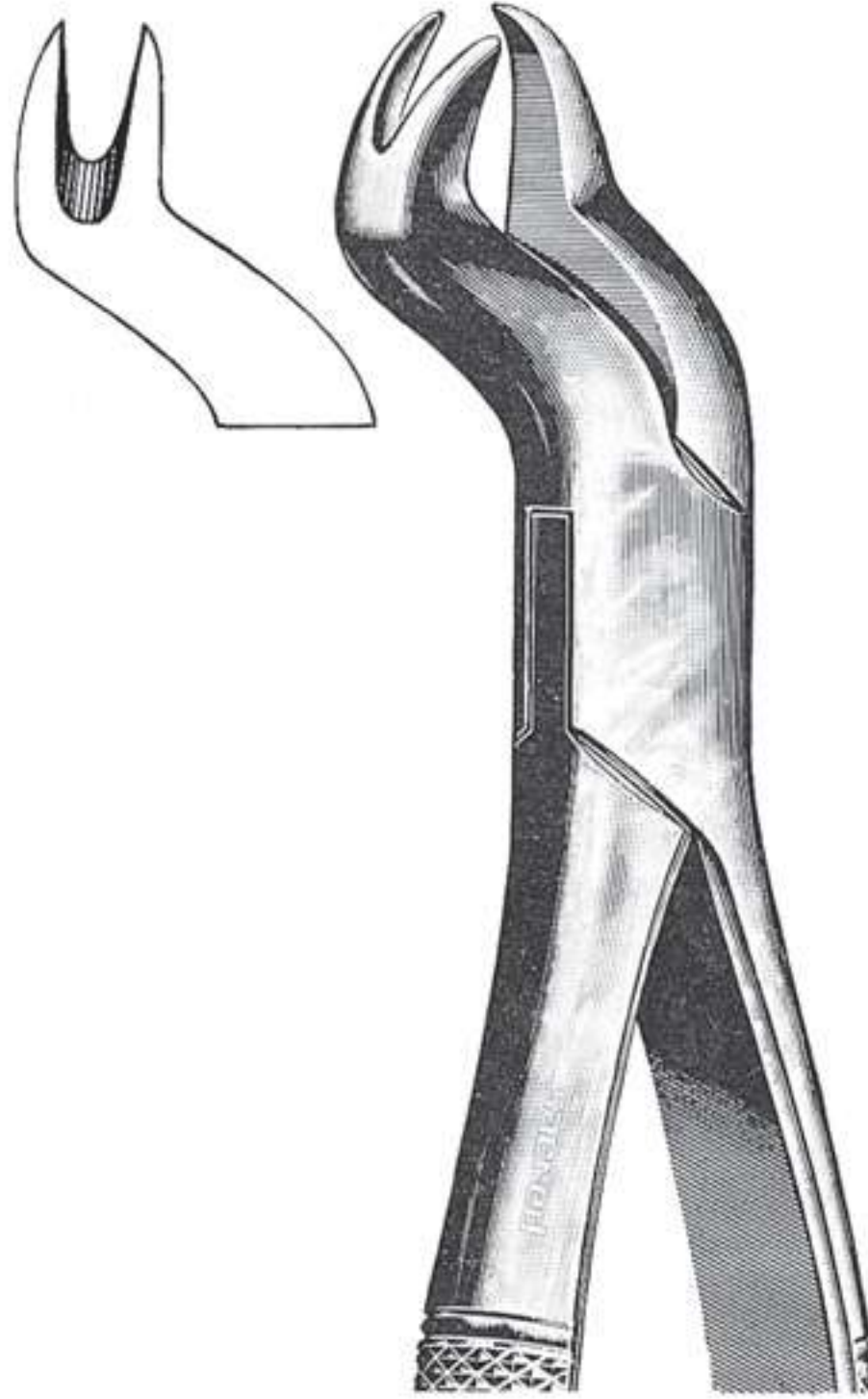

050-111  
Fig. 88L  
Left upper molars

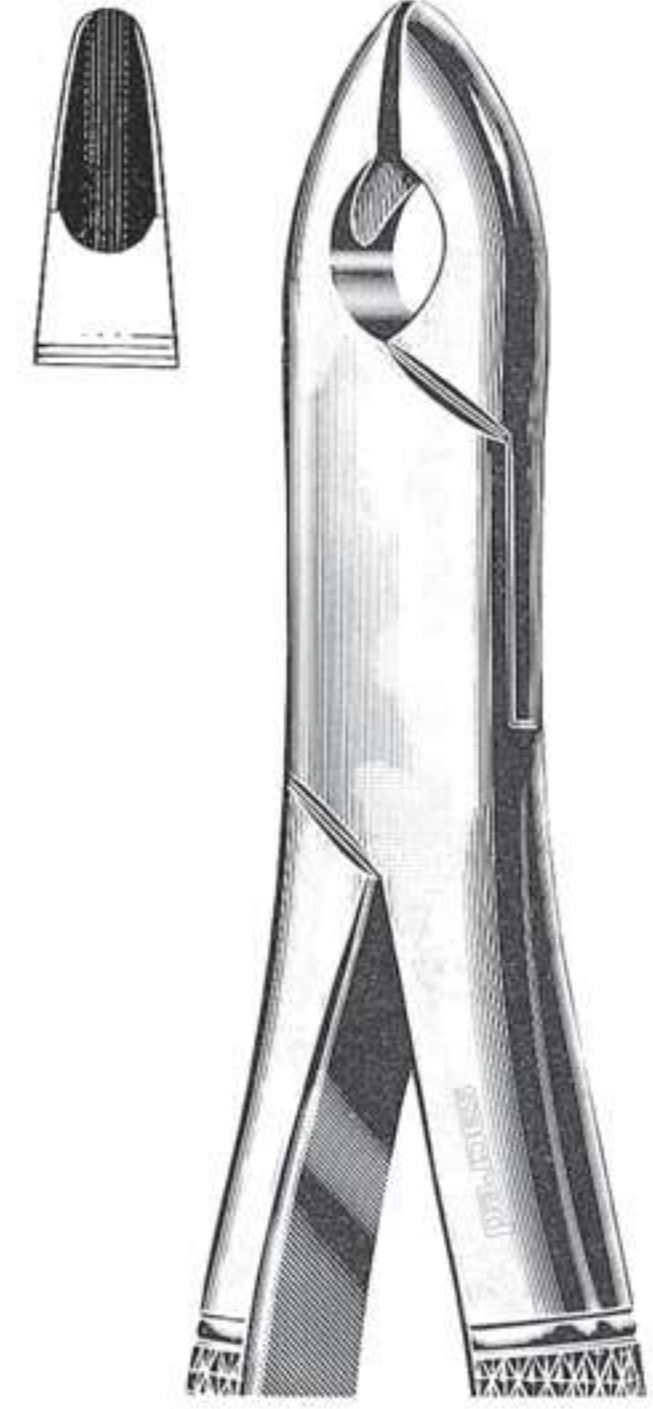

050-112  
Fig. 99C  
upper premolars,  
molar & incisors

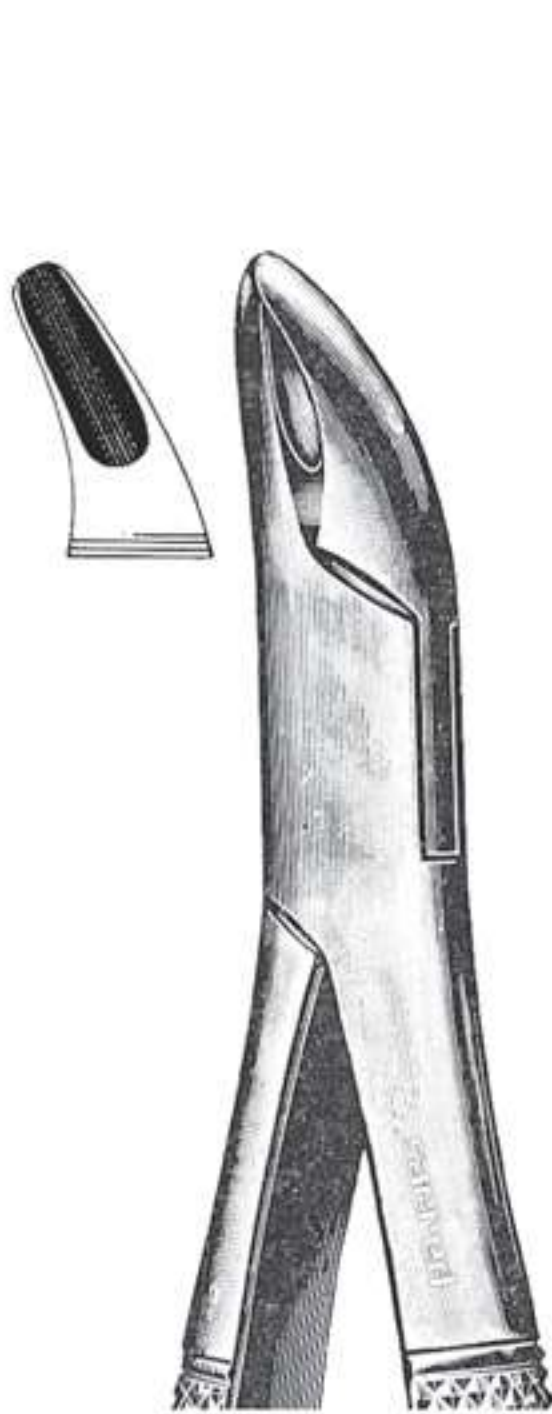

050-113  
Fig. 101  
Universal forceps  
for premolars,

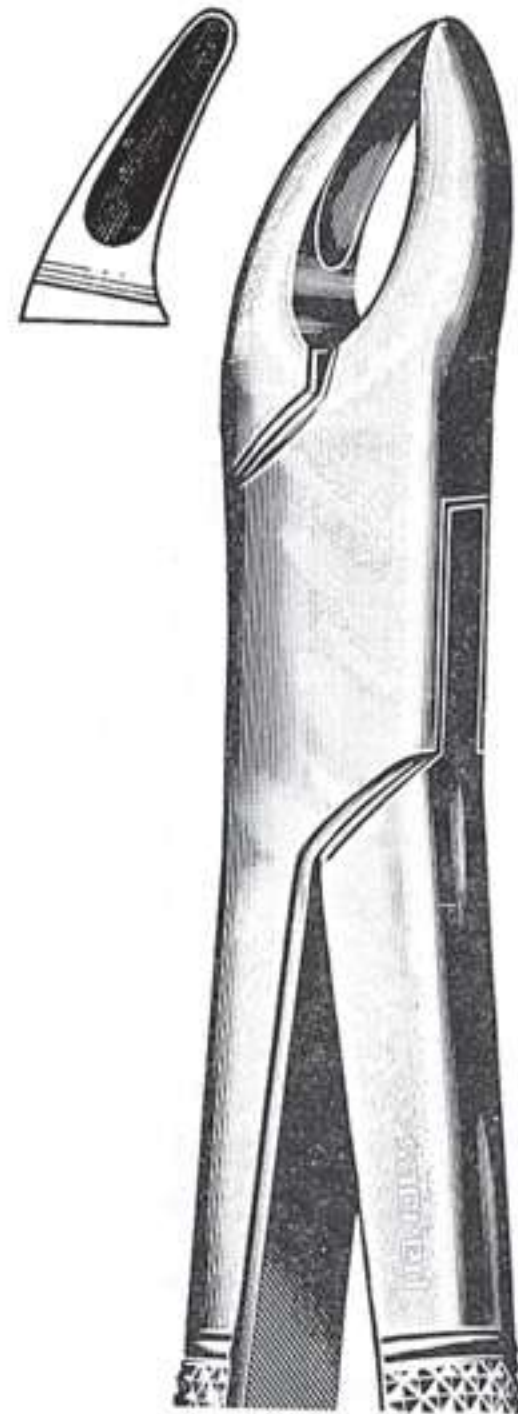

050-114  
Fig. 150  
Upper premolars,  
incisors & roots

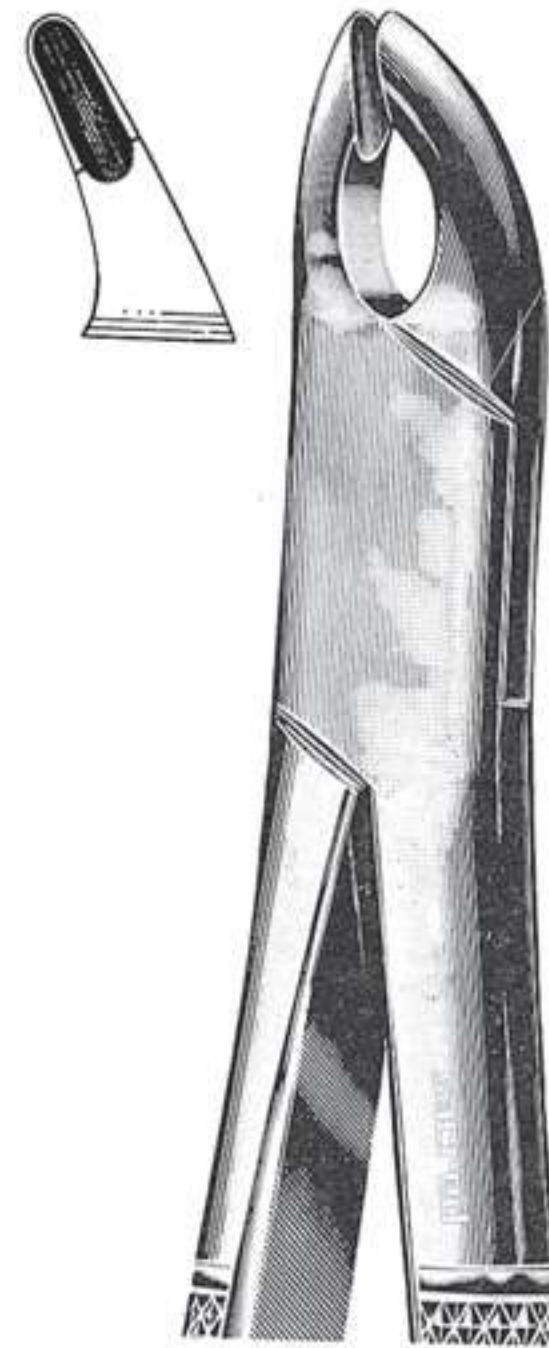

050-115  
Fig. 150A  
Upper premolars,  
incisors & roots

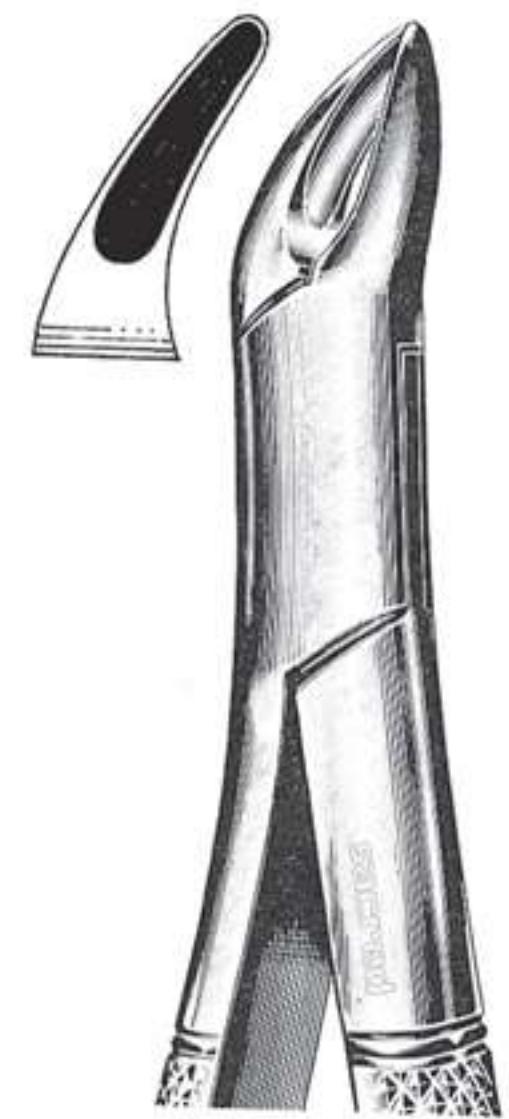

050-116  
Fig. 150S  
Upper premolars,  
incisors & roots  
for children



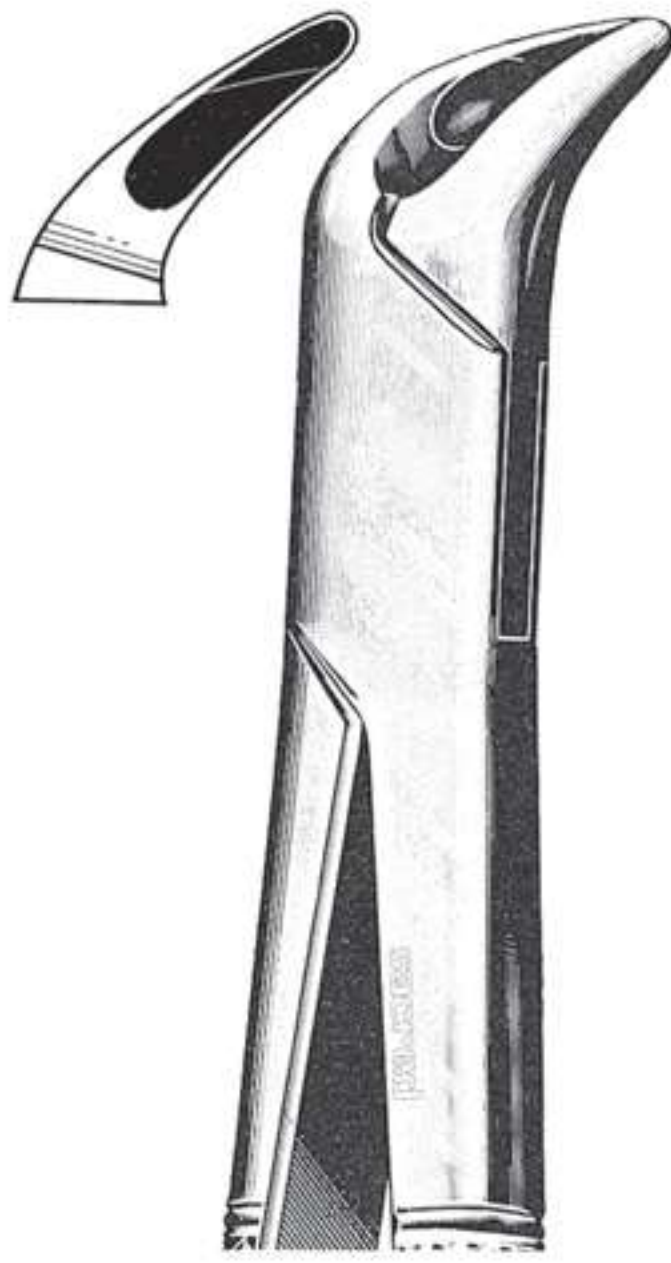

050-117  
Fig. 151  
Lower premolars, incisors & roots



050-118  
Fig. 151A  
Lower premolars, incisors & roots

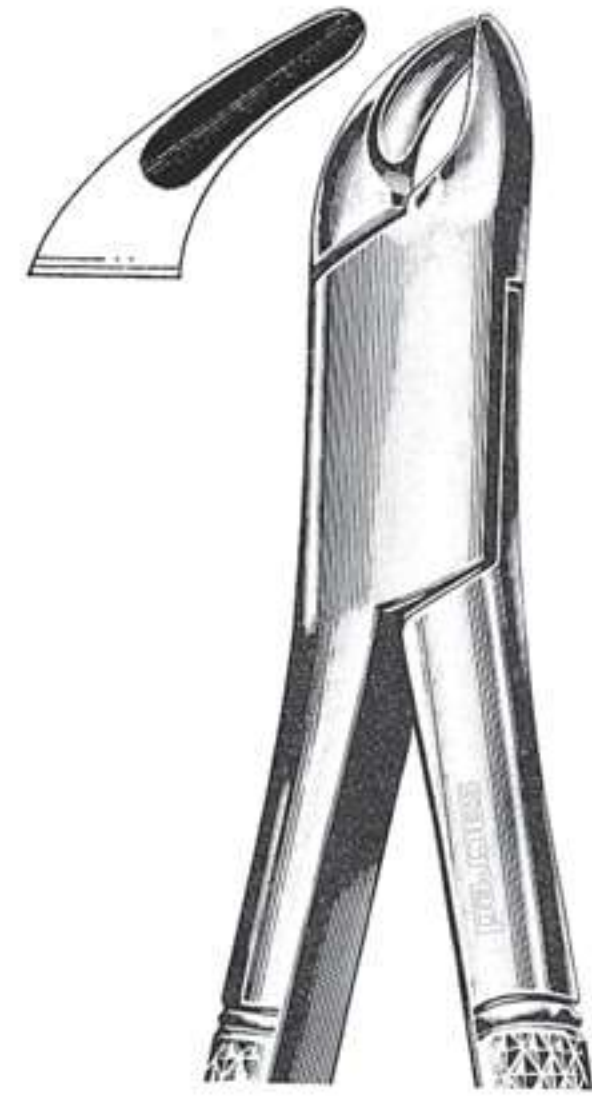

050-119  
Fig. 151S  
Lower premolars, incisors & roots  
for children

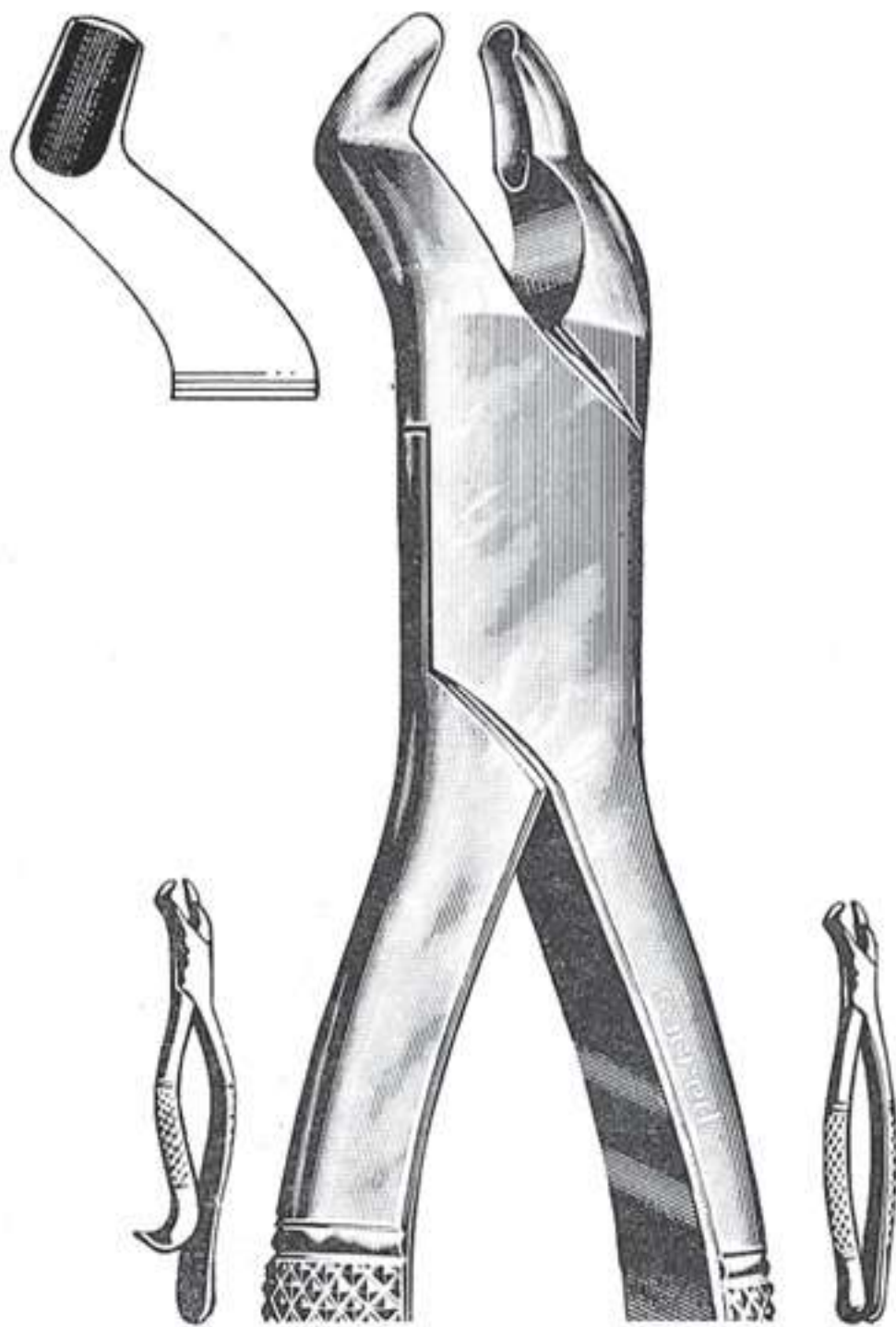

050-120  
Fig. 210H  
Upper wisdoms  
with hook handle

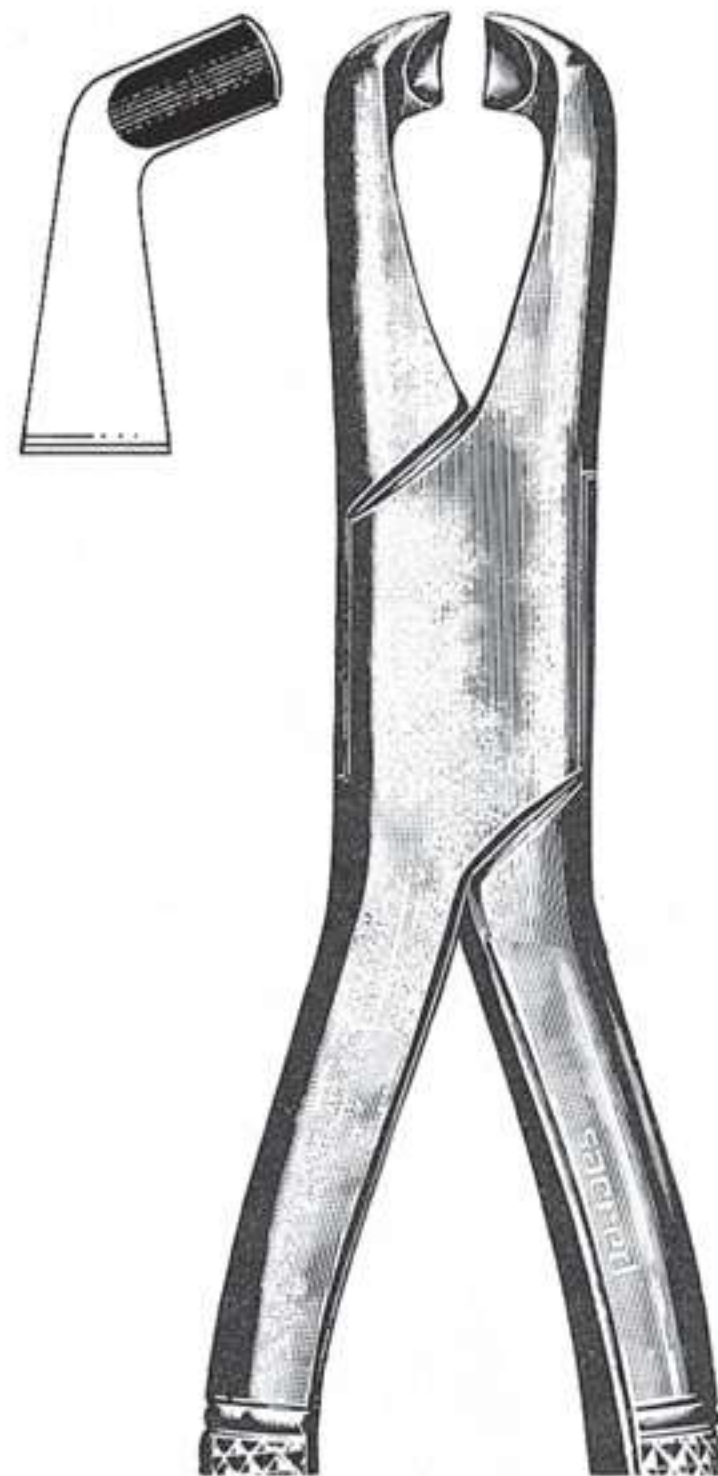

050-121  
Fig. 210S  
Upper wisdoms  
with straight handle

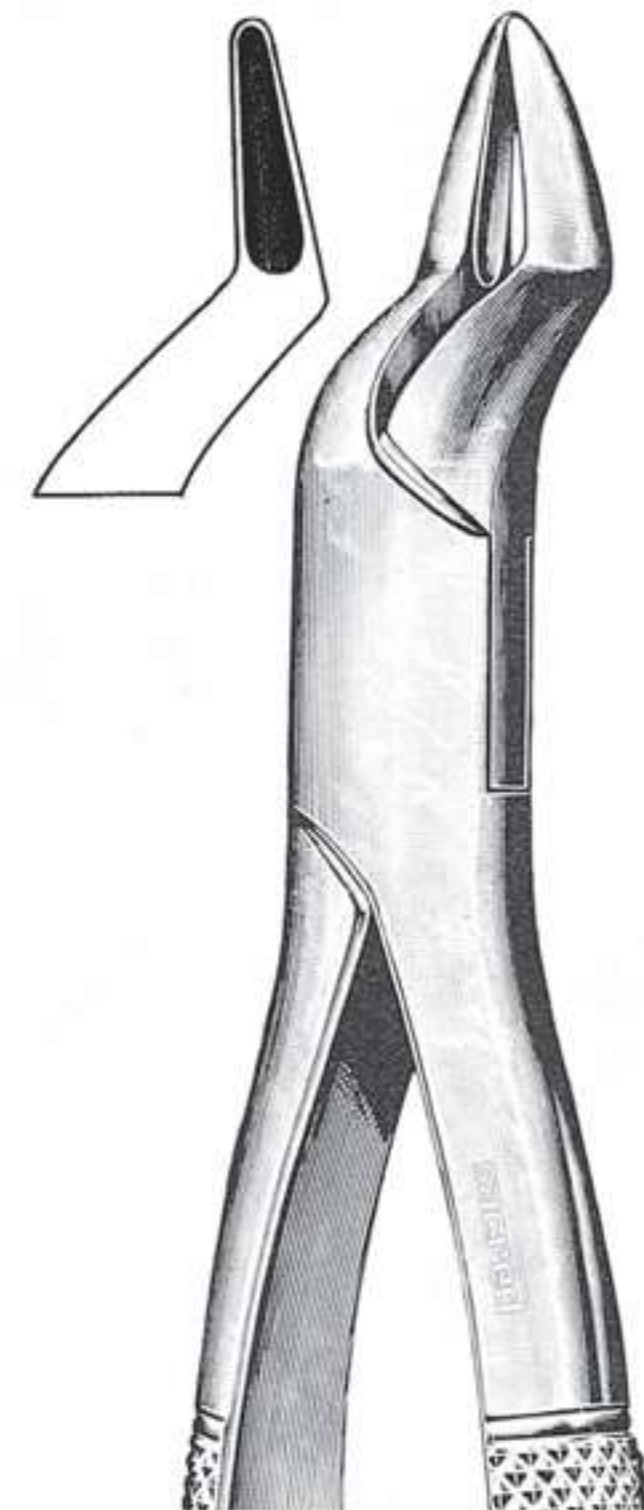

050-122  
Fig. 222  
Lower wisdoms

050-123  
Fig. 286  
Upper roots, premolars & incisors



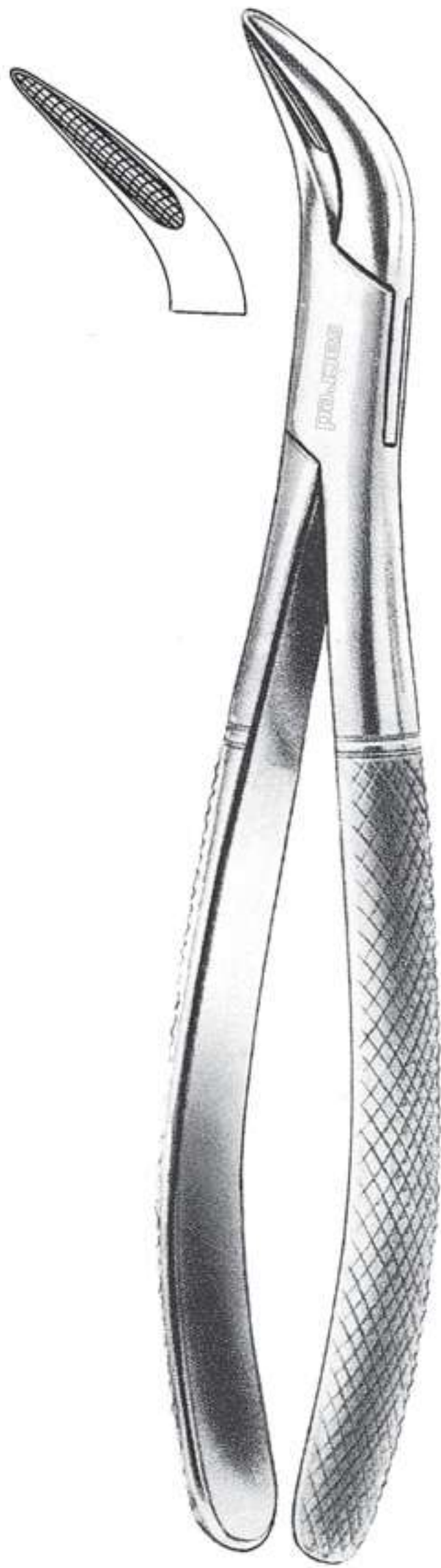

050-124  
Fig. 1  
Lower roots

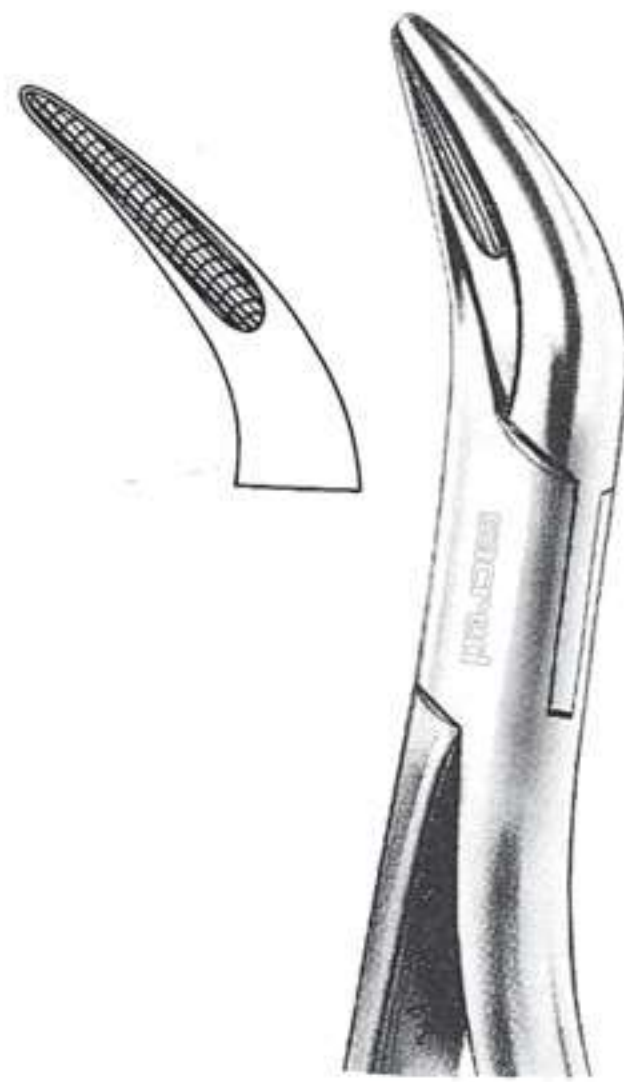

050-125  
Fig. 2  
Upper roots



050-126  
Albrecht  
16 cm



050-127  
Albrecht  
16 cm

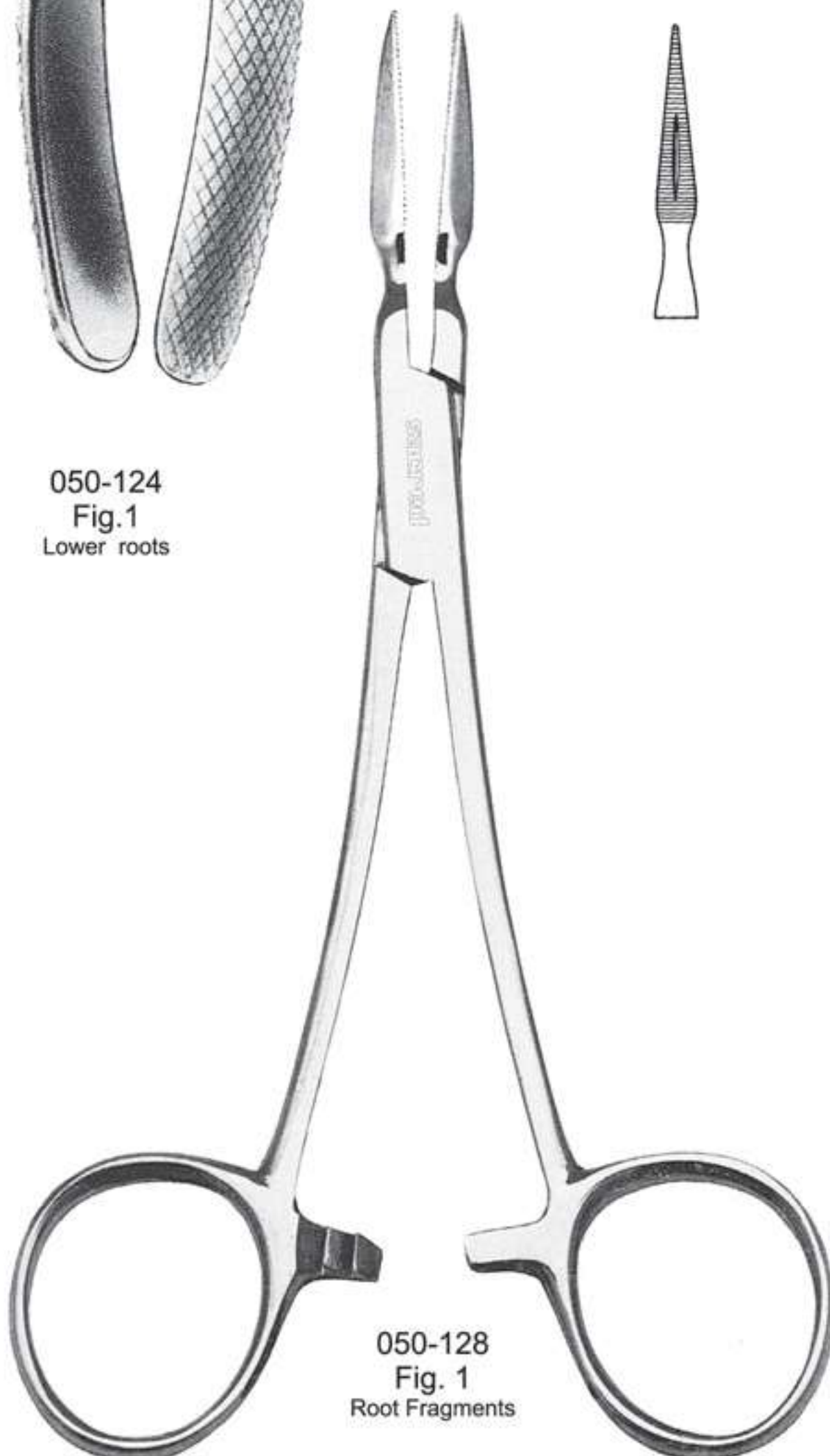

050-128  
Fig. 1  
Root Fragments



050-129  
Fig. 2  
Root Fragments





050-130  
Blumenthal  
15 cm



050-131  
Blumenthal 45°  
14,5 cm



050-132  
Blumenthal 90°  
14 cm

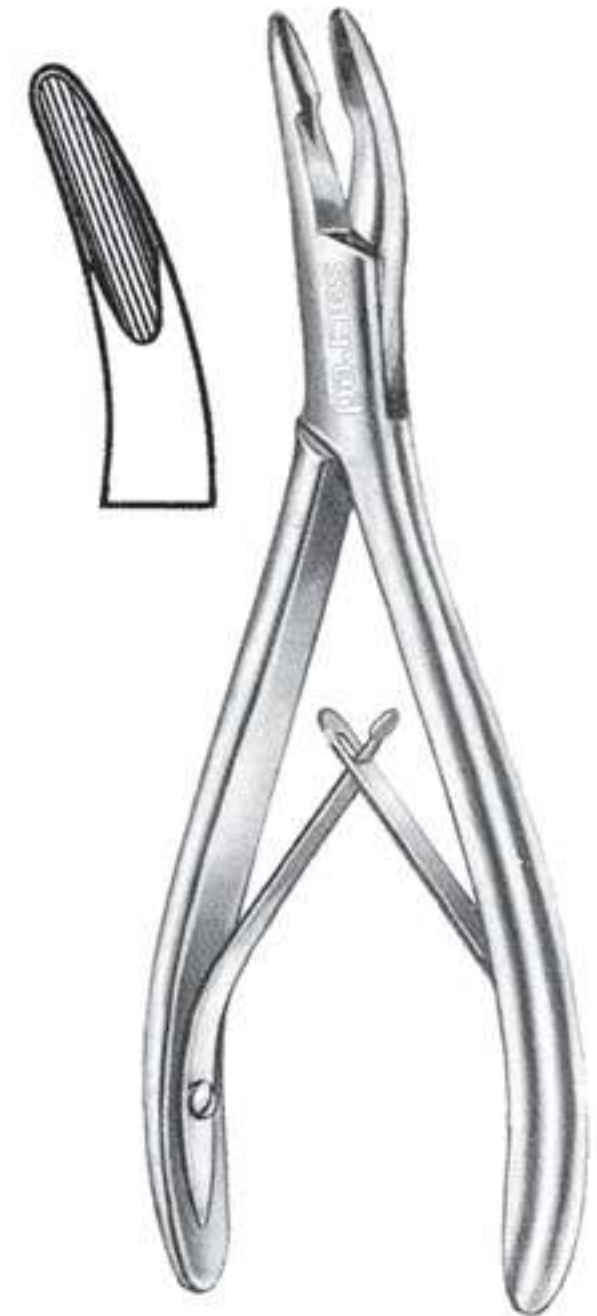

050-133  
Mead 1A  
16,5 cm



050-134  
Beyer  
18 cm  
Multiple Action

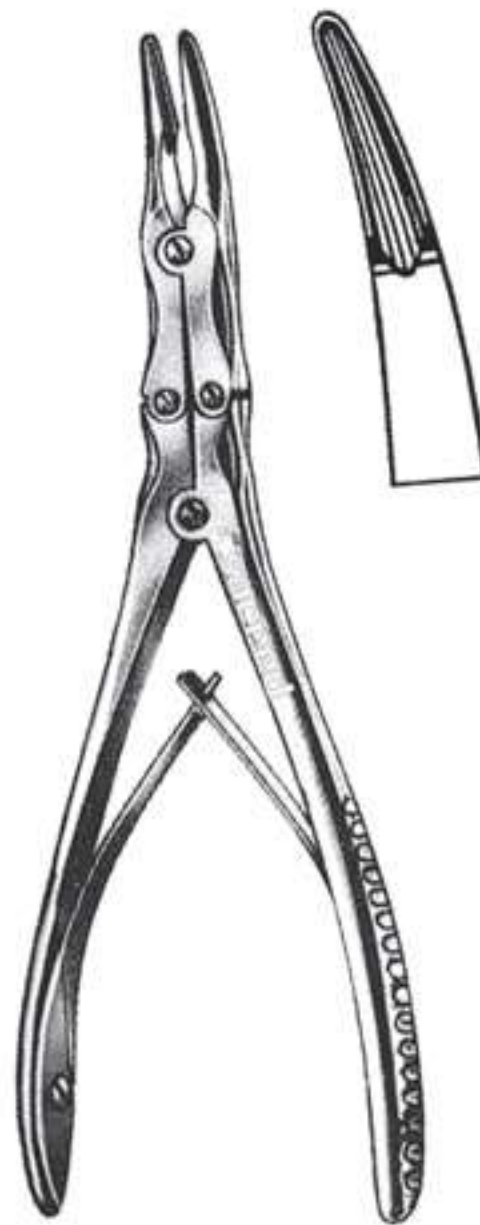

050-135  
Ruskin-mini  
15,5 cm



050-136  
Luer  
15 cm



050-137  
Friedman  
14 cm



050-138  
Mini-Friedman  
12 cm



Root Elevators  
Set of 7  
075-101S



075-001  
Fig.1B  
Bein



075-002  
Fig.2B  
Bein



075-003  
Fig.3B  
Bein



075-004  
Fig.4B  
Bein



075-005  
Fig.5B  
Bein



075-006  
Fig.6B  
Bein



075-007  
Fig.4SA  
Schmeckebier-Apexo



075-008  
Fig.5SA  
Schmeckebier-Apexo



075-009  
Fig.34S  
Seldin



075-010  
Fig.34  
Seldin



075-011  
Fig.2S  
Seldin



075-012  
Fig.3S  
Seldin



075-013  
Fig.1F  
Flohr



075-014  
Fig.2F  
Flohr



075-015  
Fig.3F  
Flohr









075-031  
Fig.A  
Cogswell



075-032  
Fig.B  
Cogswell



075-033  
Fig.301  
Apexo



075-034  
Fig.302  
Apexo



075-035  
Fig.303  
Apexo



075-036  
Fig.301W  
Seldin



075-037  
Fig.304W  
Seldin



075-038  
Fig.1H  
Heidbrink



075-039  
Fig.2H  
Heidbrink



075-040  
Fig.40H  
Heidbrink



075-041  
Fig.41H  
Heidbrink



075-042  
Fig.46



075-043  
Fig.46R





075-045  
Fig.45  
Cryer



075-046  
Fig.25  
Cryer



075-047  
Fig.26  
Cryer



075-048  
Fig.31  
Cryer



075-049  
Fig.32  
Cryer



075-050  
Fig.80



075-051  
Fig.81



075-052  
Fig.81A



075-053  
Fig.81E



075-054  
Fig.190



075-055  
Fig.191



075-056  
Fig.23



075-057  
Fig.24



075-058  
Fig.98









075-075  
Fig.1  
Bein



075-076  
Fig.2  
Bein



075-077  
Fig.3  
Bein



075-078  
Fig.4  
Bein



075-079  
Fig.5  
Bein



075-080  
Fig.6  
Bein



075-081  
Fig.1



075-082  
Fig.2



075-083  
Fig.2  
Flohr



075-084  
Fig.3  
Flohr



075-085  
Fig.7  
Cryer



075-086  
Fig.8  
Cryer







100-001\*  
Fig.1  
Adson  
12 cm



100-002  
Fig.1  
Adson 1x2  
12 cm



100-003  
Fig.1  
Semken-Taylor  
12,5 cm



100-004  
Fig.2  
Semken-Taylor  
12,5 cm



100-005  
Fig.1  
Semken-Taylor 1x2  
12,5 cm



100-006  
Fig.2  
Semken-Taylor 1x2  
12,5 cm



100-007  
12 cm



100-008  
11,5 cm



100-009  
11,5 cm



100-010  
11,5 cm



\* Also Available in Tungsten Carbide Inserts



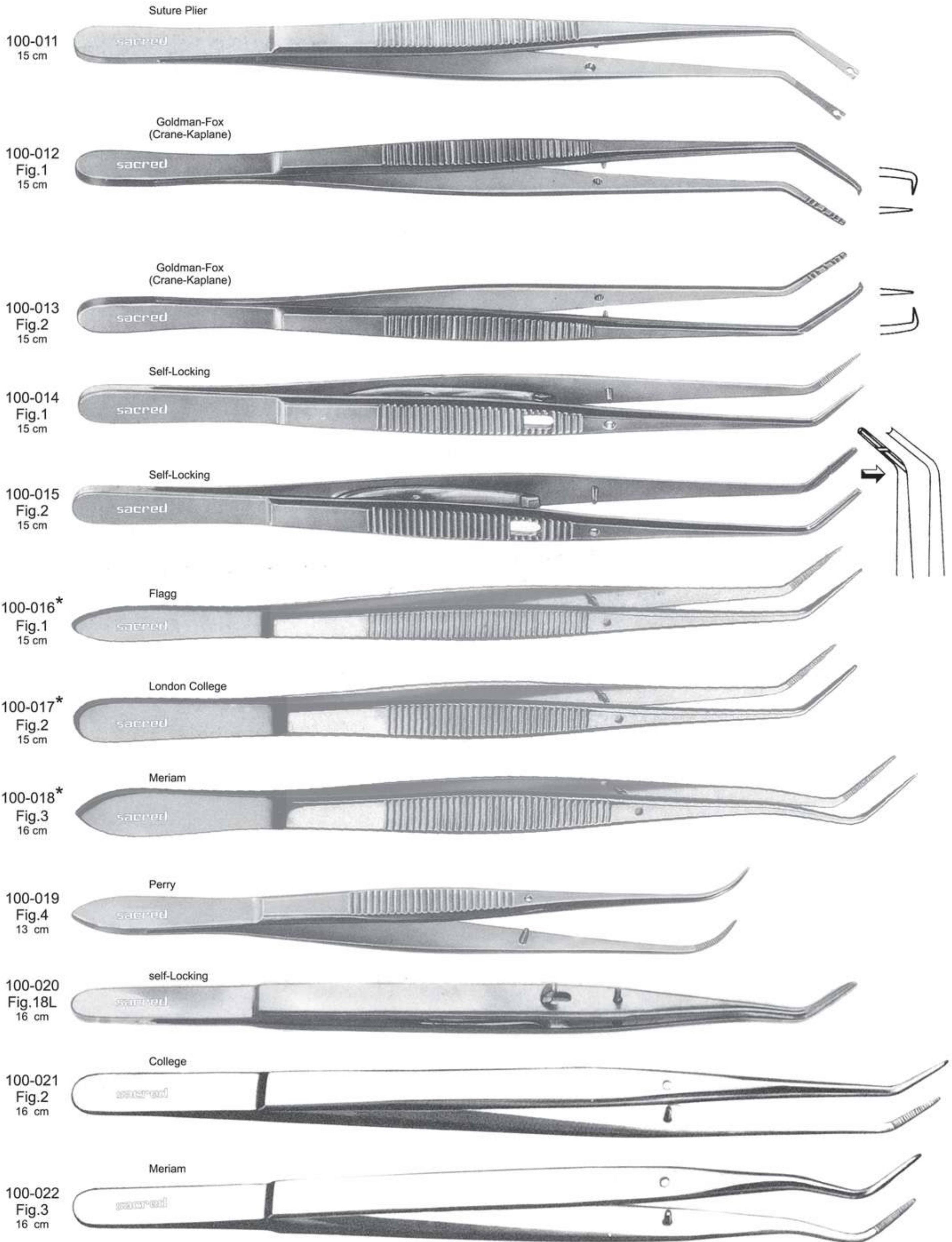

\*Also Available in Tungsten Carbide Inserts





125-001  
Fig.1  
12cm  
Straight



125-002  
Fig.2  
12cm  
Curved



125-003  
Fig.1  
13cm  
Goldman-Fox  
Saw edge  
Straight

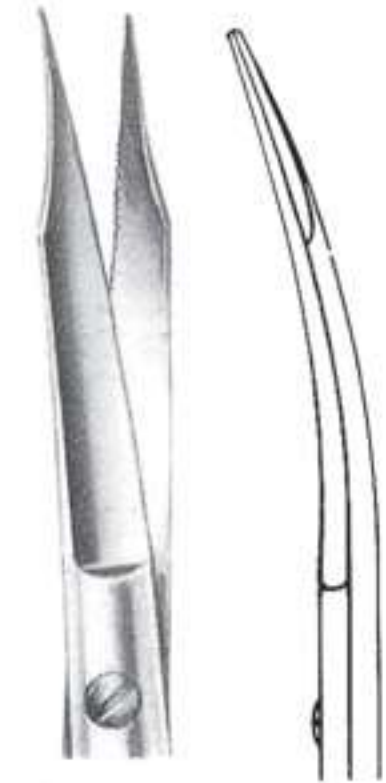

125-004  
Fig.2  
13cm  
Goldman-Fox  
Saw edge  
Curved



125-005  
Fig.1  
11,5cm  
Iris  
Straight

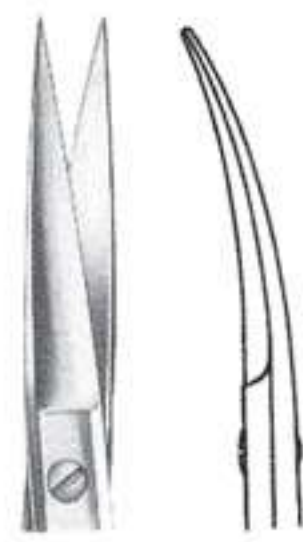

125-006  
Fig.2  
11,5cm  
Iris  
Curved



125-007  
Fig.3  
11,5cm  
Iris



125-008  
Fig.1  
11,5cm  
Angular, Saw edge



125-009  
Fig.2  
11,5cm  
Angular



Curved, saw edge

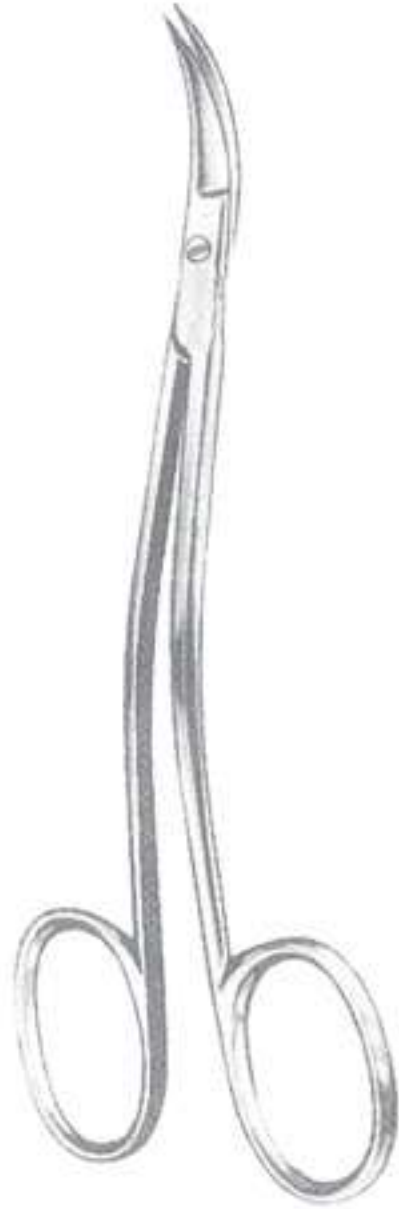

125-010  
Fig.1  
La Grange  
10,5 cm

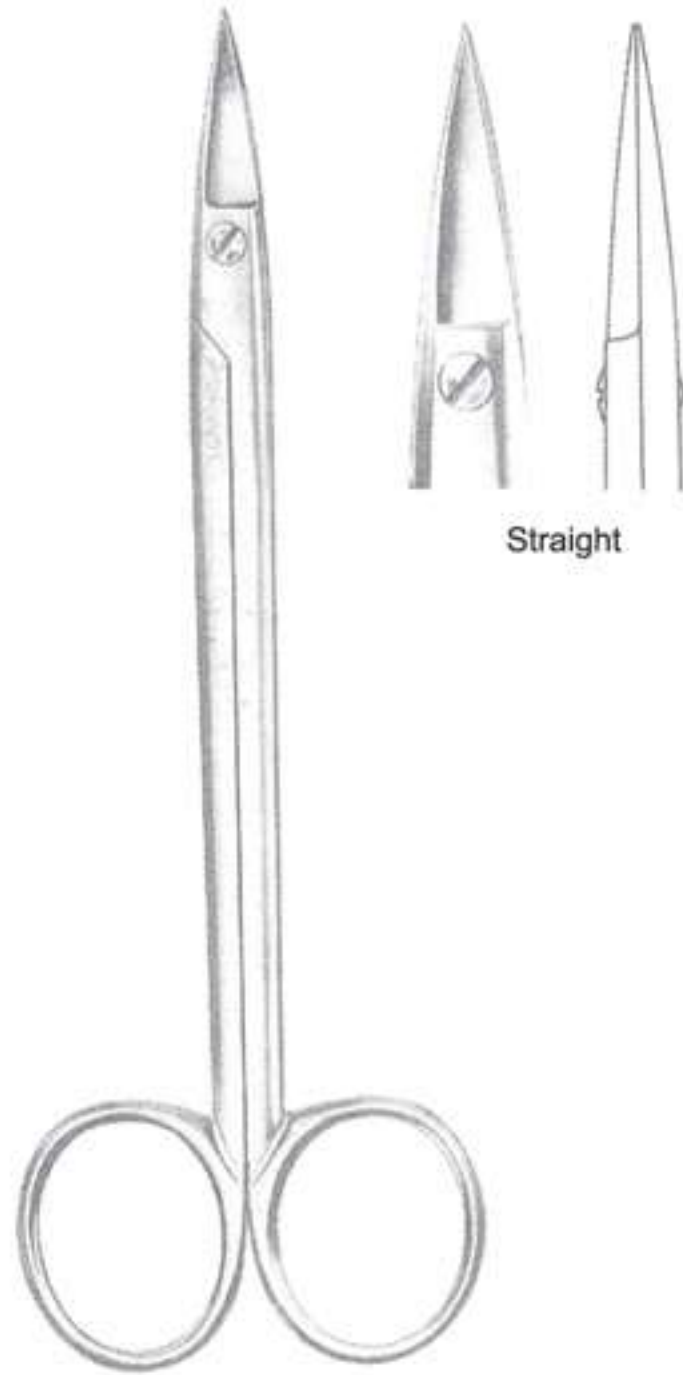

125-011  
Fig.1  
Quinby  
12,5 cm

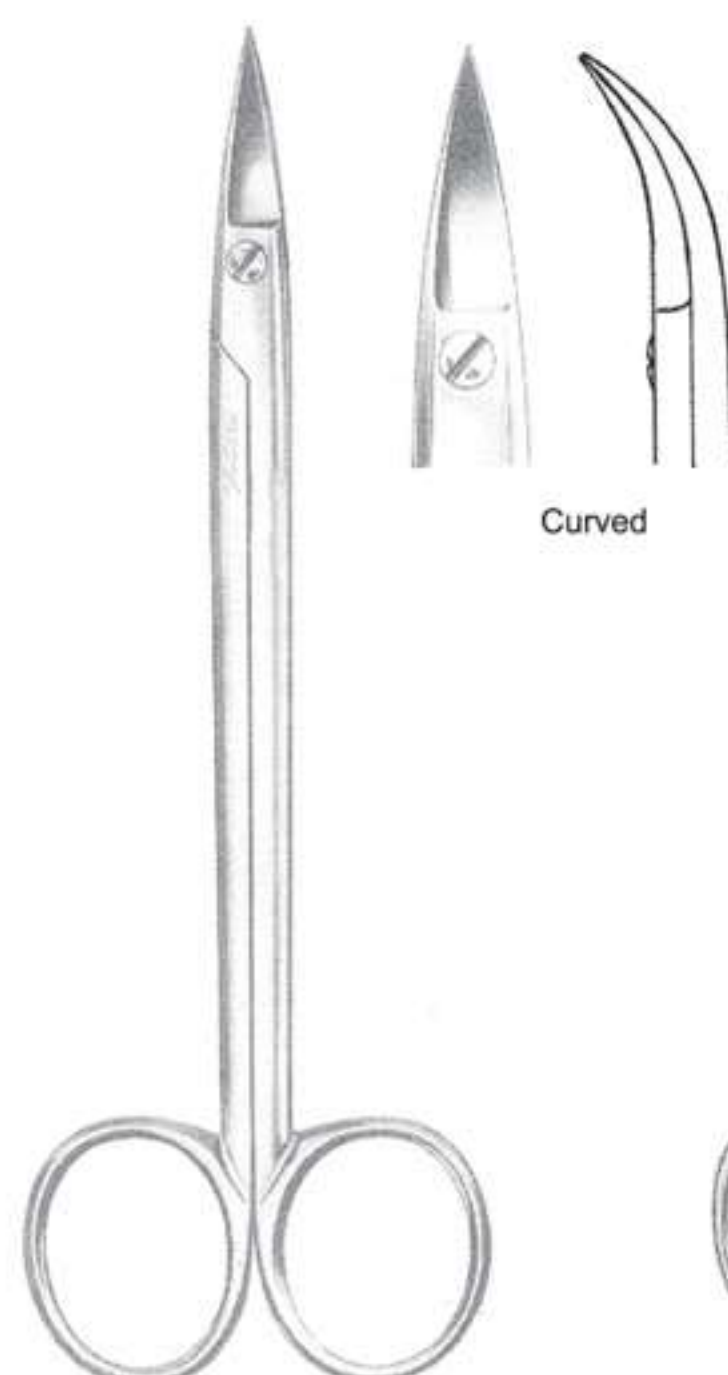

125-012  
Fig.2  
Quinby  
12,5 cm

Curved, saw edge

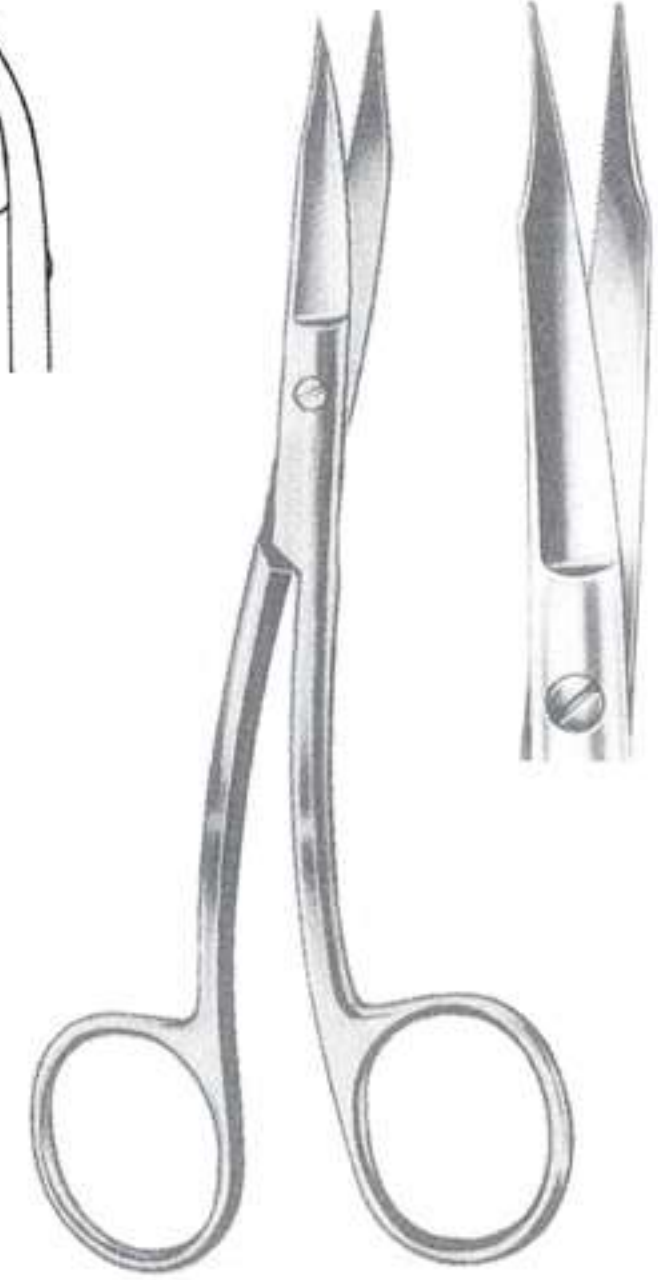

125-013  
Fig.3  
Goldman-Fox (Special)  
13 cm

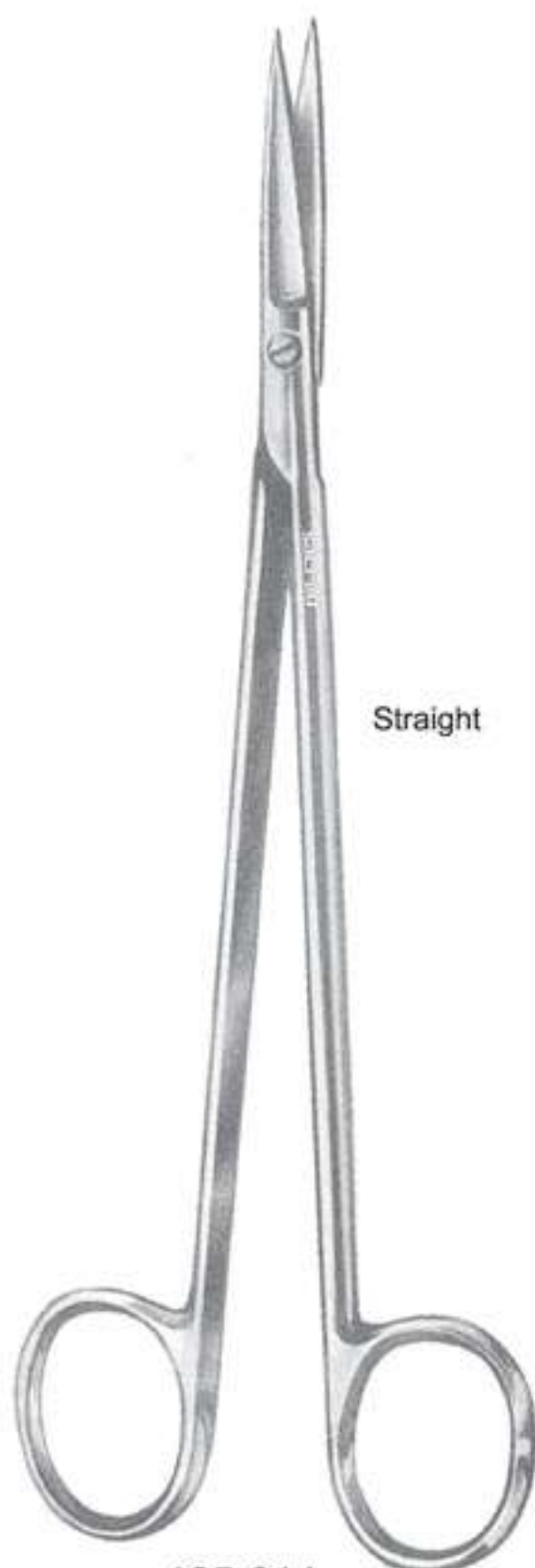

Straight

125-014  
Fig.1  
Kelly  
16 cm

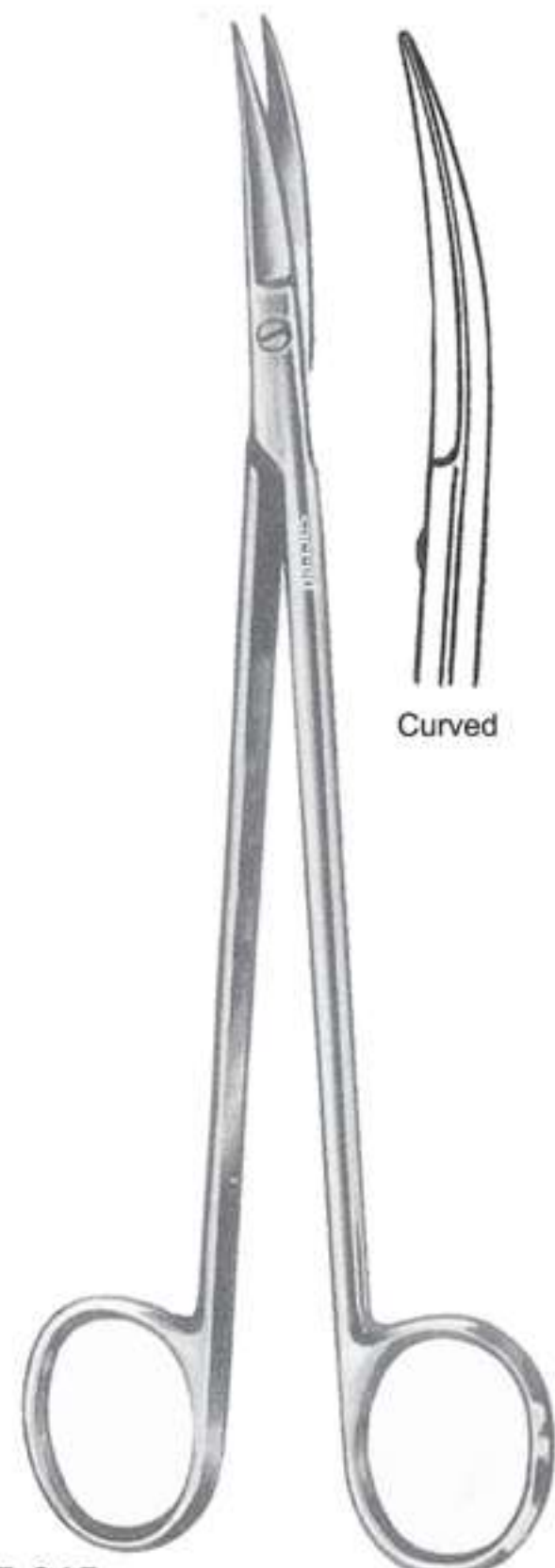

Curved

125-015  
Fig.2  
Kelly  
16 cm

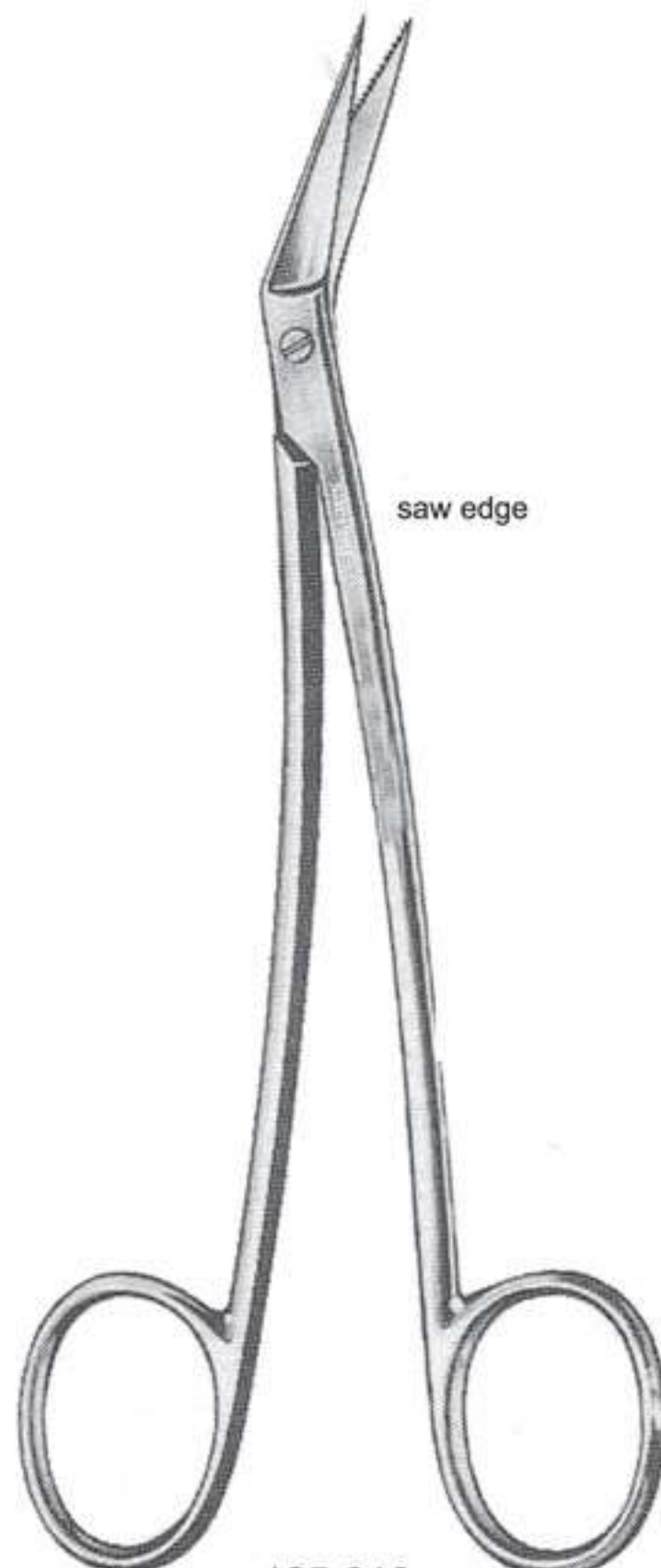

saw edge

125-016  
Fig.1  
Locklin  
16,5 cm

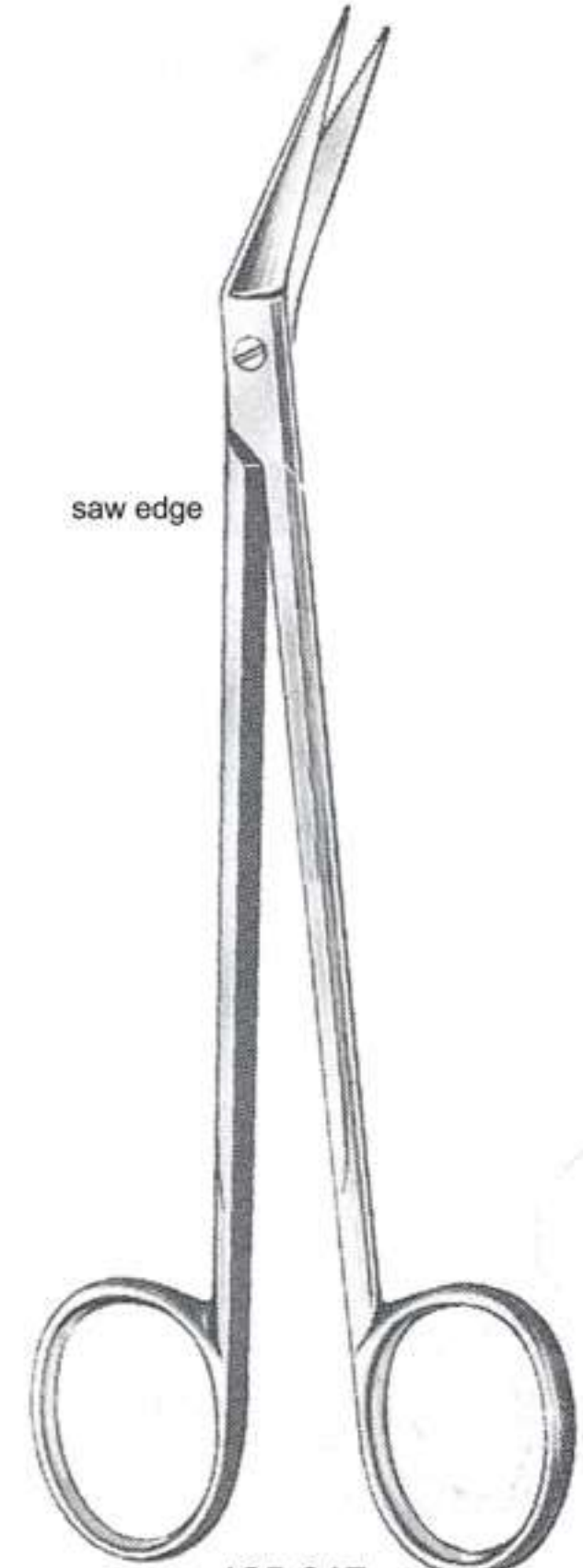

saw edge

125-017  
Fig.2  
Locklin  
16,5 cm









125-018  
Fig.1  
Noyes (Castroviejo)  
12 cm

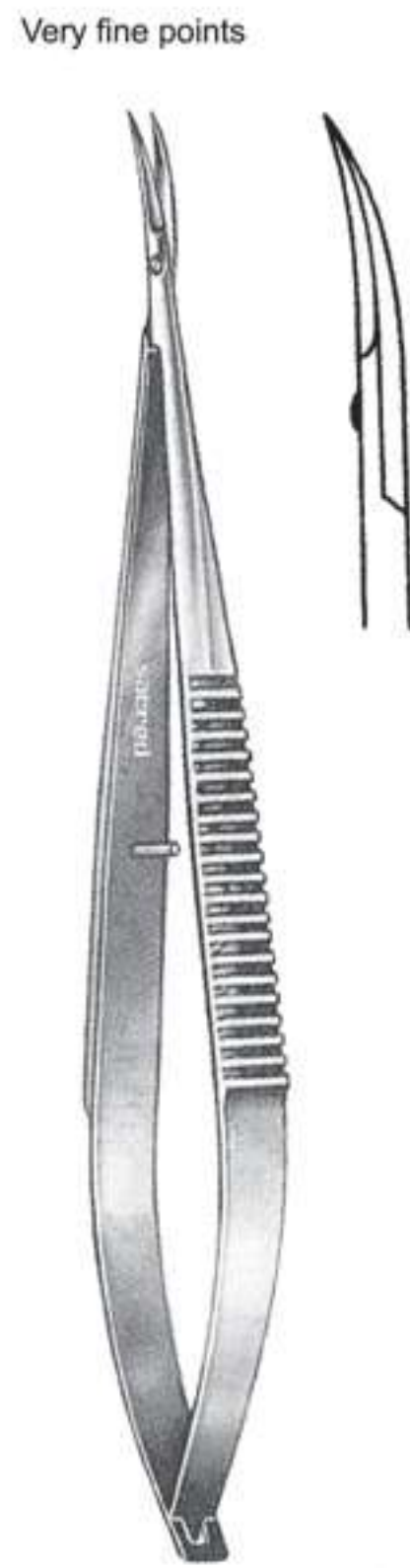

125-019  
Fig.1  
14,5 cm

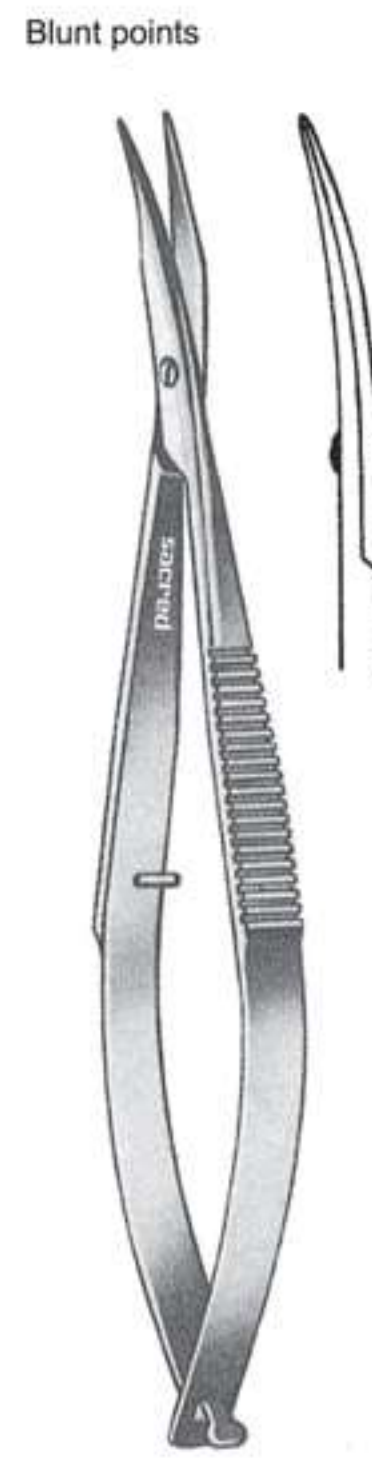

125-020  
Fig.1  
Westcott  
11 cm

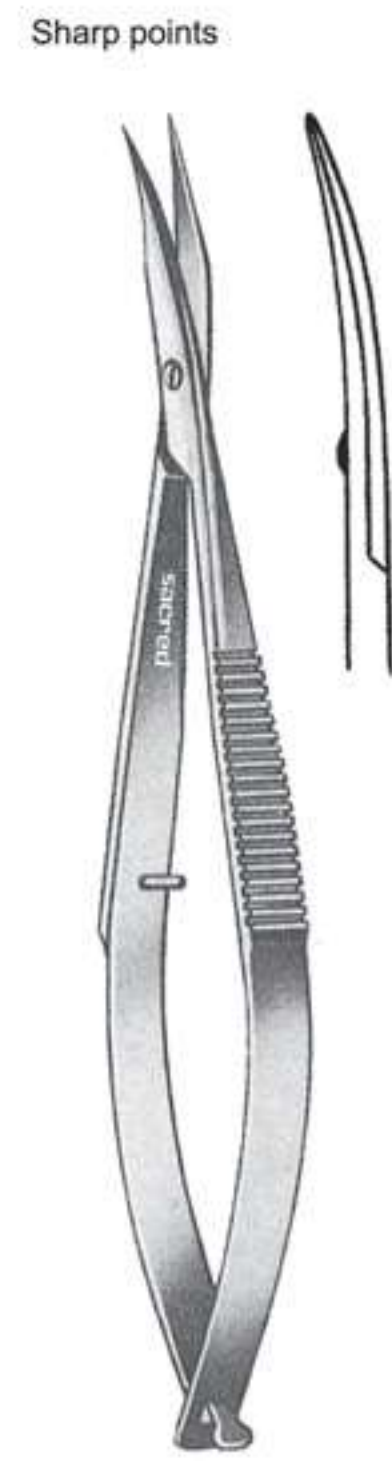

125-021  
Fig.2  
Westcott  
11 cm

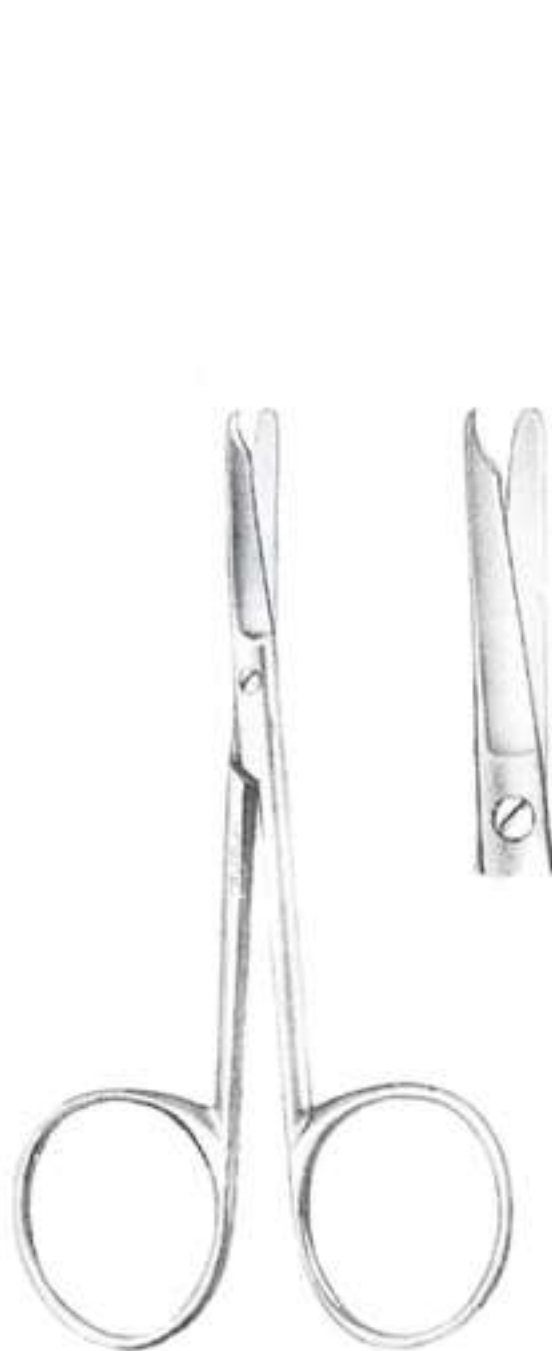

125-022  
Fig.1  
Spencer  
9 cm



125-023  
Fig.2  
Spencer  
13 cm

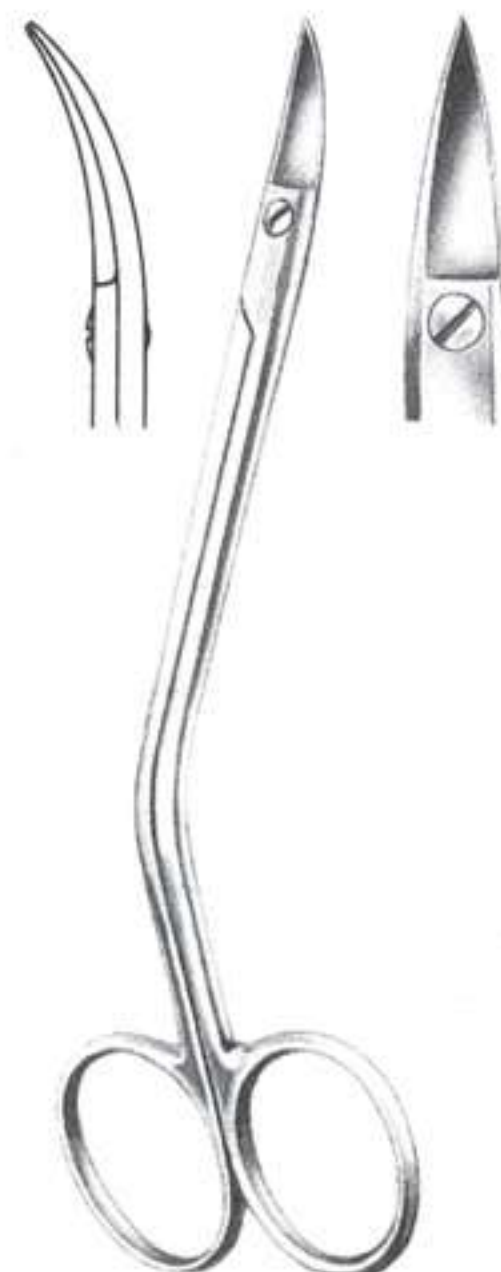

125-024  
Fig.1  
Neumann  
12,5 cm

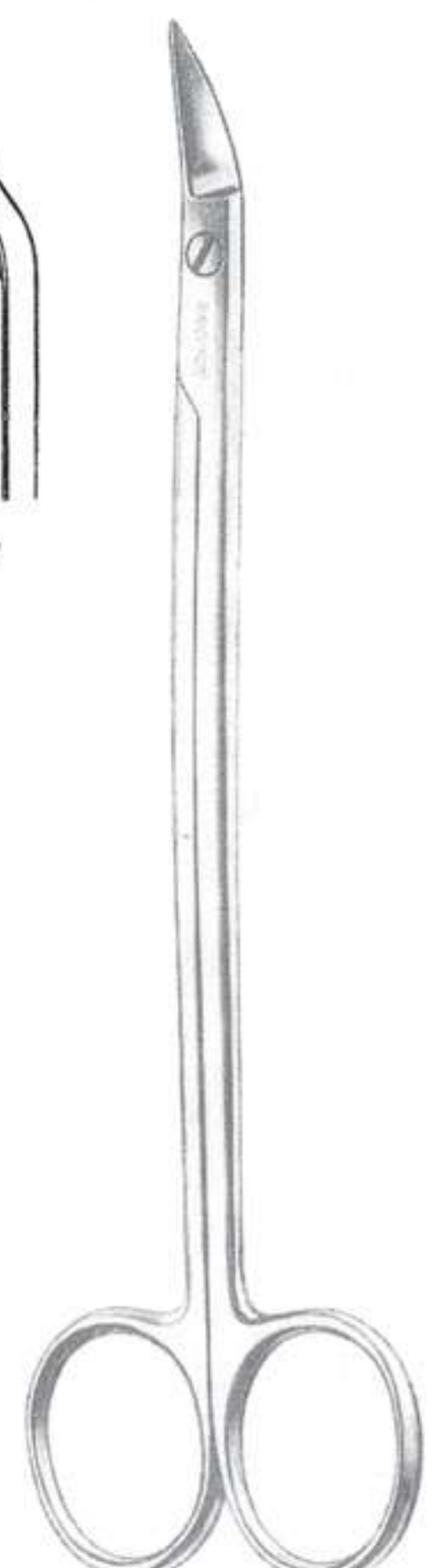
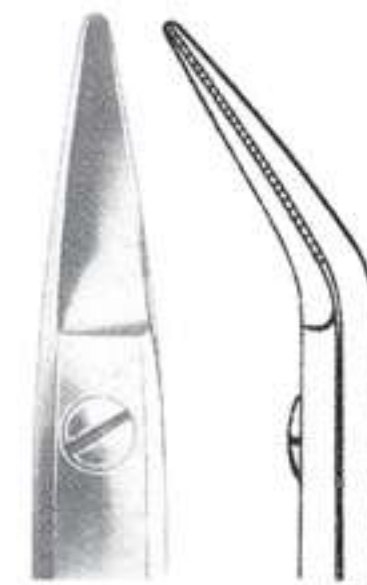

125-025  
Fig.1  
Dean  
17 cm





Straight

125-026  
Fig.1  
Mayo  
14,5 cm

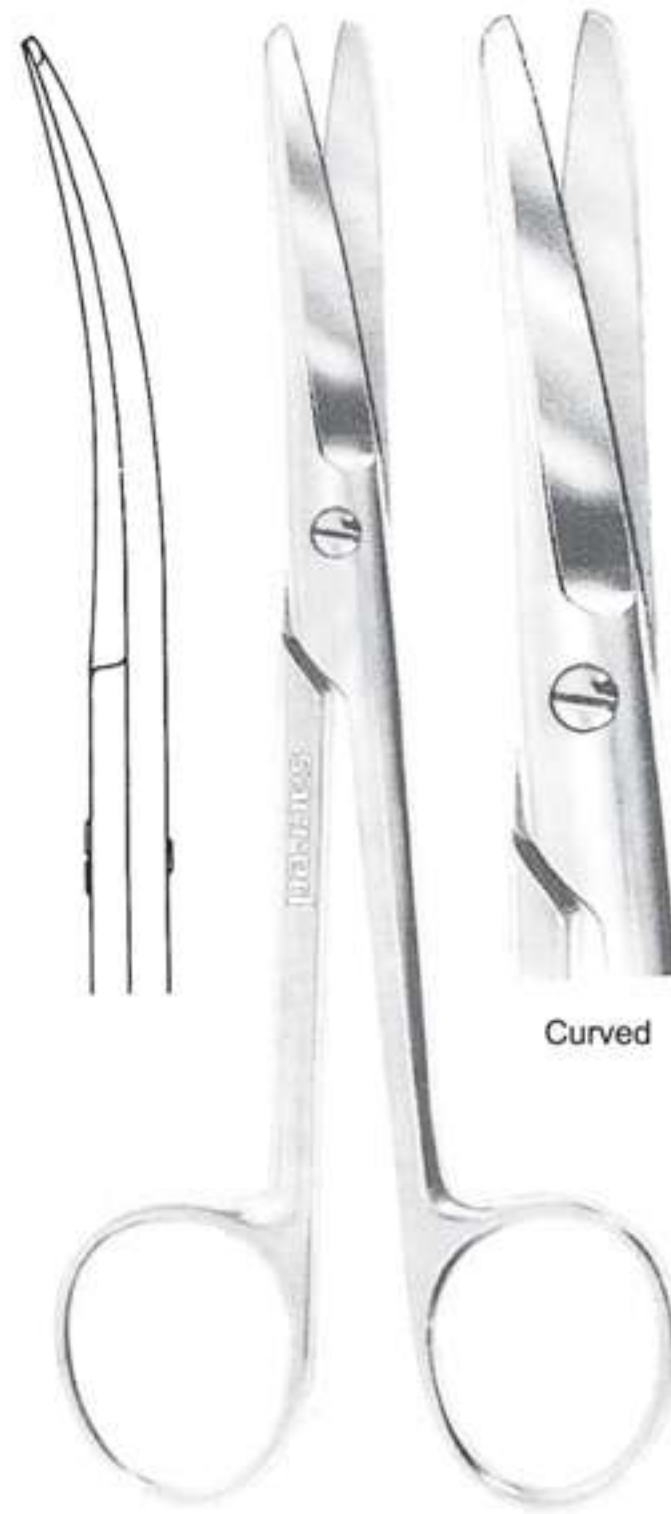

Curved

125-027  
Fig.2  
Mayo  
14,5 cm



Straight

125-028  
Fig.1  
Metzenbaum  
14,5 cm

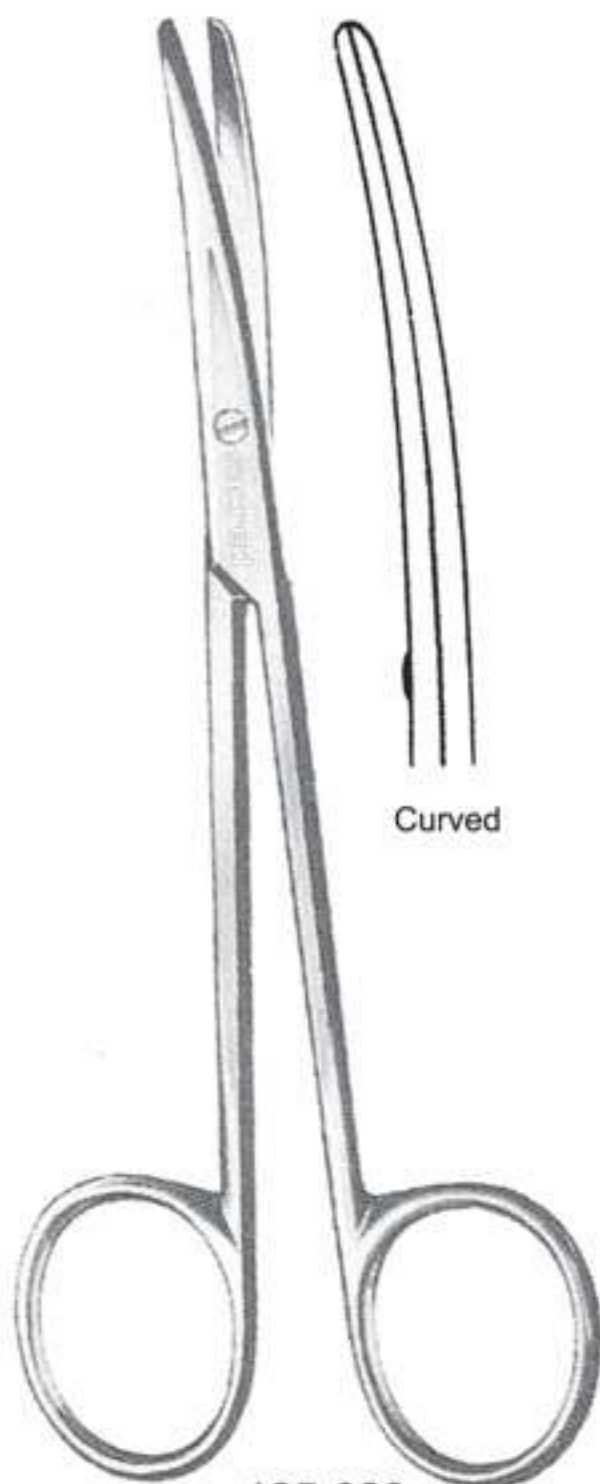

Curved

125-029  
Fig.2  
Metzenbaum  
14,5 cm



Straight

125-030  
Fig.1  
Metzenbaum-Delicate  
14,5 cm

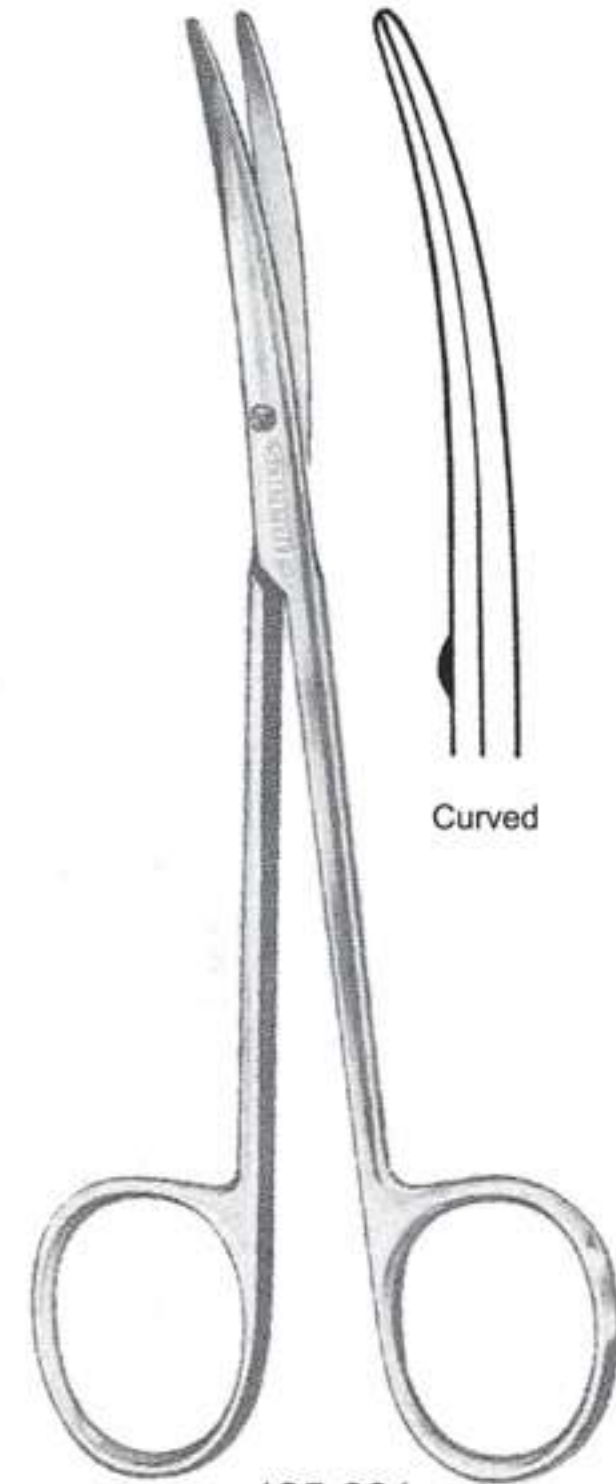

Curved

125-031  
Fig.2  
Metzenbaum-Delicate  
14,5 cm



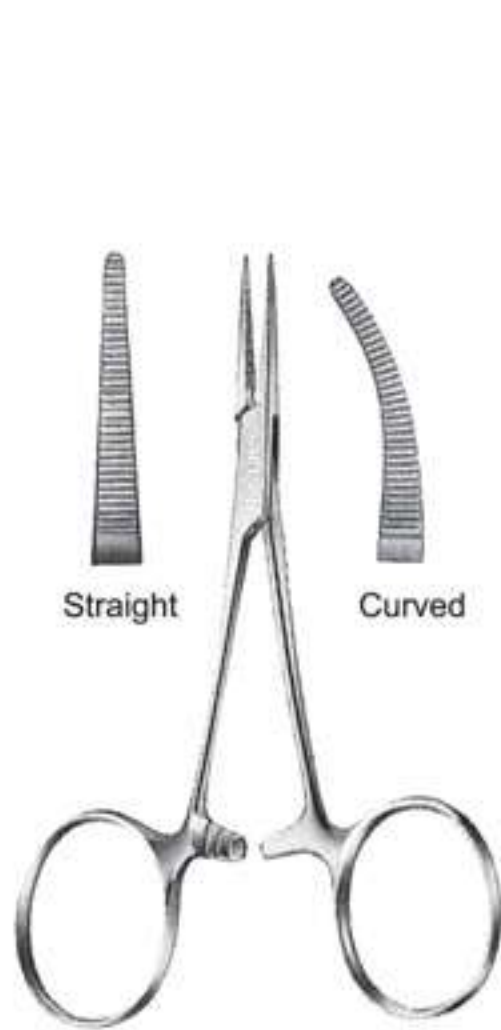

150-001  
Baby-Mosquito  
10 cm

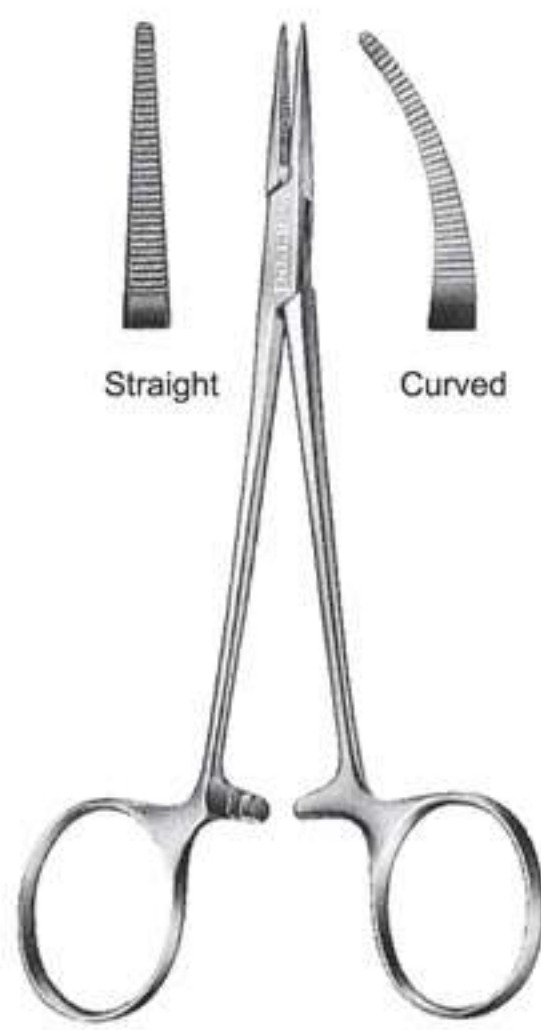

150-002  
Micro-Halsted  
12,5 cm

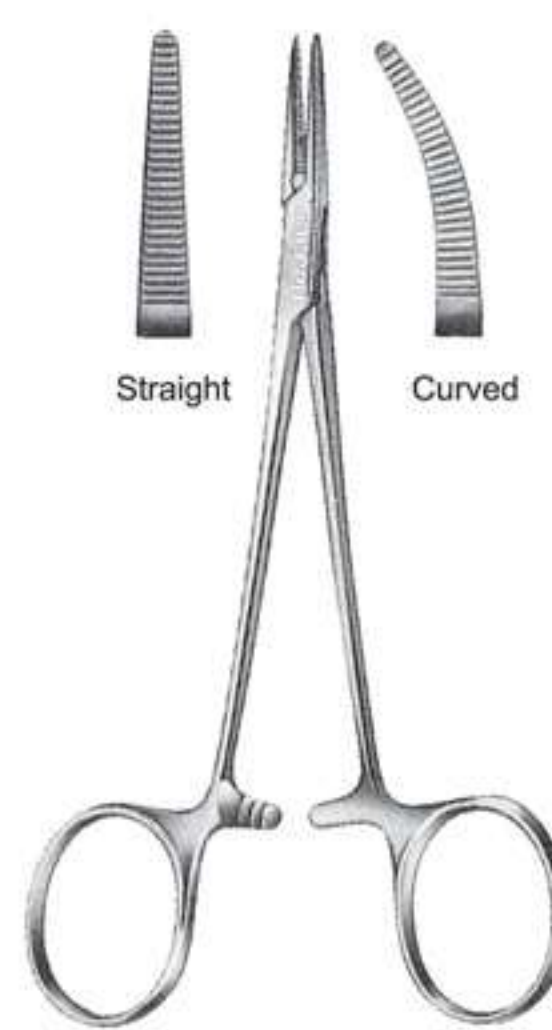

150-003  
Halsted-Mosquito  
12,5 cm

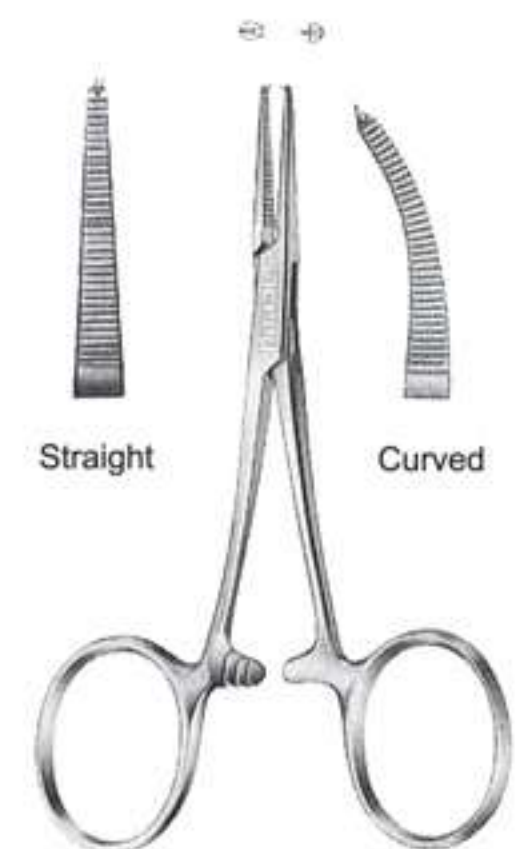

150-004  
Baby-Mosquito  
10 cm

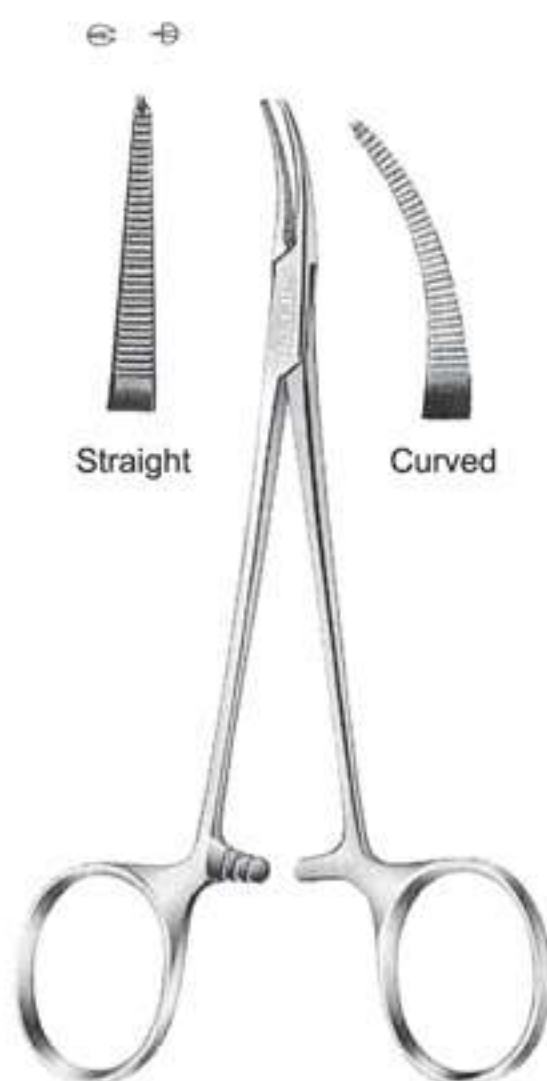

150-005  
Micro-Halsted  
12,5 cm

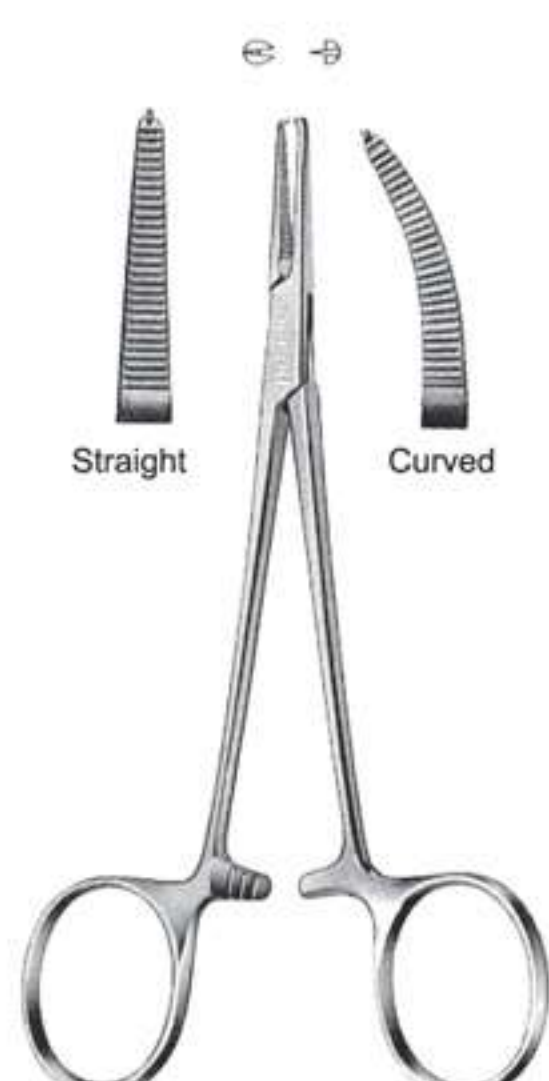

150-006  
Halsted-Mosquito  
12,5 cm



150-007  
Pean  
12,5 cm, 5"

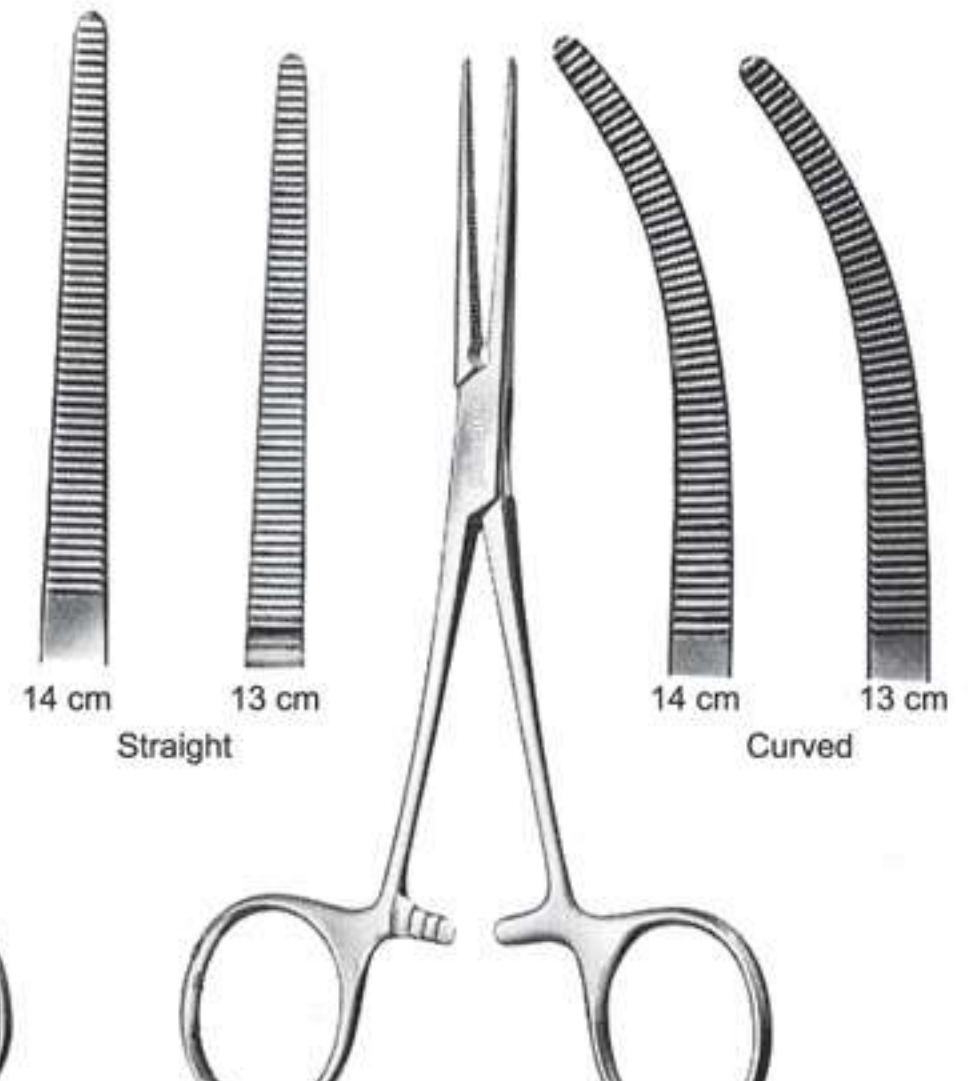

150-008  
Pean  
13 cm



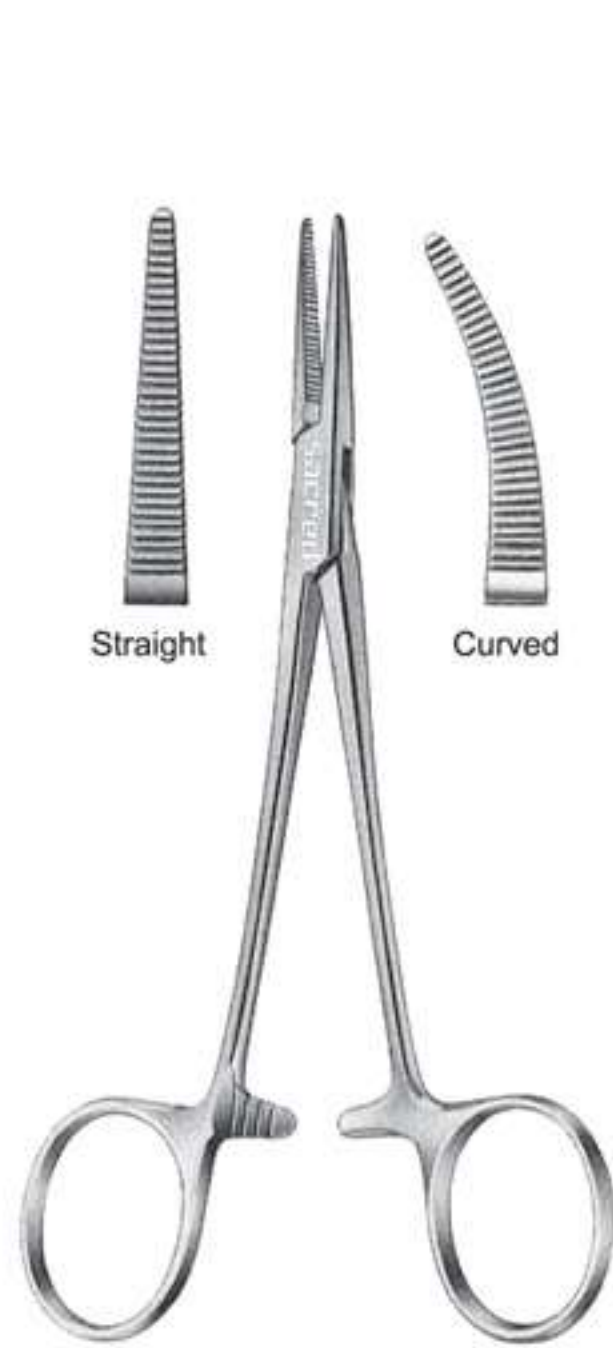

Straight Curved

150-009  
Baby-Crile (Pean)  
14 cm

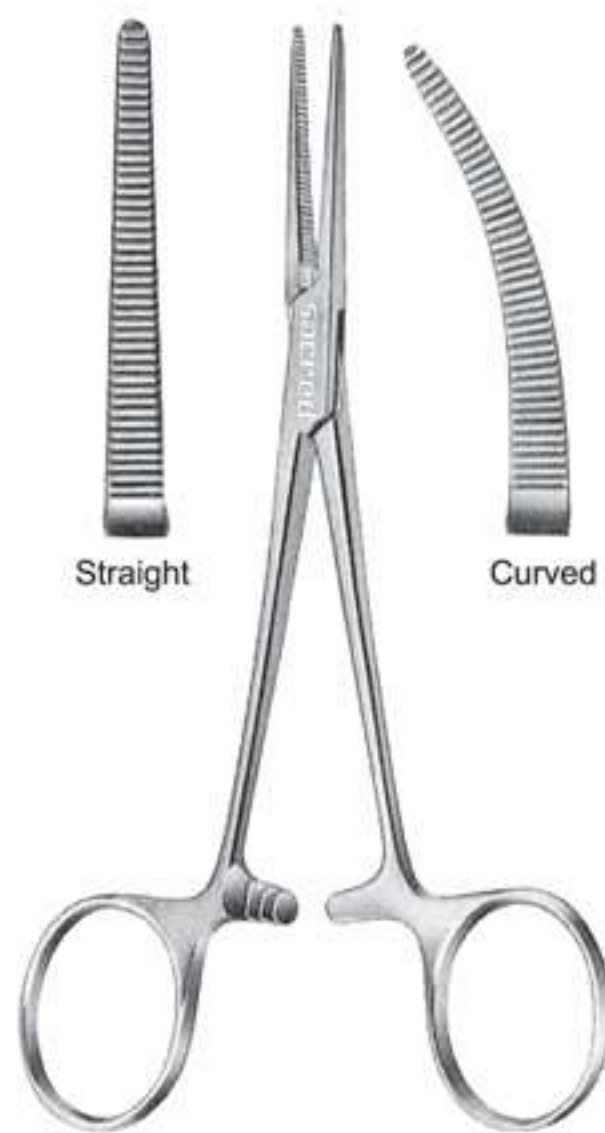

Straight Curved

150-010  
Crile  
14 cm

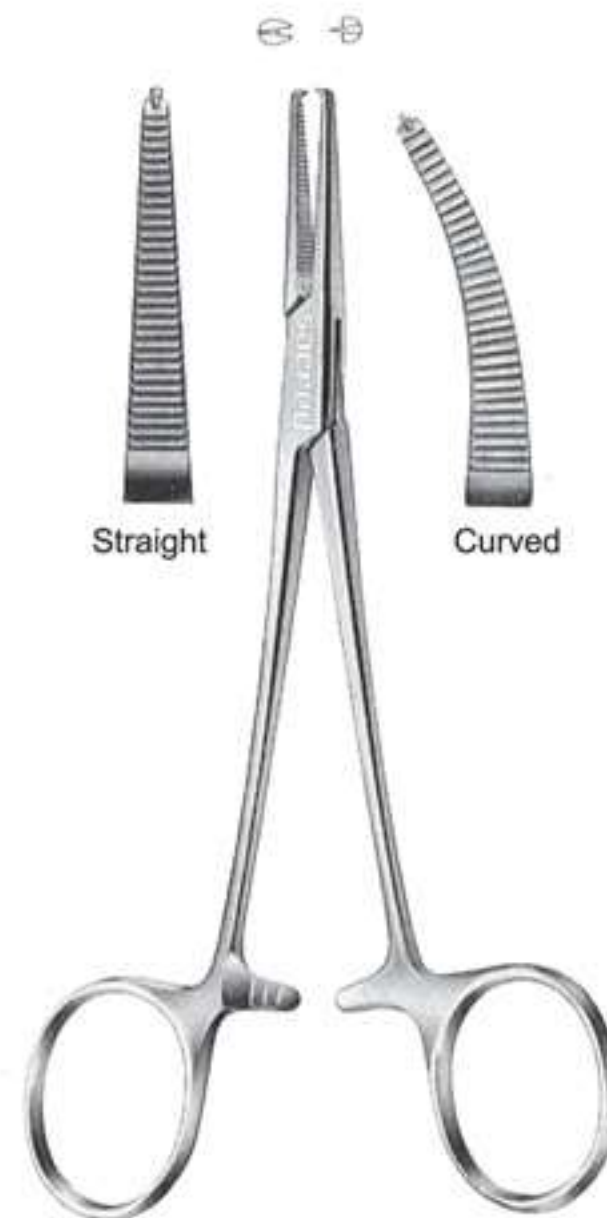

Straight Curved

150-011  
Baby-Crile(Kocher)  
14 cm

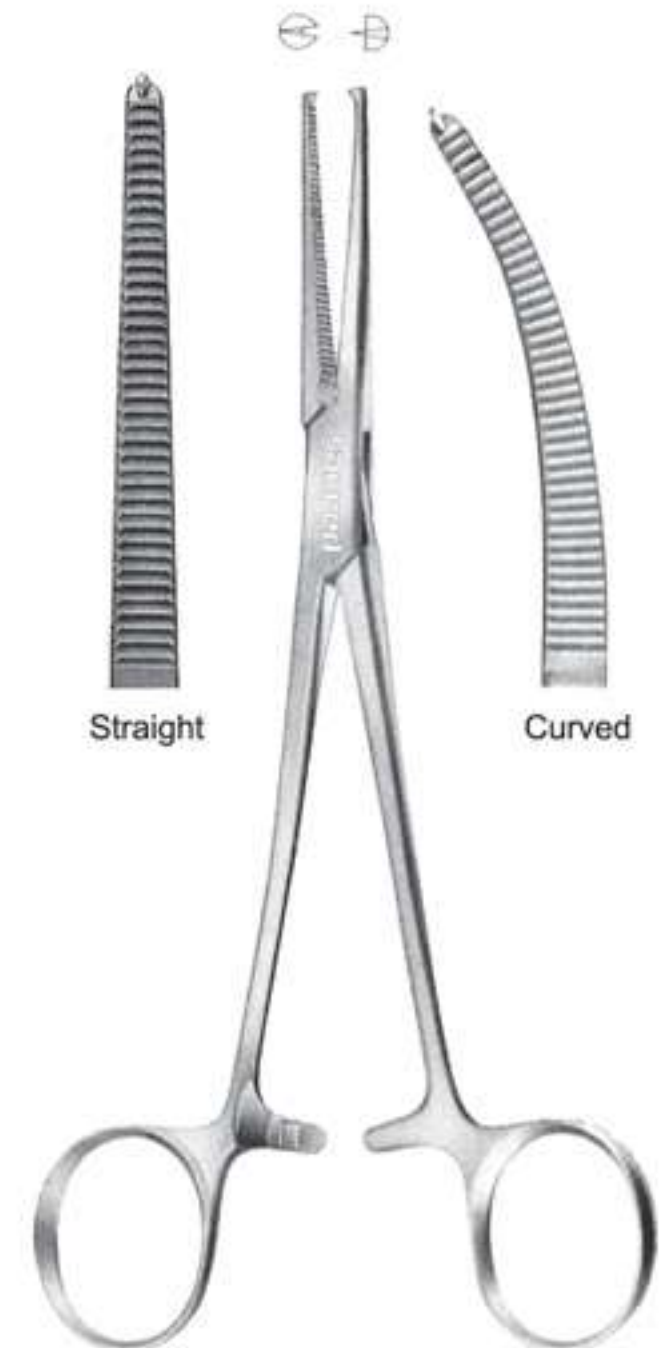

Straight Curved

150-012  
Crile(Kocher)  
16 cm

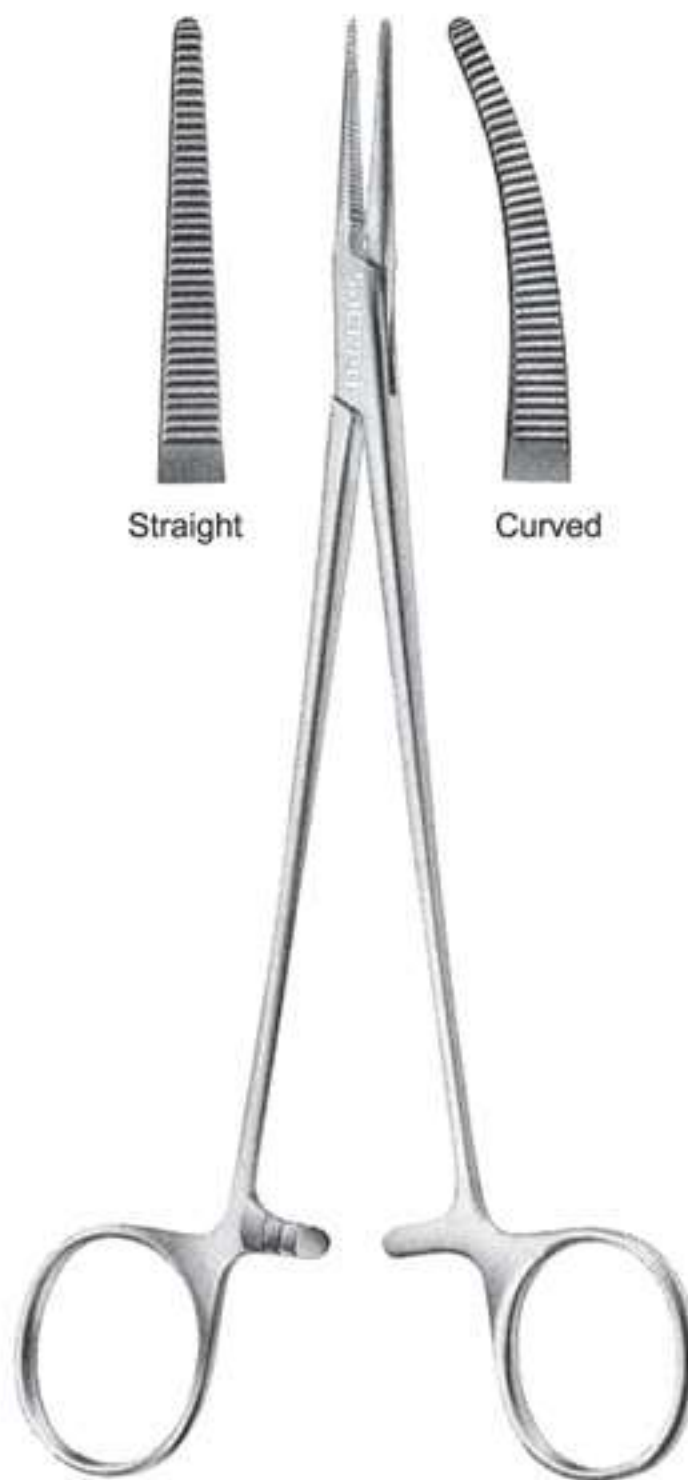

Straight Curved

150-013  
Halsted  
18,5 cm,

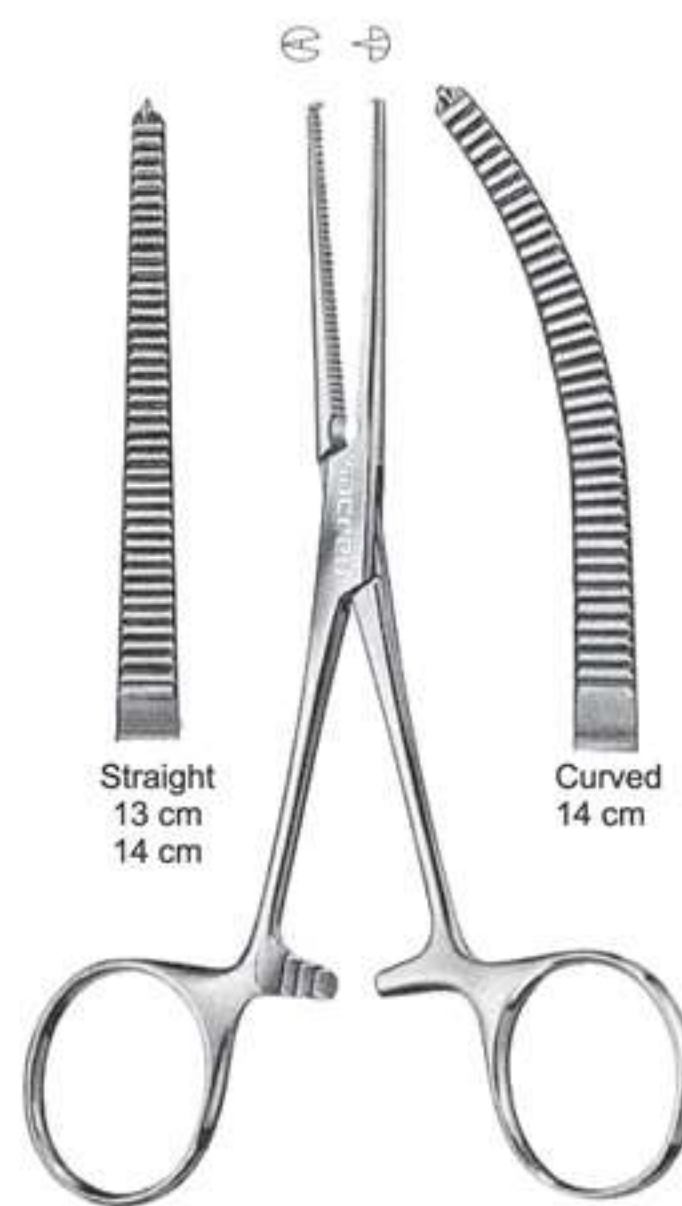

Straight 13 cm  
14 cm Curved

150-014  
Kocher

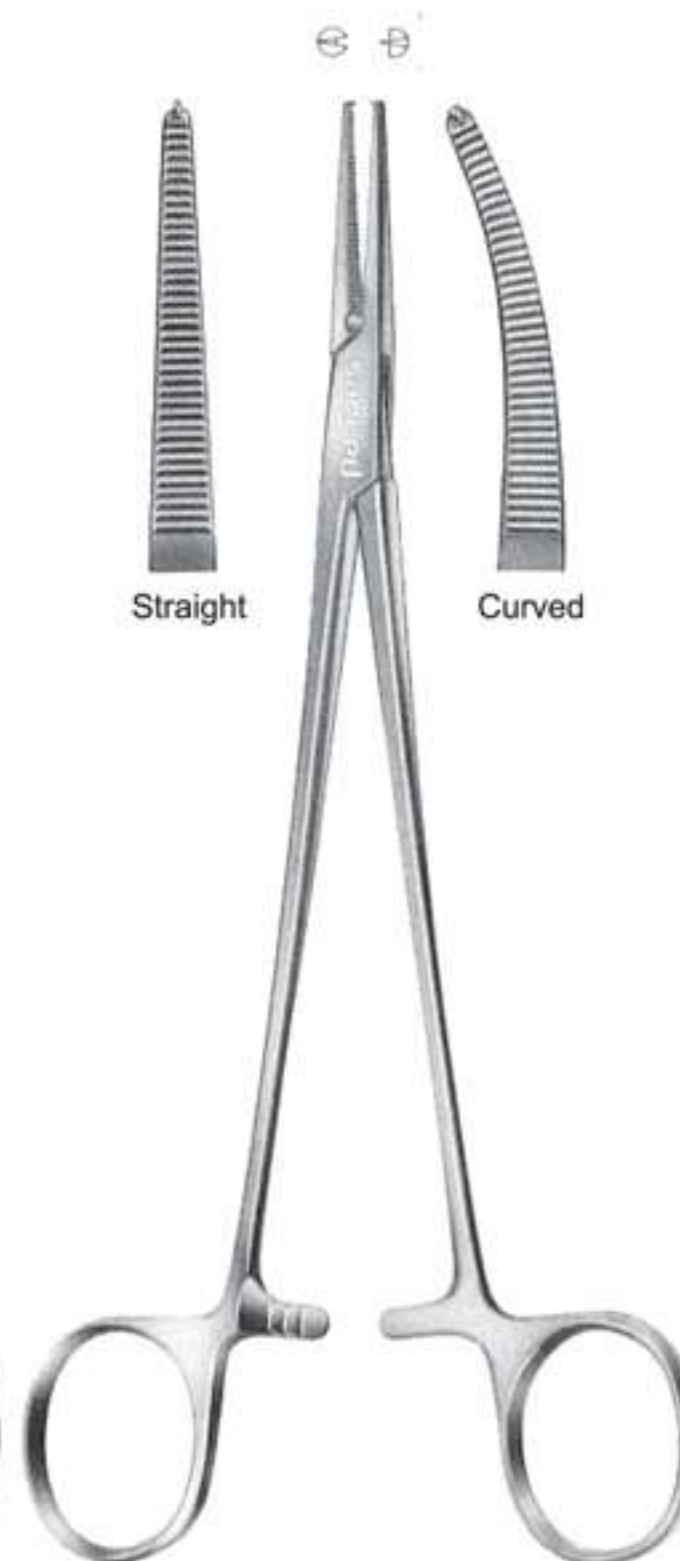

Straight Curved

150-015  
Halsted  
18,5 cm

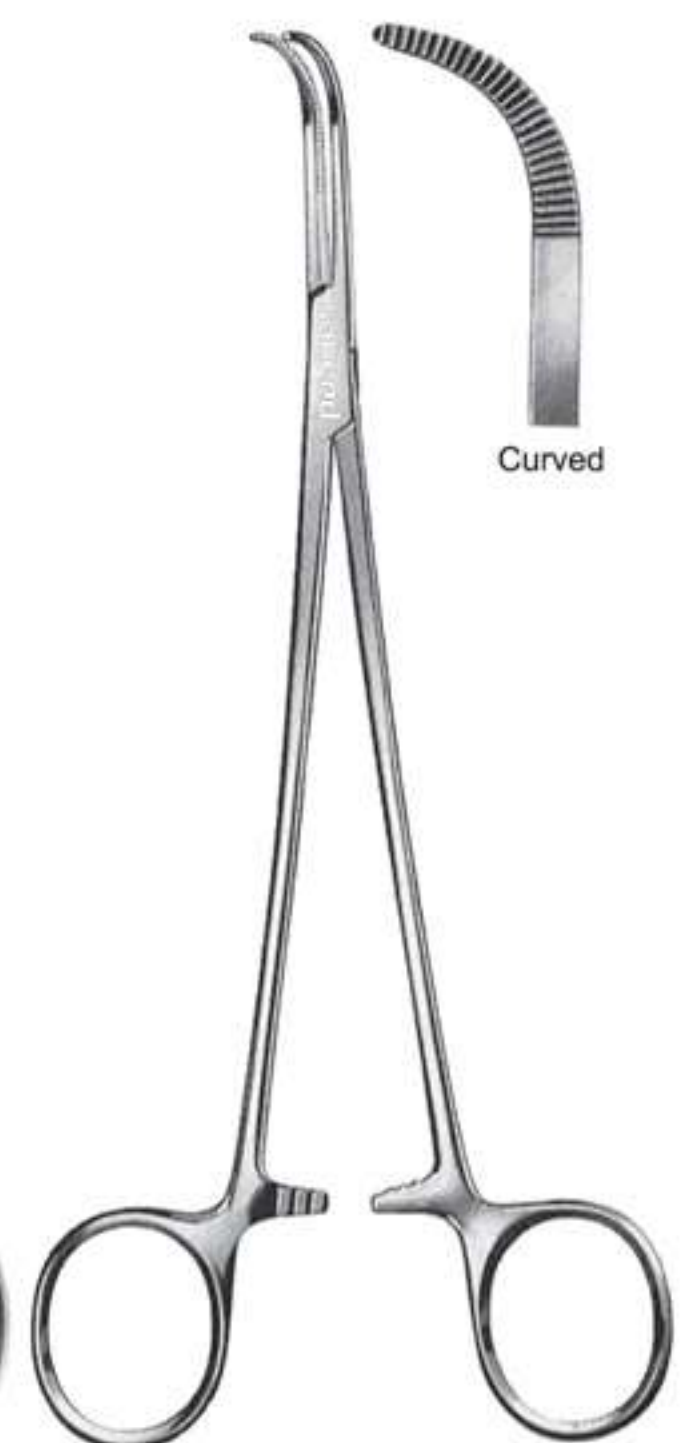

Curved

150-016  
Baby-Mixter  
18 cm





150-017  
Without Ratchet  
14,5 cm



150-018  
With Ratchet  
14,5 cm



150-019  
Curved  
17,5 cm'



150-020  
Curved  
21 cm

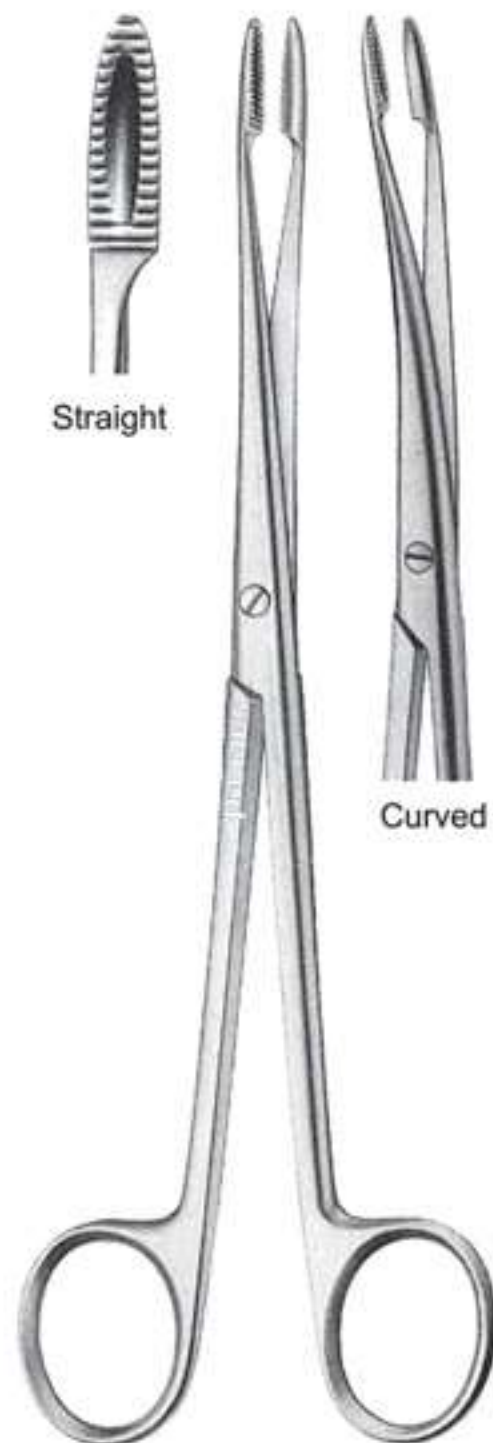
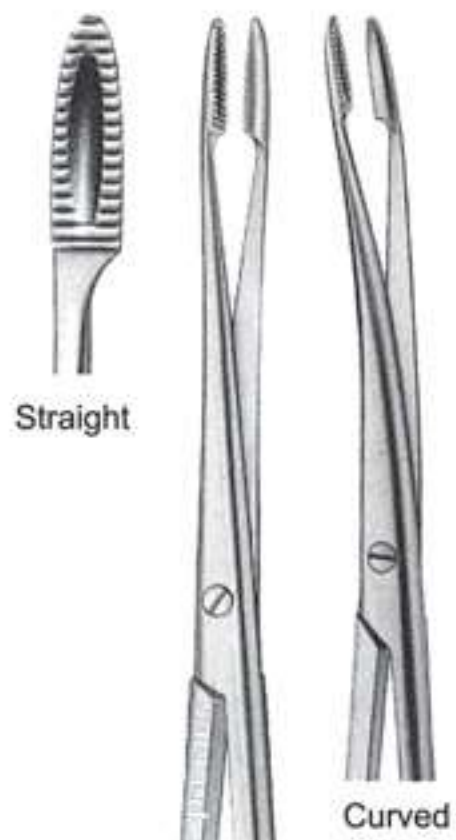

150-021  
Without Ratchet  
18 cm

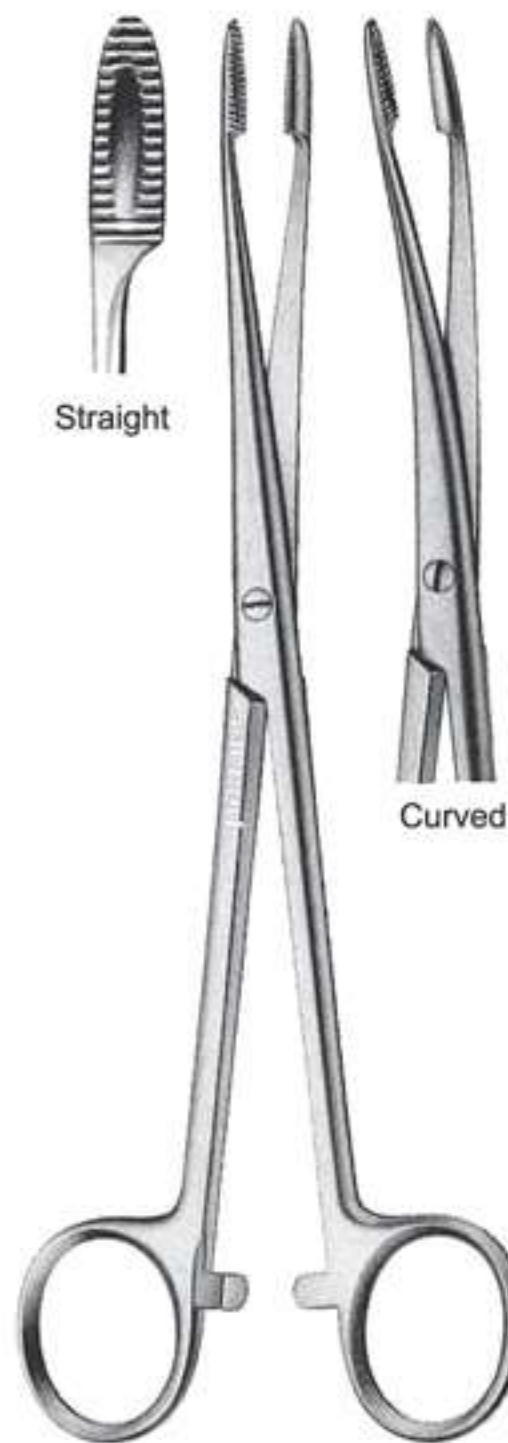
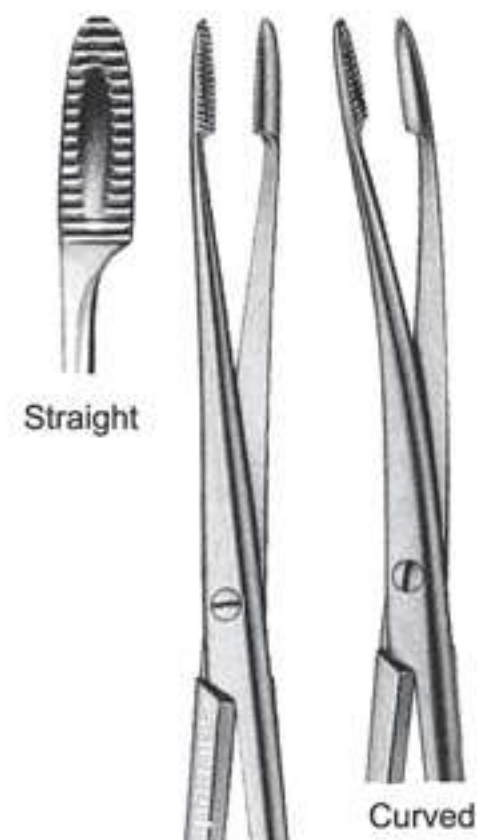

150-022  
With Ratchet  
18 cm

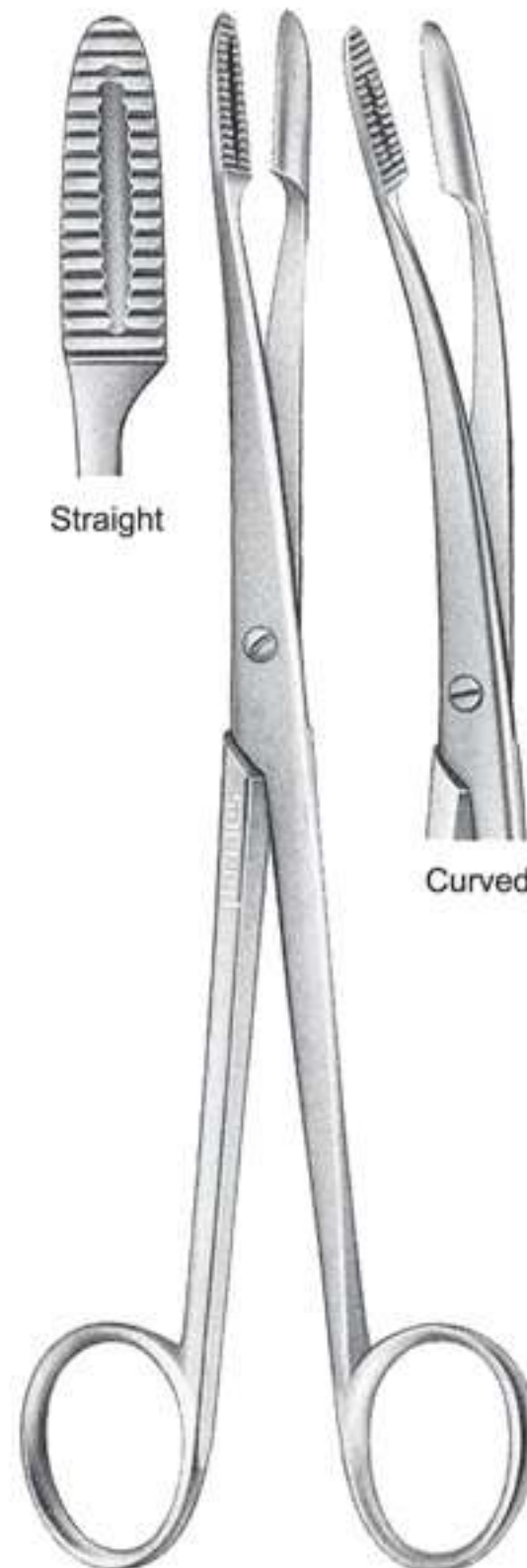
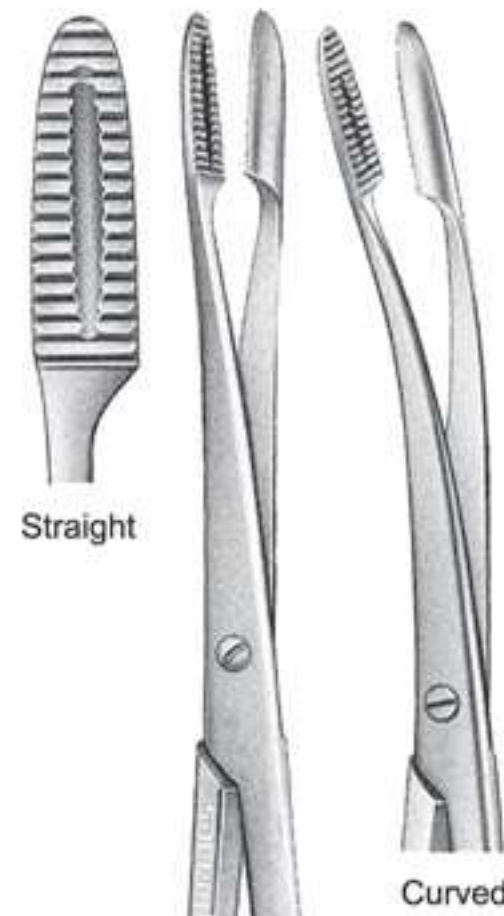

150-023  
Without Ratchet  
20 cm

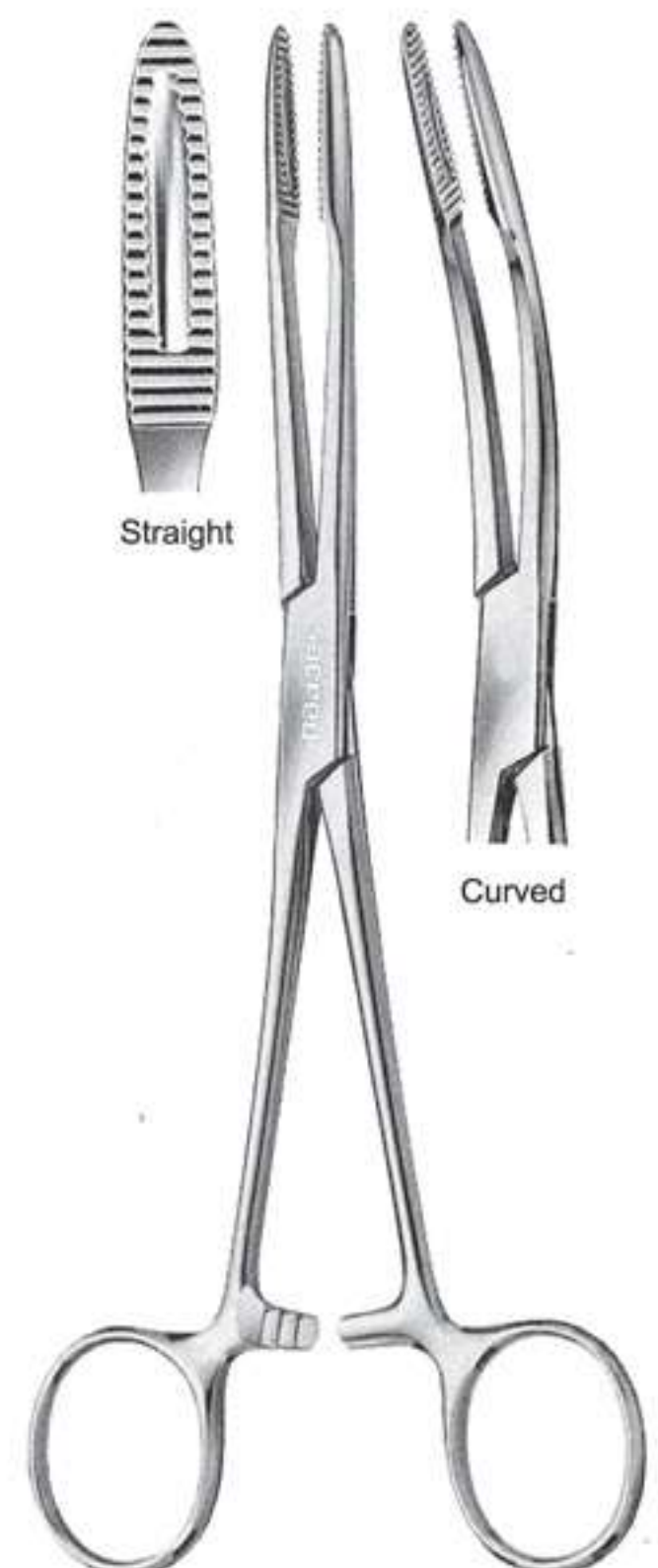
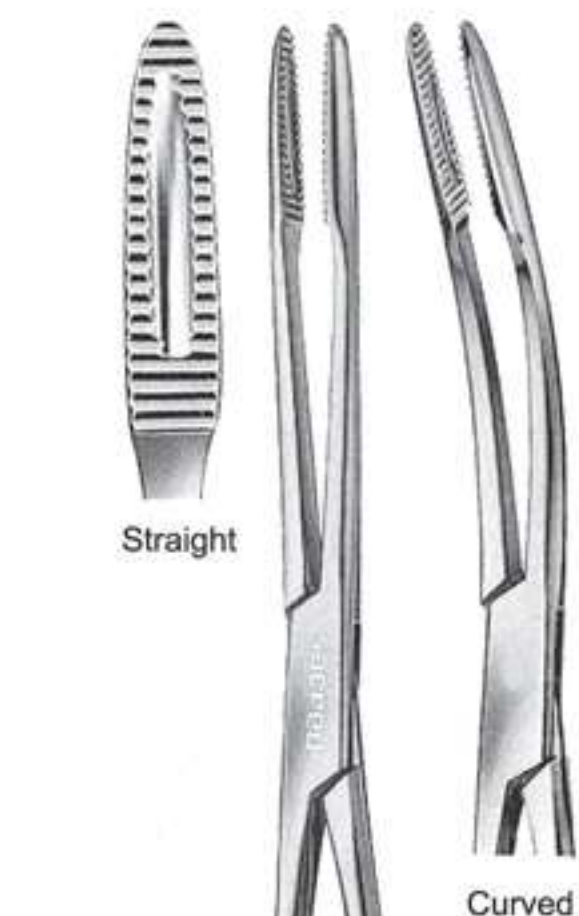

150-024  
With Ratchet  
20 cm





Designed for Frontal & Palate Suture



Needle holders with Scissors

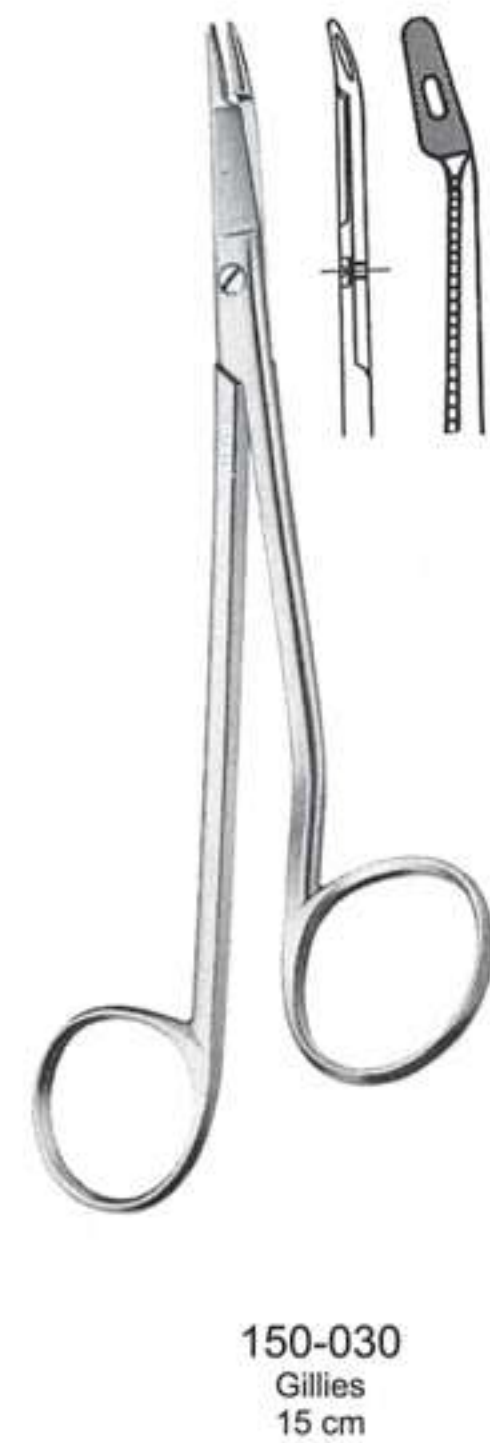





150-031  
Mathieu  
14 cm,



150-032  
Mathieu  
14 cm,



150-033  
Boynton  
12 cm,



150-034  
Castroviejo  
14 cm,



150-035  
Castroviejo  
14 cm,



Curved, Straight,

150-036  
Castroviejo  
13 cm,

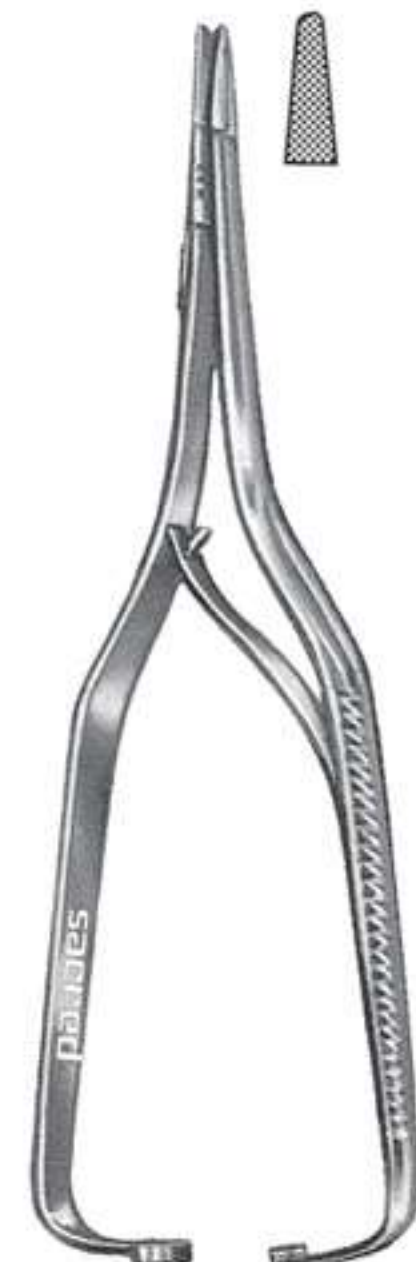

150-037  
Arruga  
16 cm,





150-038  
Backhaus

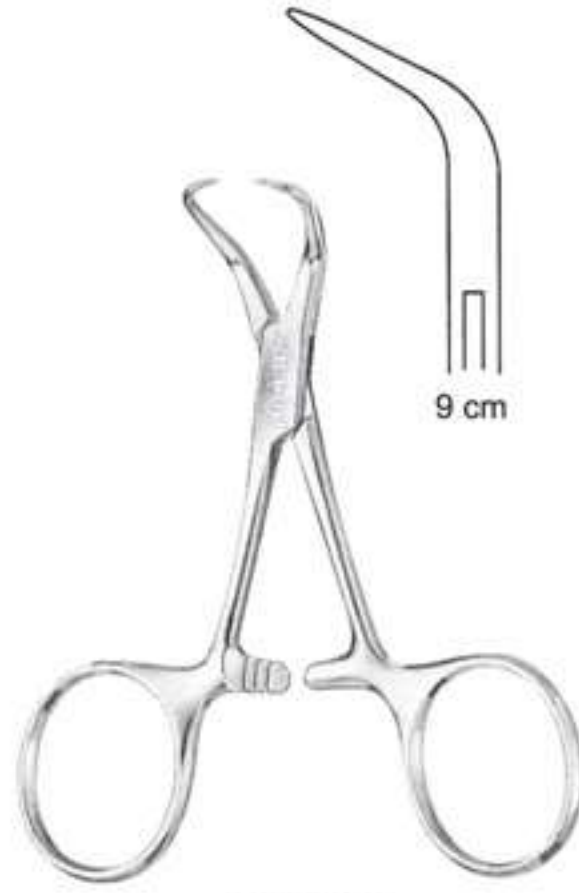

150-039  
Backhaus

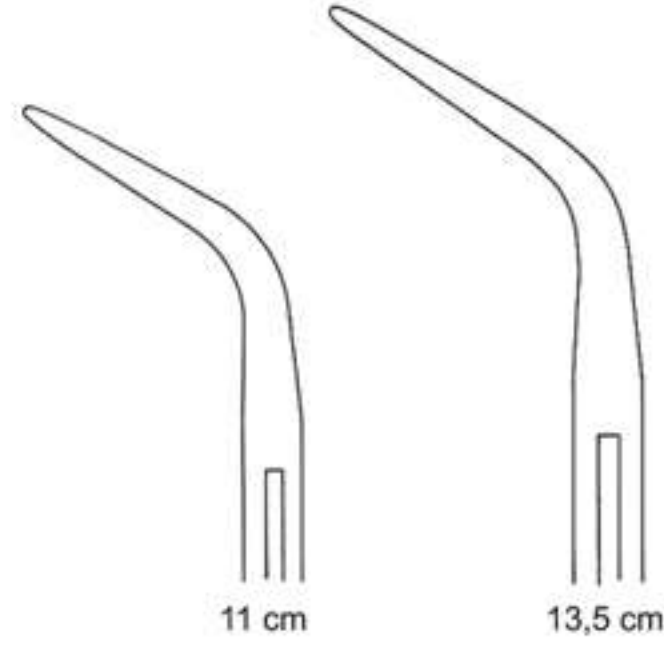

150-040  
Backhaus-Kocher  
13.5 cm



150-041  
16 cm

150-042  
Cheattle  
28 cm

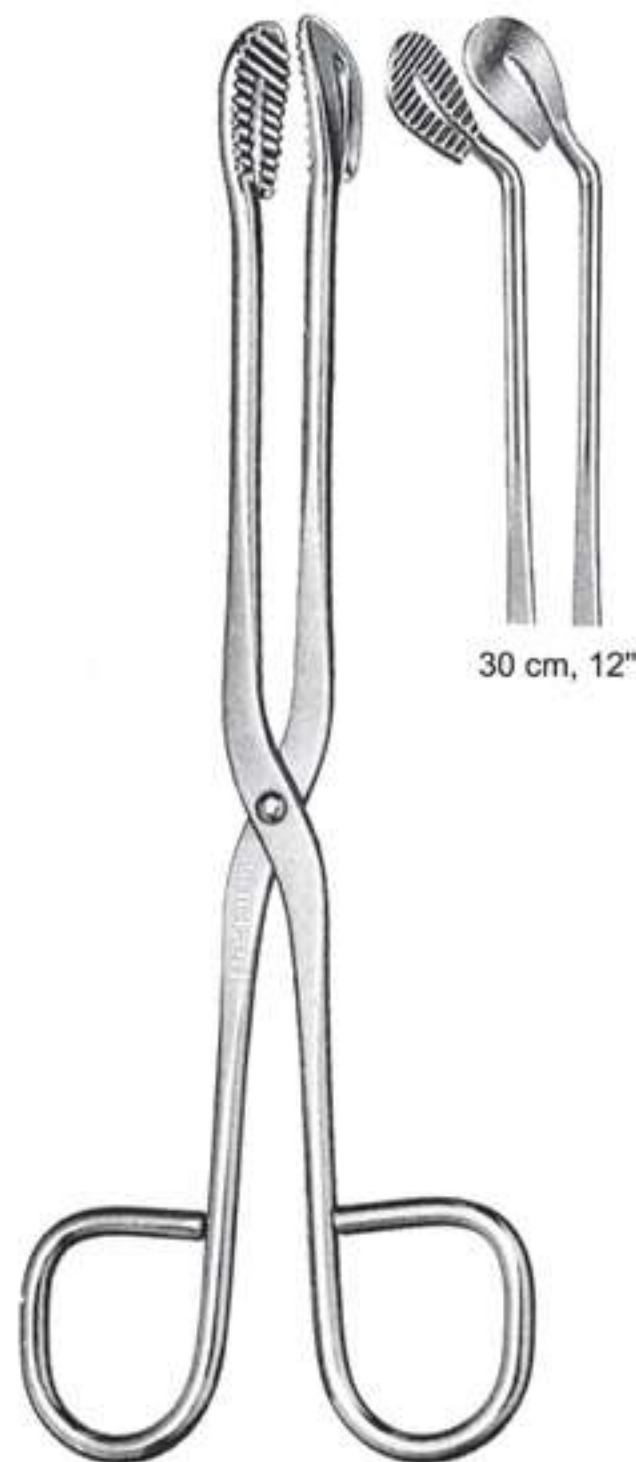

150-043  
20 cm



150-044  
20 cm, 8"  
30 cm, 12"



150-045  
Rogge  
23.5 cm



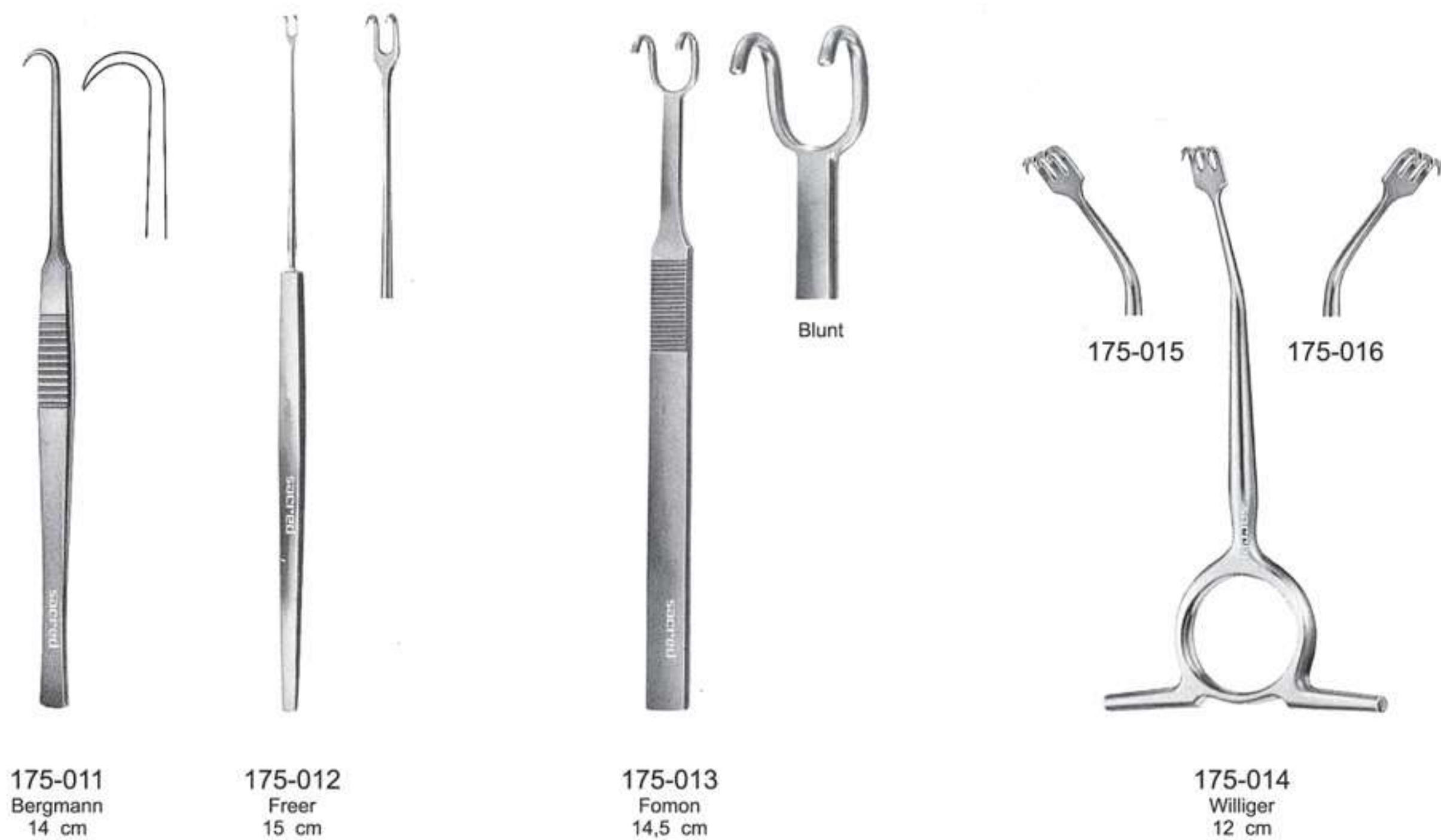
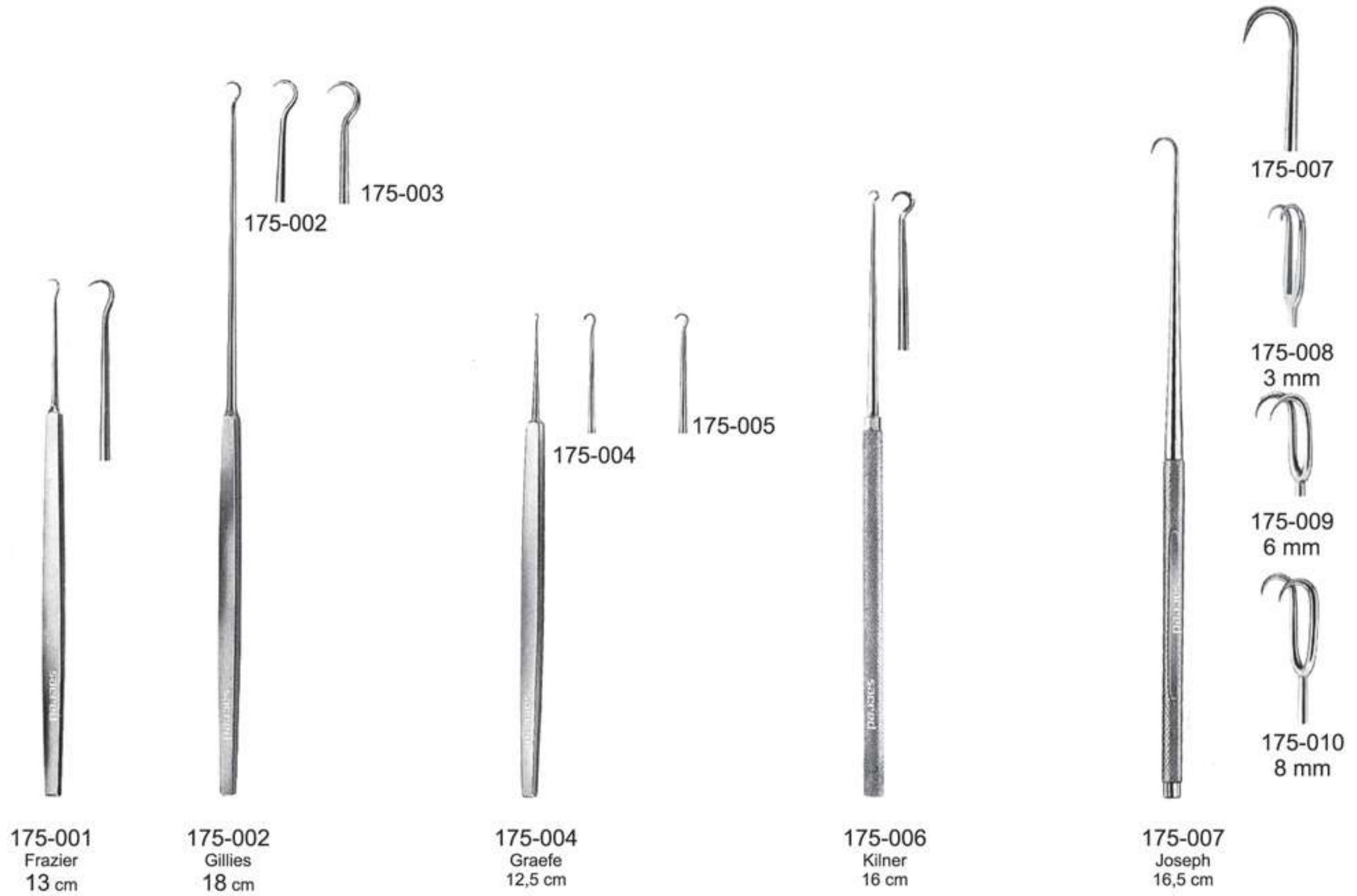



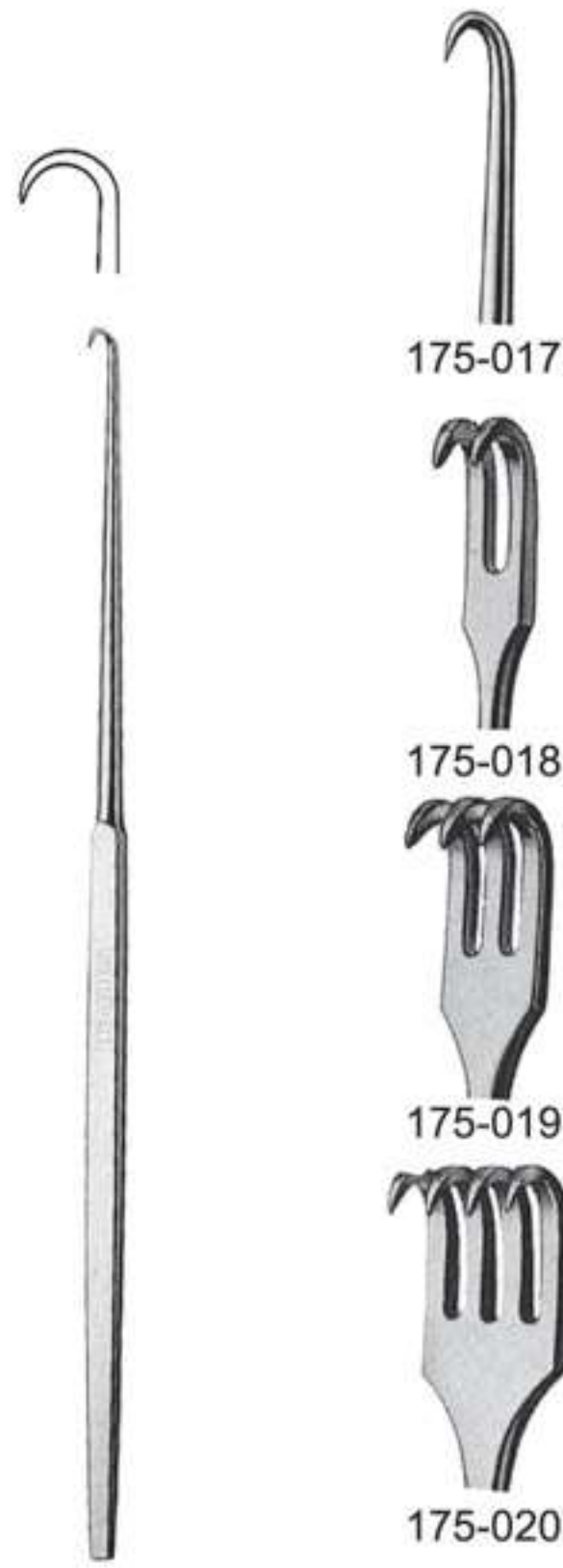

**175-017**  
Small Curve, Sharp  
16,5 cm

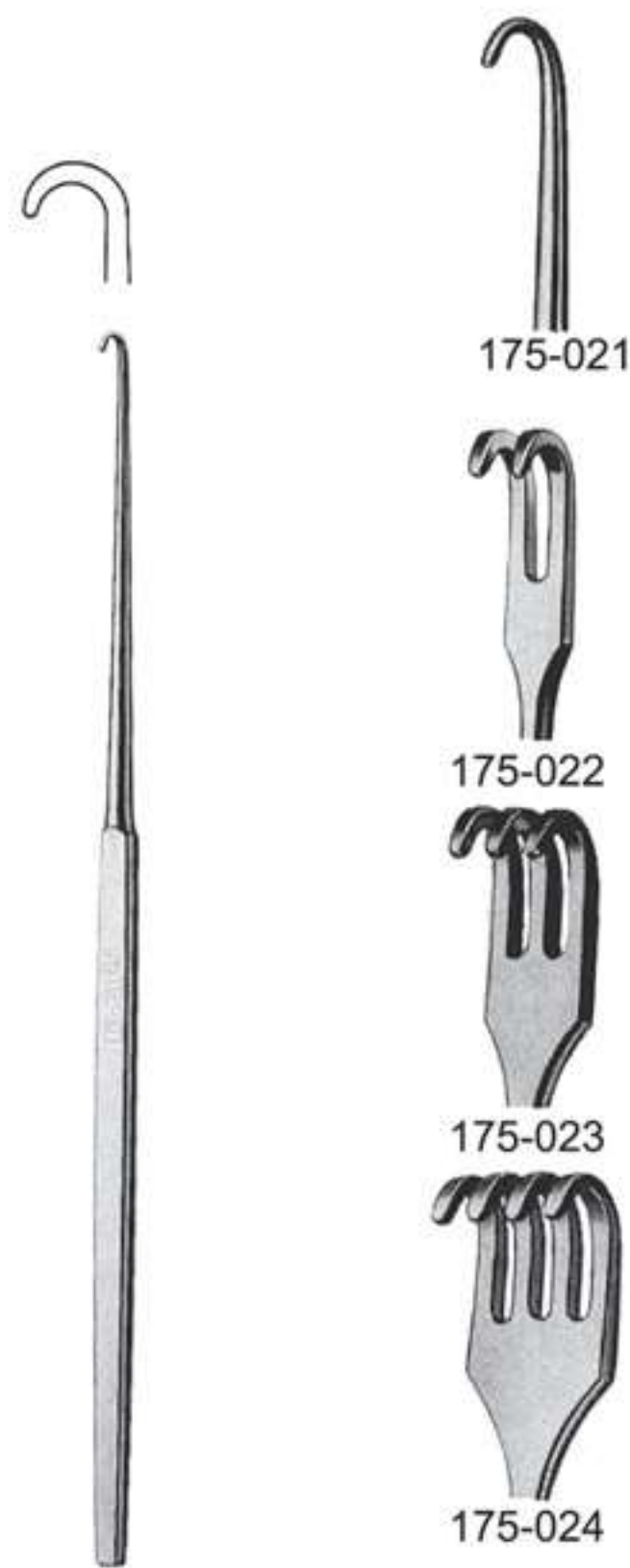

**175-021**  
Small Curve, Blunt  
16,5 cm



**175-025**  
Flexible Shaft, Sharp  
15,5 cm



**175-027**  
Strandell-Stille  
18 cm



**175-029**  
16 cm



**175-031**  
Langenbeck- Green  
16 cm



**175-033**  
16 cm





25 x 10 mm  
22 x 10 mm

28 x 12 mm  
32 x 12 mm

175-034  
Farabeuf  
12,5 cm



23 x 16 mm  
20 x 16 mm

24 x 16 mm  
28 x 16 mm

175-035  
Farabeuf  
15 cm

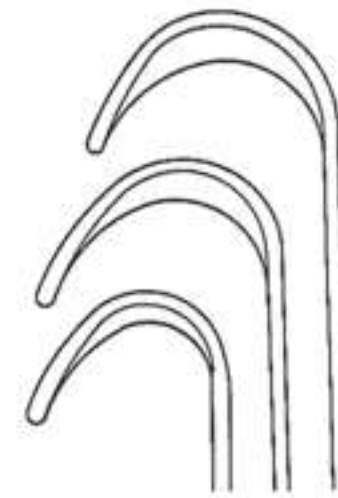

175-037  
175-038  
175-039

175-036  
Roux - Set  
16,5 cm  
Consisting of :  
175-037 19 x 22 mm  
23 x 30 mm  
175-038 25 x 26 mm  
28 x 38 mm  
175-039 28 x 29 mm  
33 x 45 mm



29 mm  
26 mm  
22 mm

28 mm  
38 mm  
45 mm



175-040  
30 x 10 mm

175-041  
40 x 10 mm

175-042  
43 x 13 mm



175-040  
Langenbeck  
23 cm



175-043  
25 x 6 mm

175-044  
35 x 8 mm

175-045  
35 x 11 mm

175-046  
35 x 15 mm

175-047  
41 x 11 mm

175-048  
55 x 11 mm



175-043  
Kocher-Langenbeck  
21,5 cm





175-049  
Middeldorpf



175-049  
15x15 mm  
22 cm



175-050  
20x22 mm  
21,5 cm



175-051  
28x28 mm  
23,5 cm



175-052  
Greene  
22,5 cm



175-053  
Buchs  
20,5 cm



175-054  
Langenbeck  
21 cm



175-054  
28x10 mm



175-055  
28x14 mm



175-056  
33x14 mm



175-057  
28x16 mm



175-058  
40x10 mm



175-059  
40x13 mm



175-060  
Kocher  
21 cm

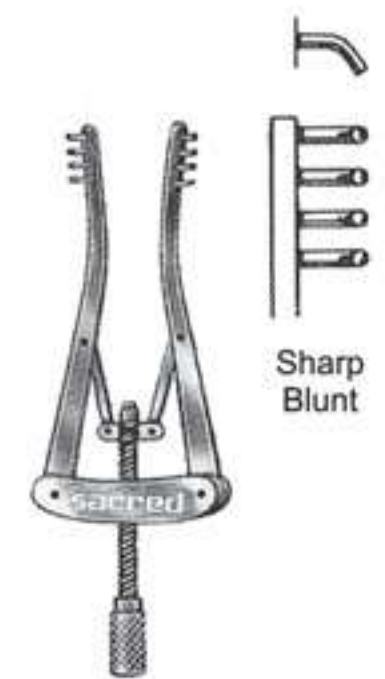

175-061  
Alm  
7 cm

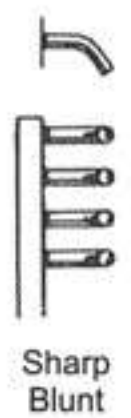

Sharp  
Blunt

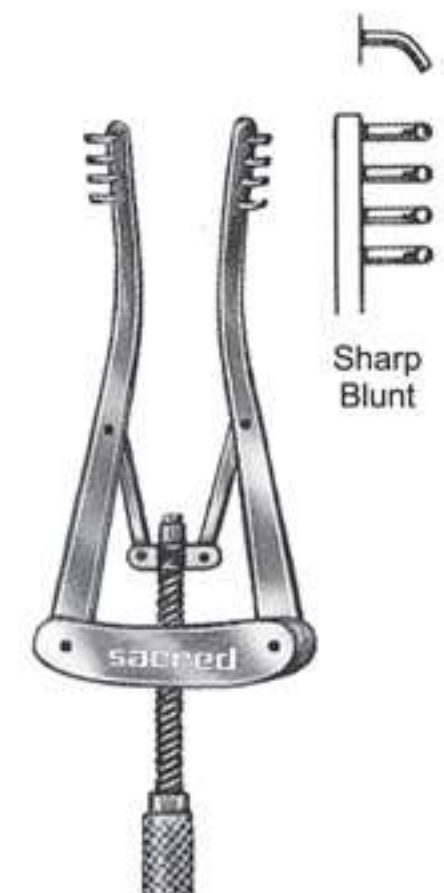

175-062  
Alm  
10 cm

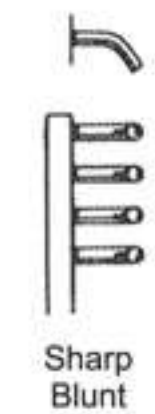

Sharp  
Blunt



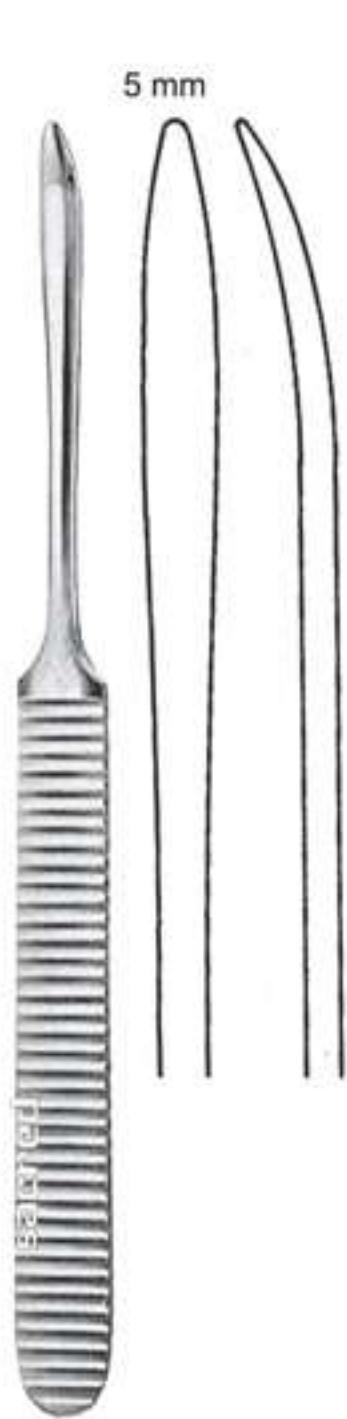

200-001  
Williger  
16,5 cm

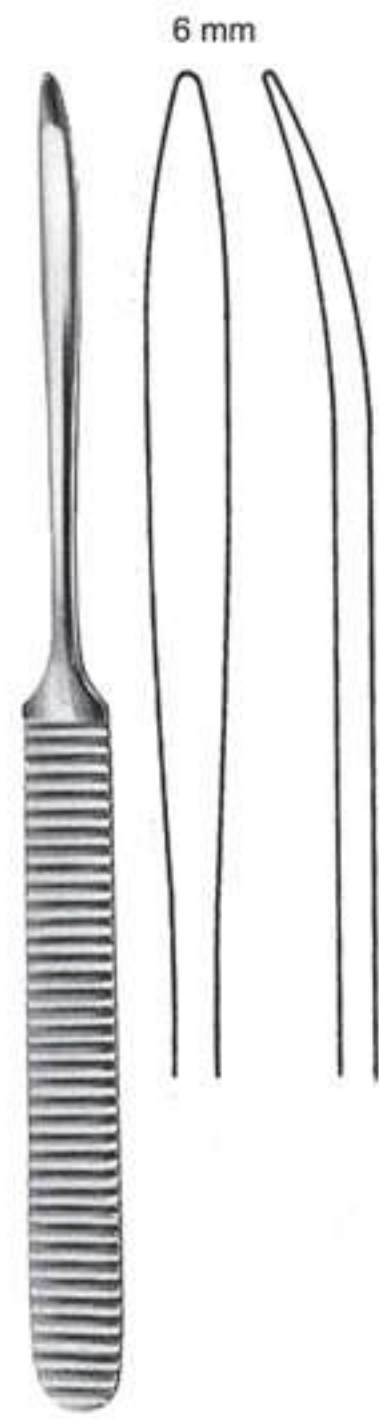

200-002  
Williger  
17 cm

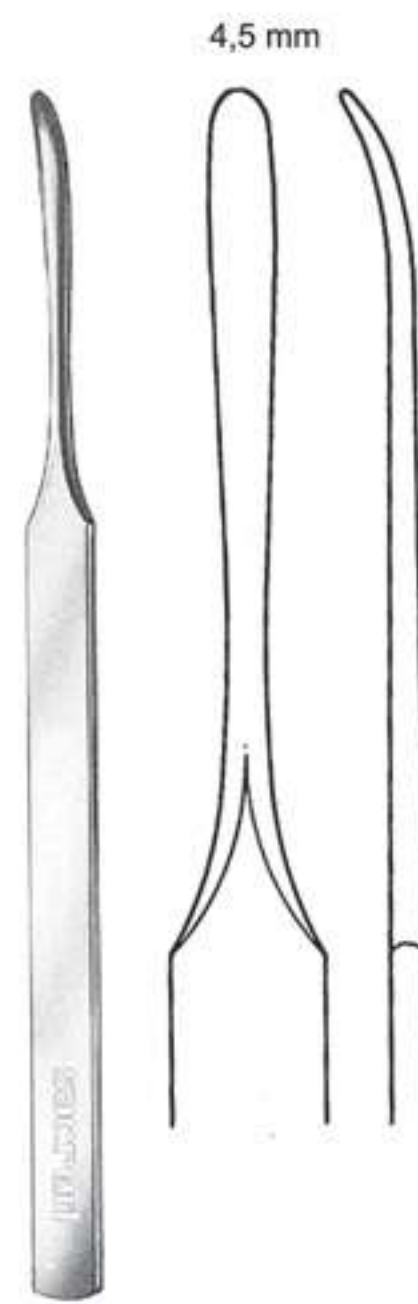

200-003  
Konig  
15,5 cm

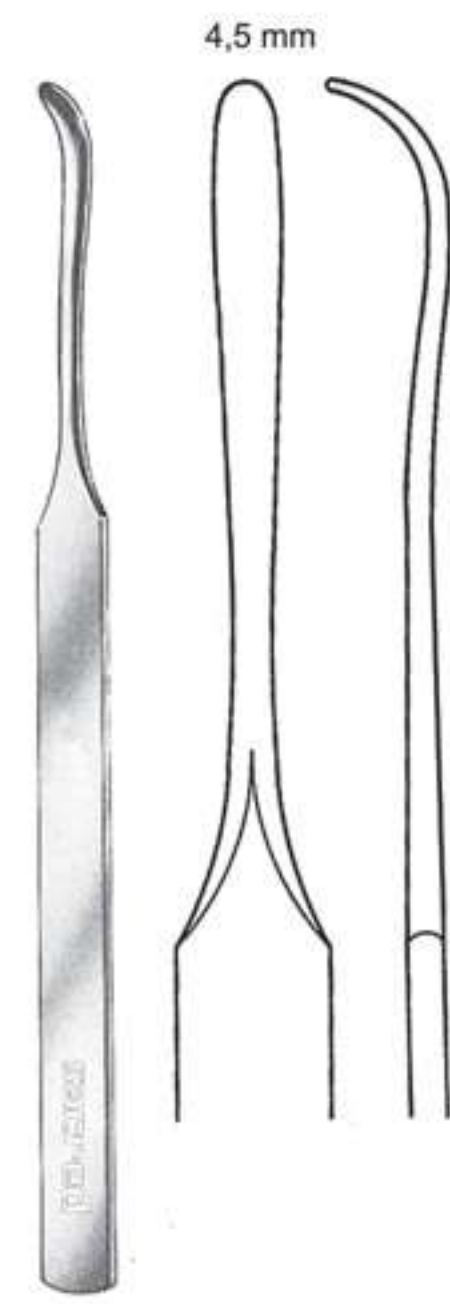

200-004  
Konig  
15,5 cm



200-005  
Freer  
19 cm

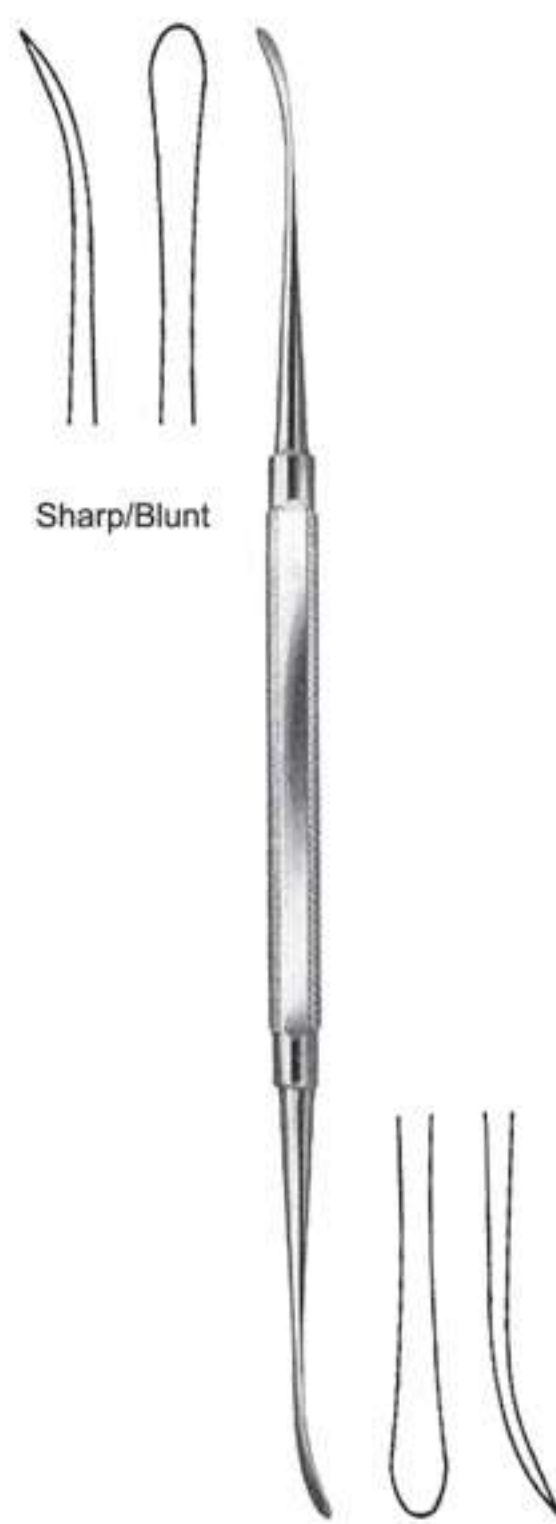

200-006  
Freer  
18,5 cm



200-007  
Freer-Yasargin  
18,5 cm



200-008  
Kendzia  
17 cm



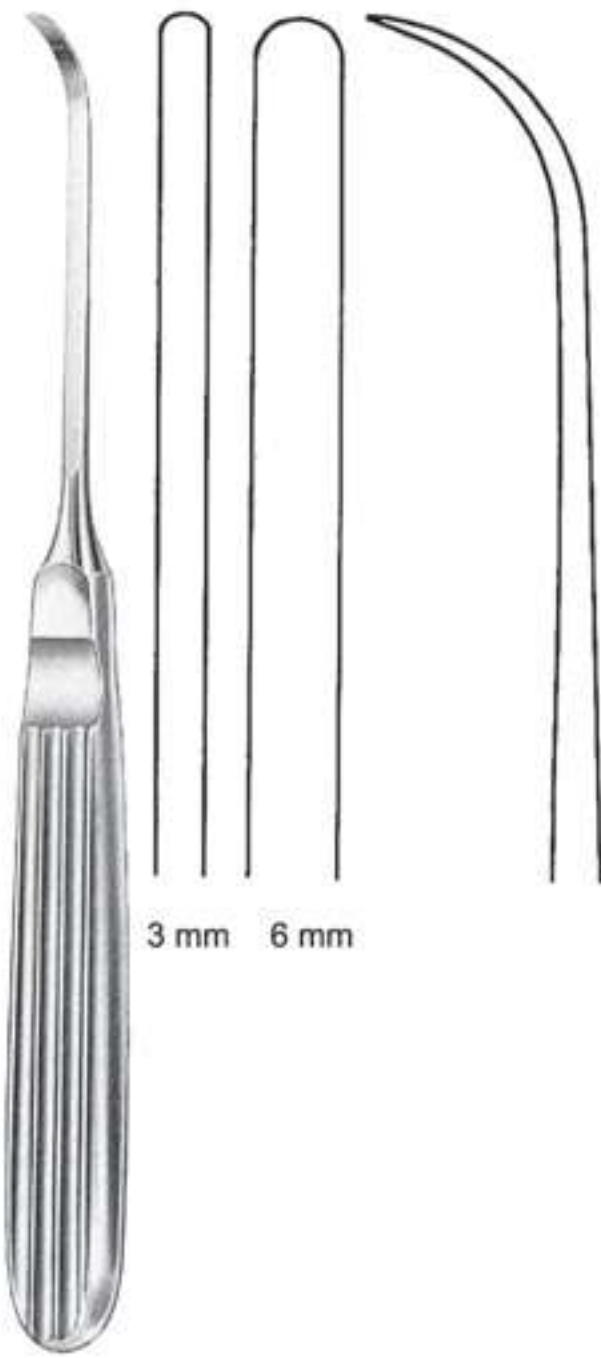

200-009 3 mm  
200-010 6 mm  
17 cm

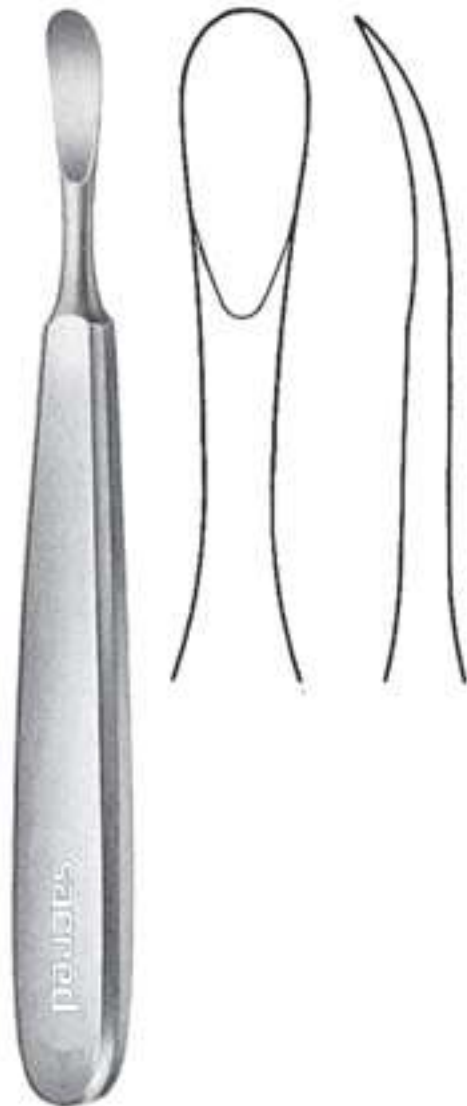

200-011 8 mm  
Trelat  
14 cm



200-012  
Konig  
15,5 cm



200-013  
Williger  
14 cm

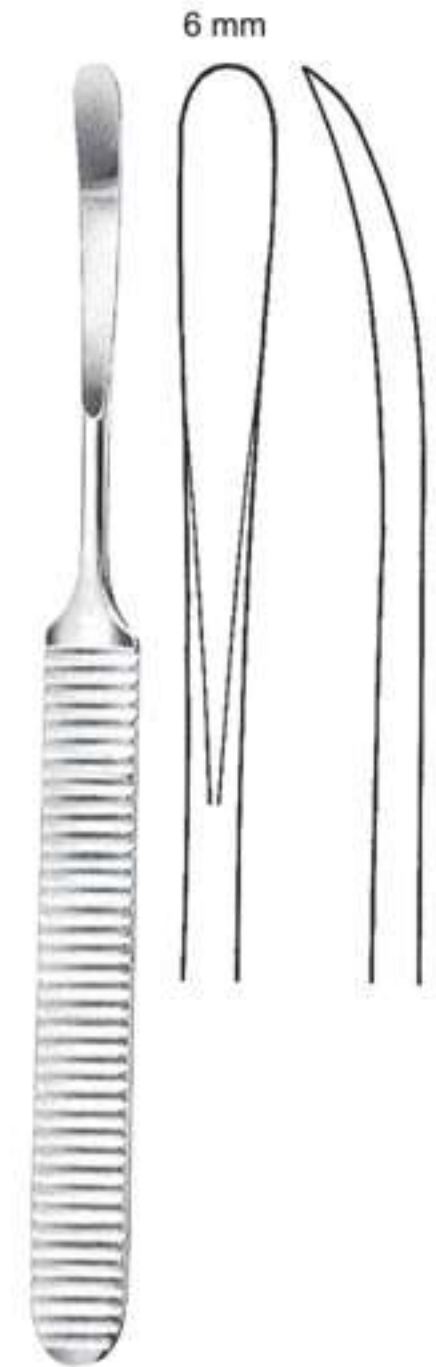

200-014  
Williger  
16 cm



200-015 6 mm  
16,5 cm

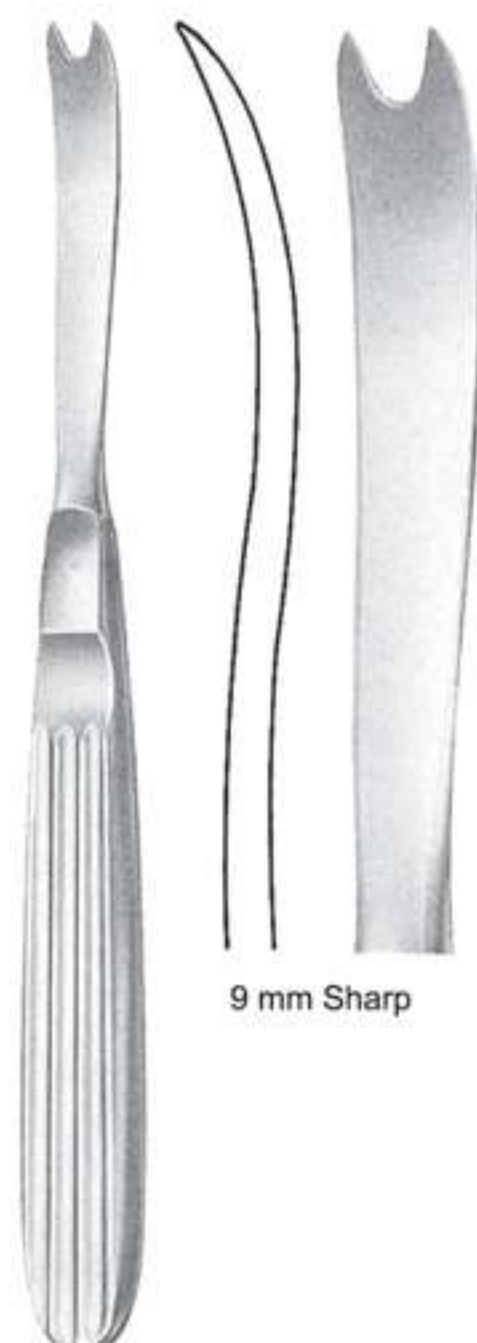

200-017  
Obwegeser  
17 cm

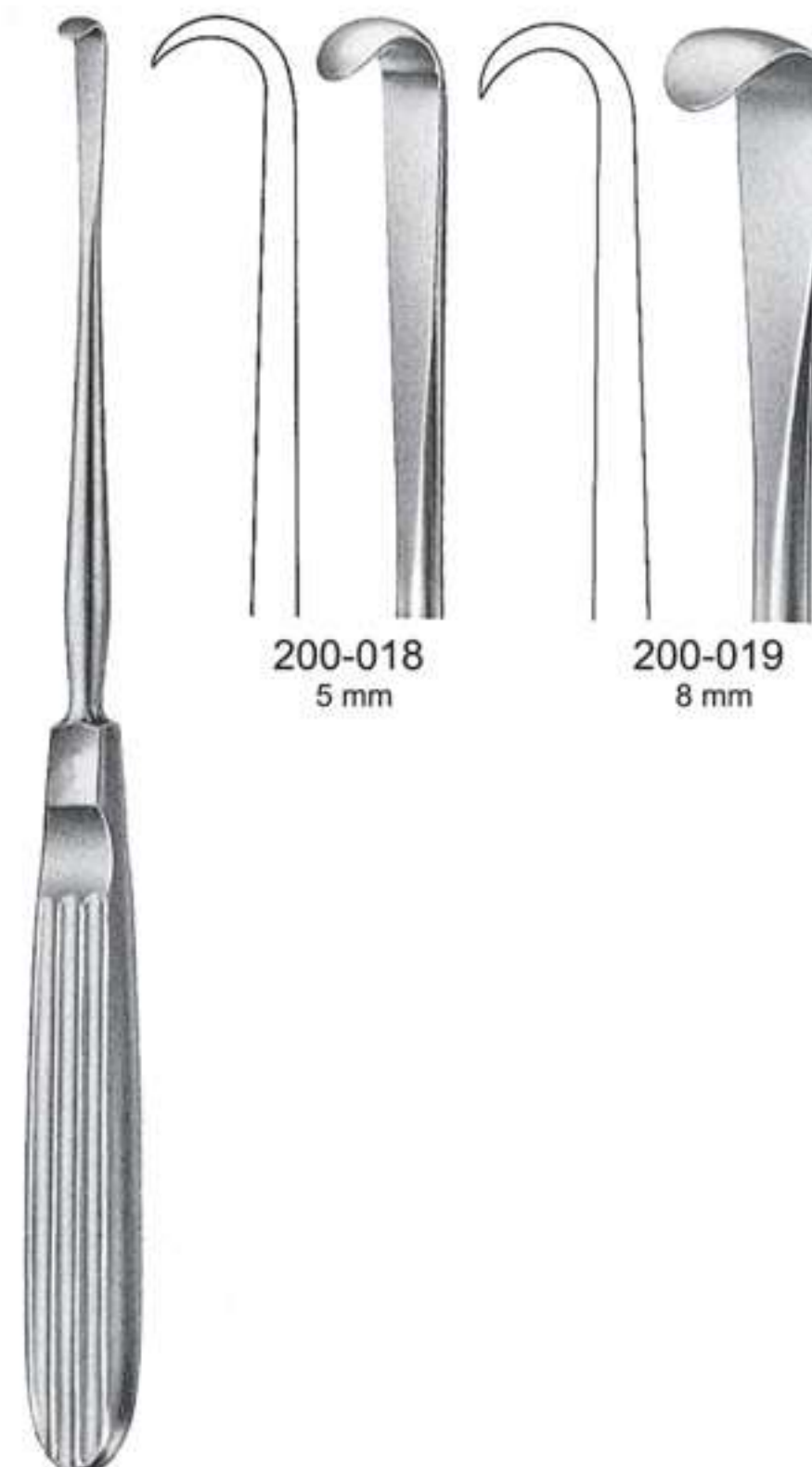

200-018 5 mm  
20 cm



200-020  
Tessier  
22 cm



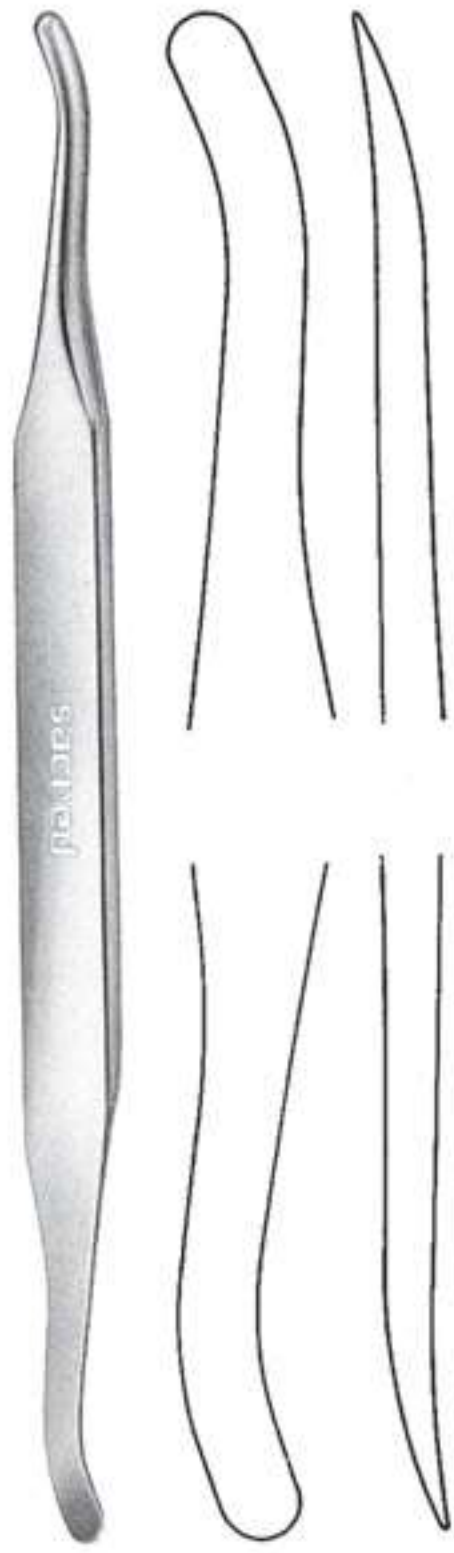

200-021  
Scldin  
19,5 cm

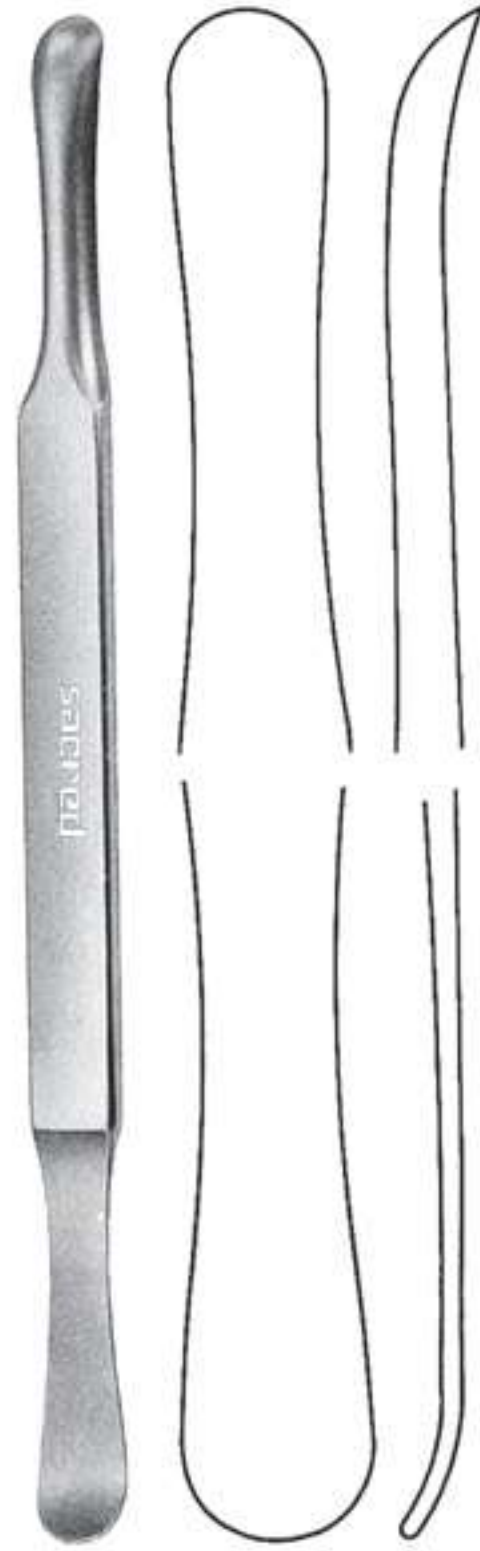

200-022  
Scldin  
19,5 cm



200-023  
Chompret  
15 cm



200-023 200-024



200-025 200-026



200-027  
Freer  
16 cm



200-028  
Freer  
16 cm



200-029  
Partsch,mod  
14,5 cm



200-030  
Mead  
16,5 cm



200-031  
Mead  
18 cm





200-144SYR

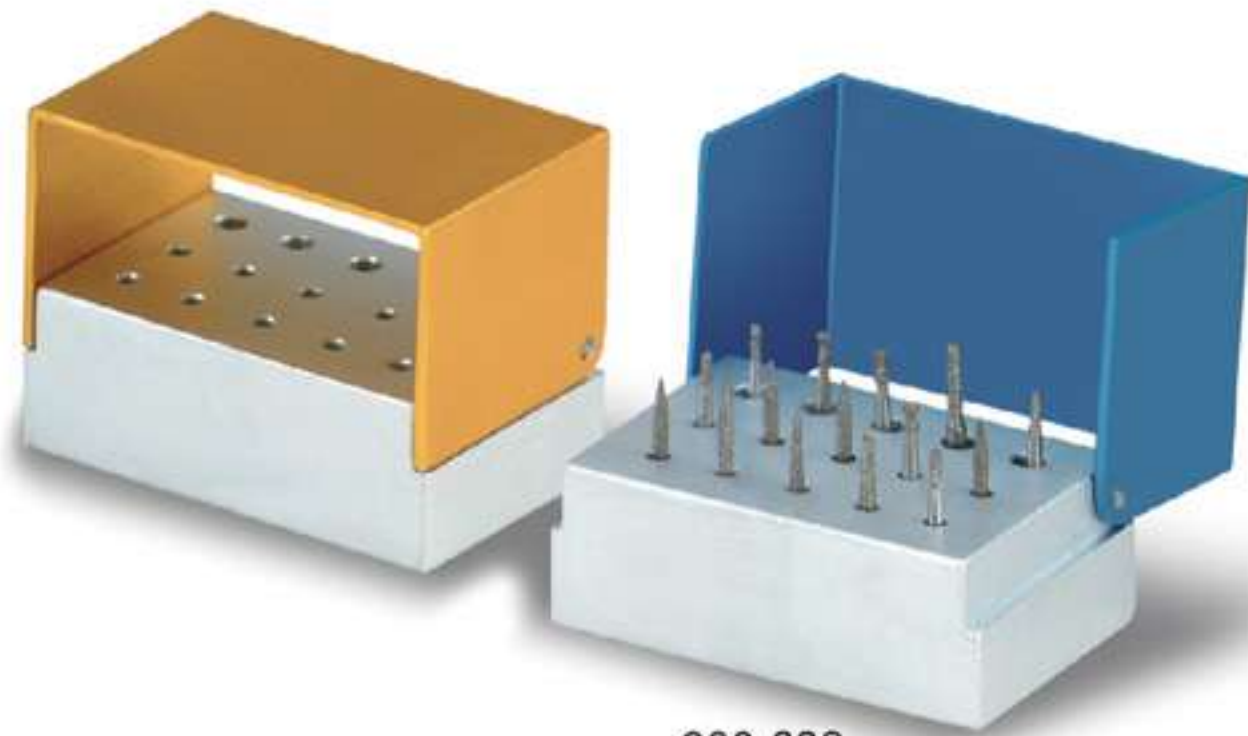

300-008  
for 15 Burs

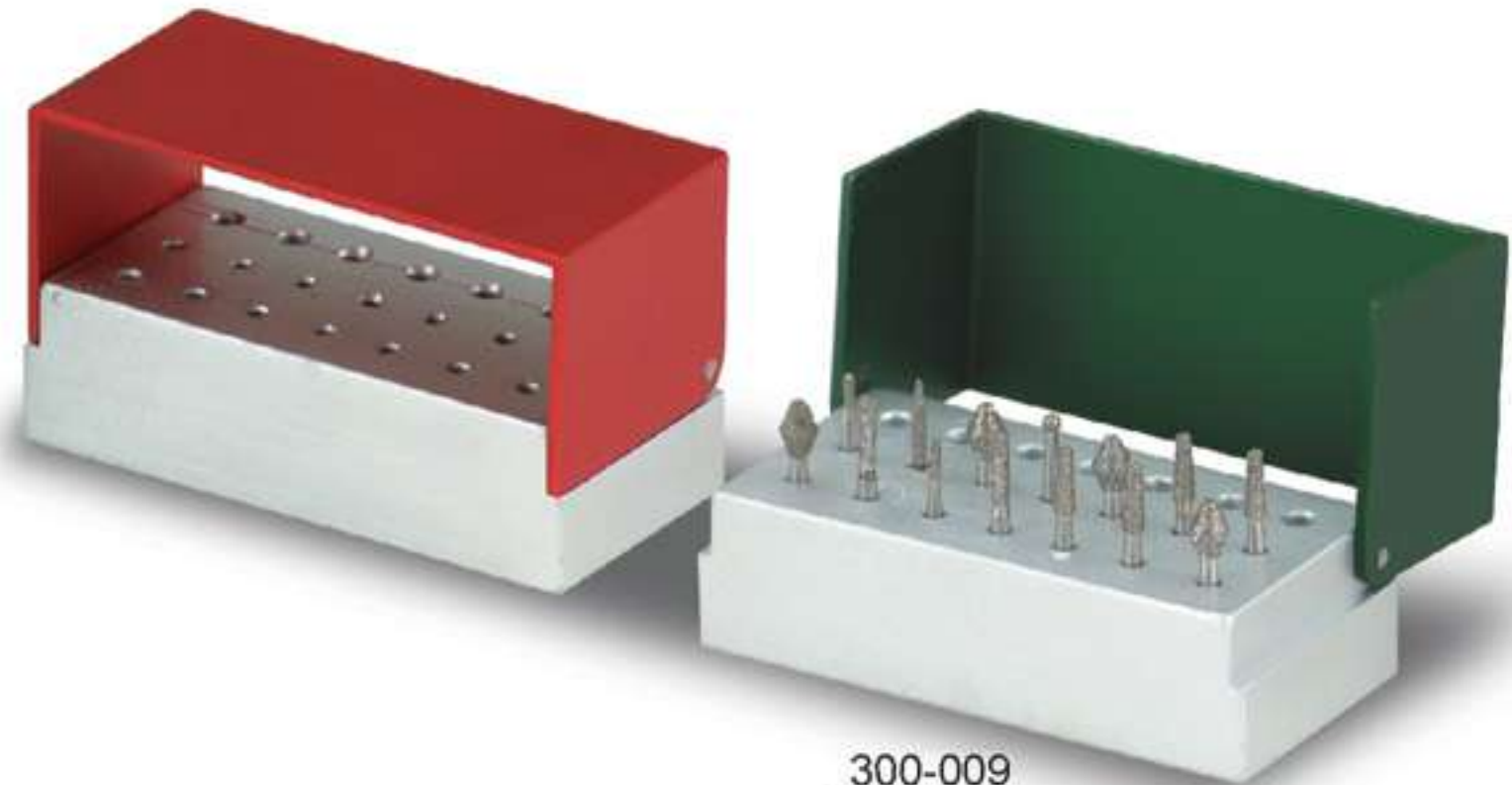

300-009  
for 21 Burs



300-010 for 5 Burs  
300-011 for 7 Burs  
300-012 for 9 Burs



300-014  
Magnetic Burs Holder





200-032  
Partsch  
17 cm



200-033  
Freer  
16 cm



200-034  
Freer  
16 cm



200-035  
Lucas  
16 cm



200-036  
Lucas  
16 cm



200-037  
Lambotte  
12,5 cm



200-038  
14 cm



200-039  
Partsch  
14 cm



200-040  
Partsch  
17 cm

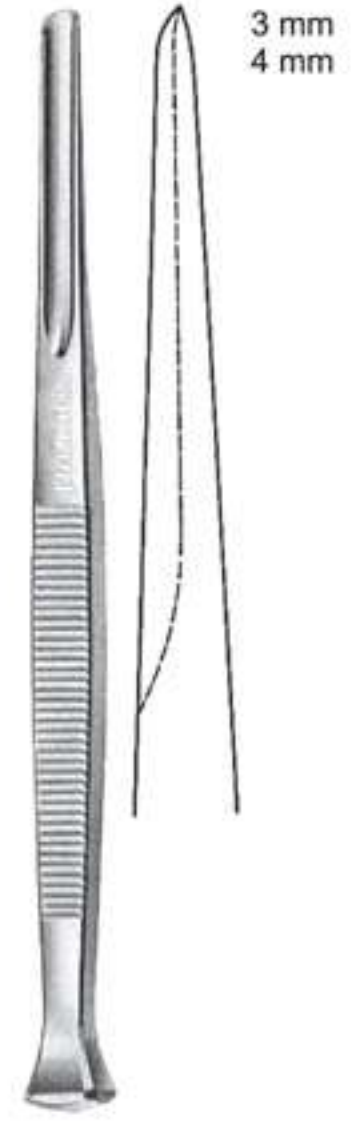

200-041  
Partsch  
14 cm



Calmp forceps



200-042  
Ivory lightweight  
17 cm

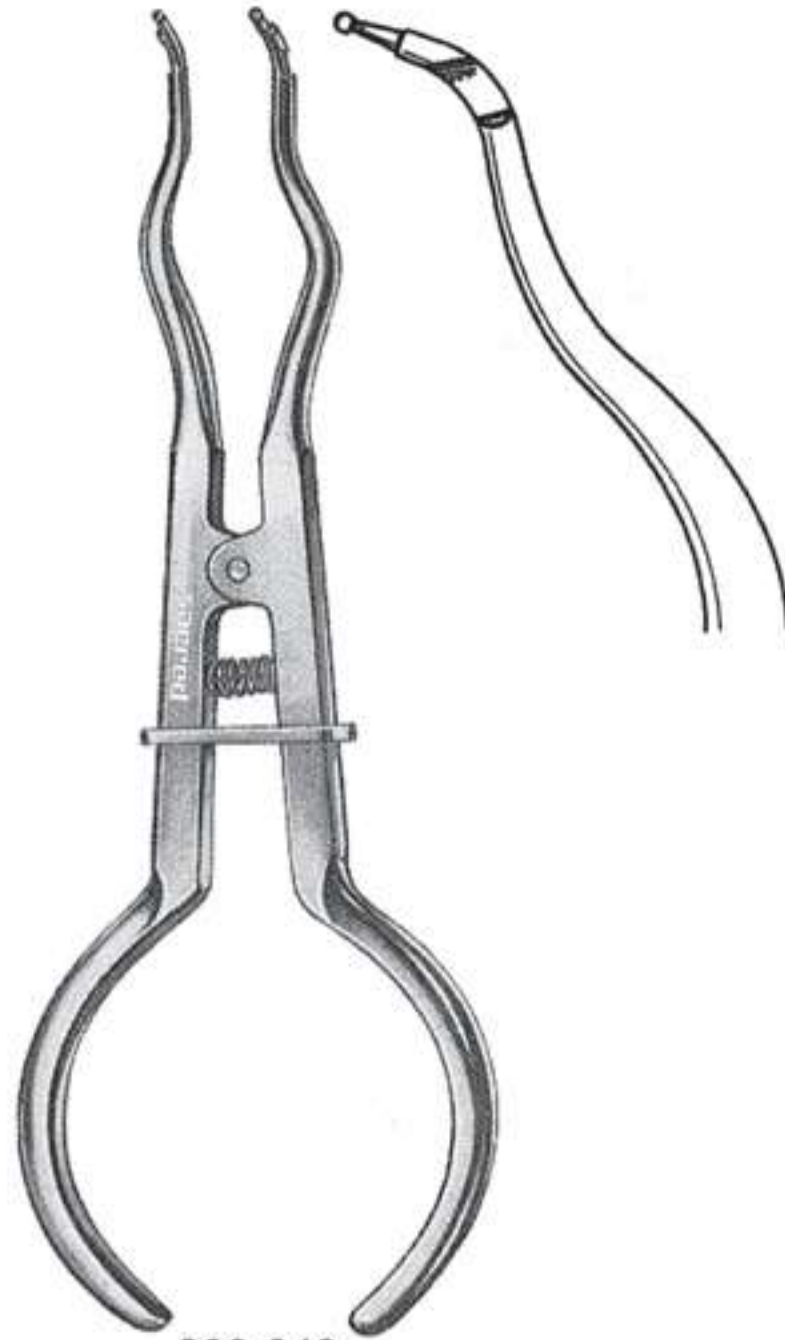

200-043  
Brewer  
17,5 cm

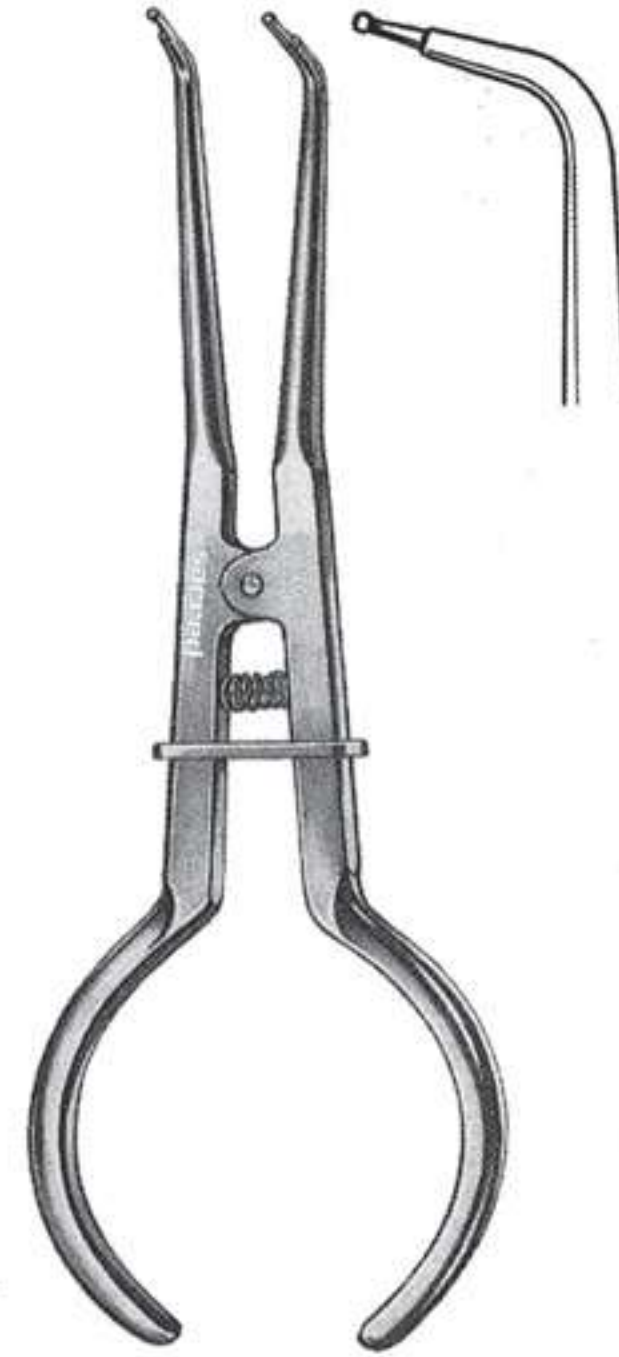

200-044  
Stoke  
17,5 cm

Punch forceps



200-045  
Ainsworth  
17 cm



200-046  
Ivory  
17 cm



200-141  
Ivory  
17 cm



Rubber Dam Frame

200-047



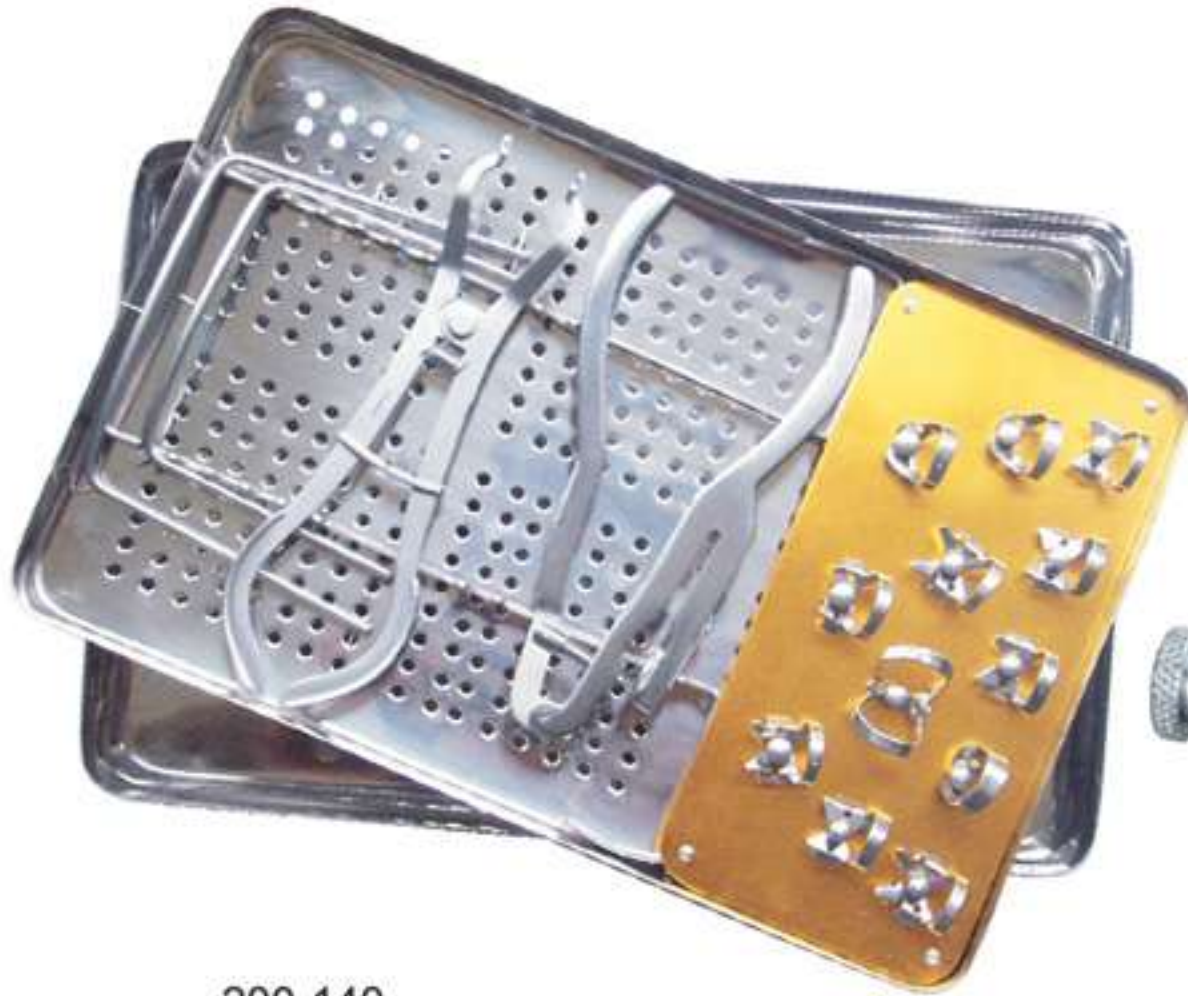

200-140  
Rubber Dam Kit

200-139  
Clamp Kit



300-024



300-017



300-006



300-018



300-019

Articulators are available in different Colors



Molar Clamps Wingless



200-048  
Fig. 30



200-049  
Fig. 31



200-050  
Fig. 51



200-051  
Fig. 138



200-052  
Fig. 139



200-053  
Fig. 15



200-054  
Fig. 18



200-055  
Fig. 24



200-056  
Fig. 25



200-057  
Fig. 26



200-058  
Fig. 28

Bicuspid Clamps Winged



200-059  
Fig. 206



200-060  
Fig. 207



200-061  
Fig. 208



200-062  
Fig. 209



200-063  
Fig. 22



200-064  
Fig. 27



200-065  
Fig. 29

Molar Clamps Wingless



200-066  
Fig. 26



200-067  
Fig. 28



200-068  
Fig. 30



200-069  
Fig. 31



200-070  
Fig. 51

Bicuspid Clamps Winless



200-071  
Fig. 27



200-072  
Fig. 29



200-073  
Fig. 60

Molar Clamps Winged



200-074  
Fig. 200



200-075  
Fig. 201



200-076  
Fig. 202



200-077  
Fig. 203



200-078  
Fig. 204



200-079  
Fig. 205

Labial Clamps Winged



200-080  
Fig. 210



200-081  
Fig. 211



200-082  
Fig. 212



Ø1,5 mm



200-083  
Small

Ø2 mm



200-084  
Medium

Ø2,5 mm



200-085  
Large

Ø3 mm



200-086  
Jumbo



200-087  
Amalgam well

Ø2 mm



200-088  
Medium /Small

Ø2 mm



200-089  
Medium /Large

Ø2 mm



200-090  
Medium /Jumbo



200-091

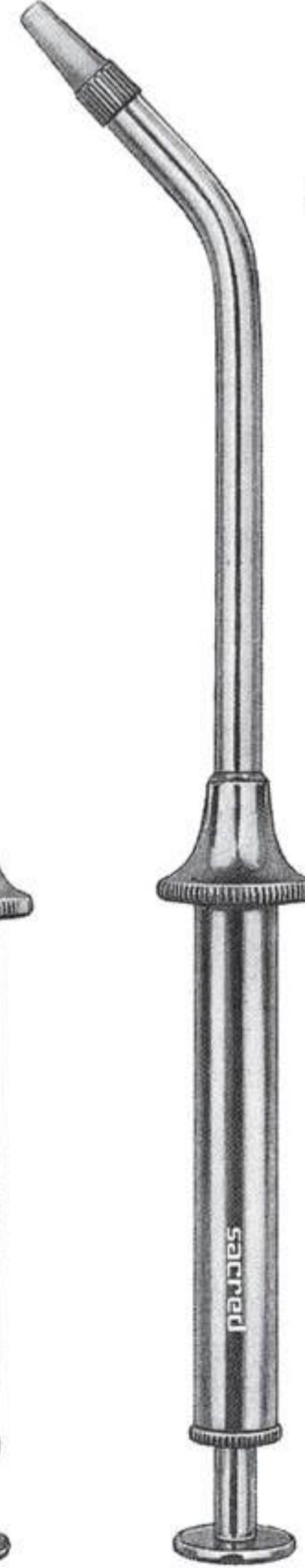

200-092

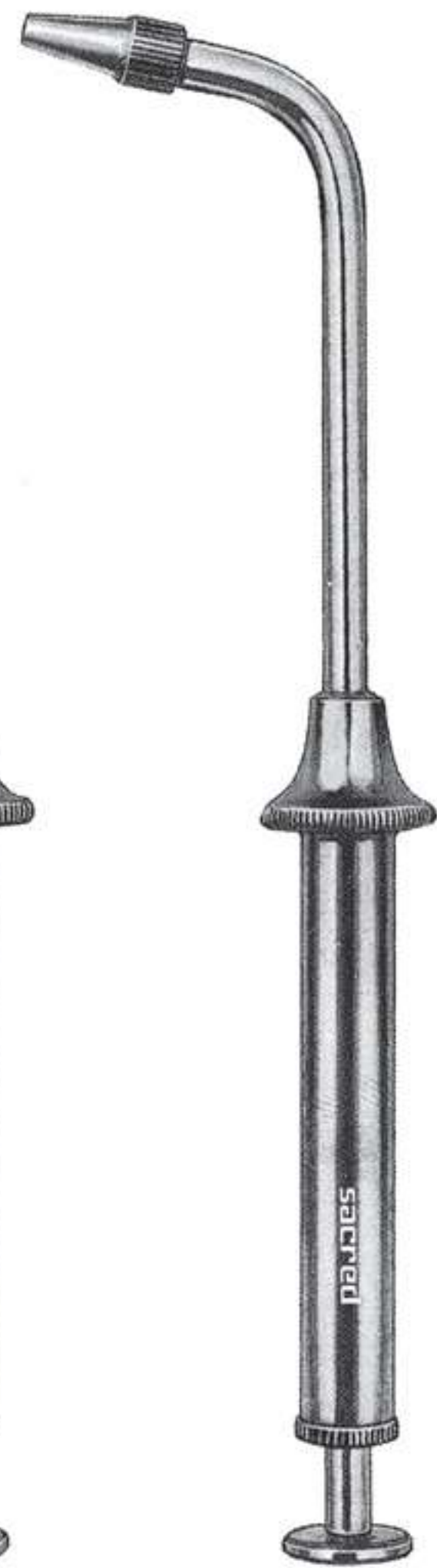

200-093





200-094  
Intraligmentary Syringe  
1,8 ml

200-142  
Intraligmentary Syringe  
1,8 ml



200-095  
Cartridge Syringe  
2,2 ml  
1,8 ml



200-096  
Aspirated Syringe  
1,8 ml

200-097  
Aspirated Syringe  
1,8 ml

200-098  
Cartridge Syringe  
1,8 ml

Available Thread:- Inches & Metric





200-099  
Chip Blower

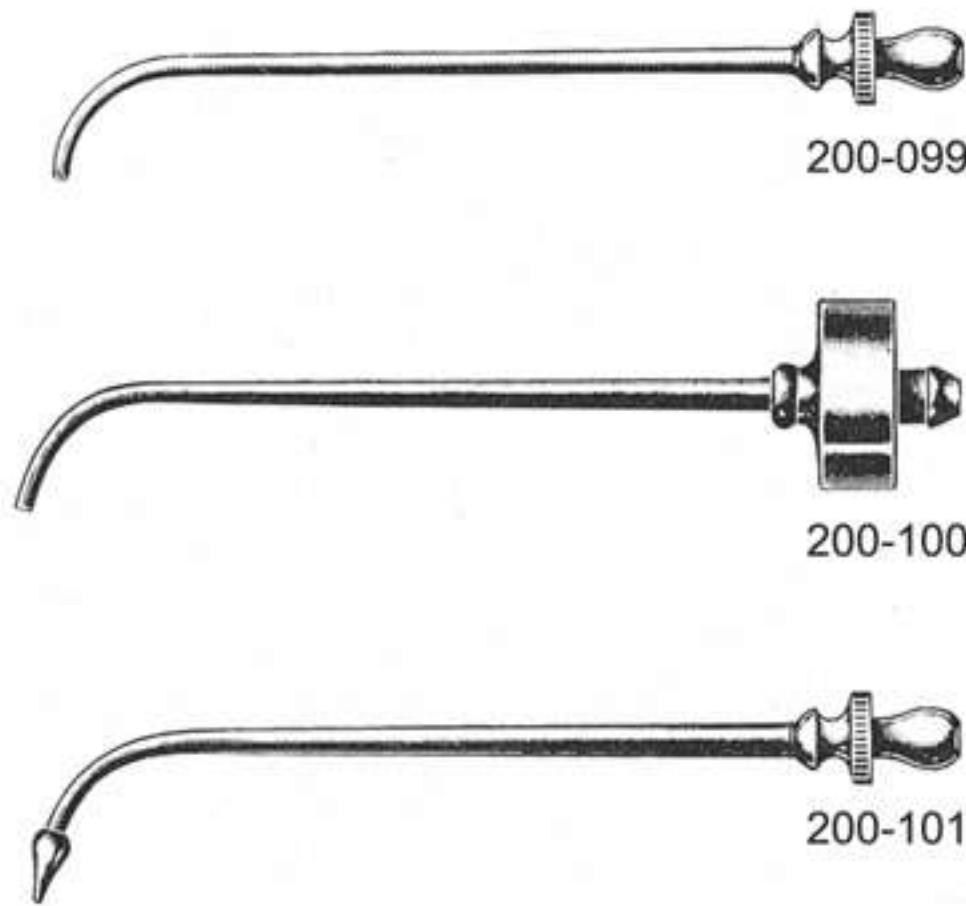

200-099

200-100

200-101



200-104  
Film Holder for  
10 films  
200-105  
6 films  
200-106  
14 films



200-102  
Water Syringe



200-103  
Water Syringe

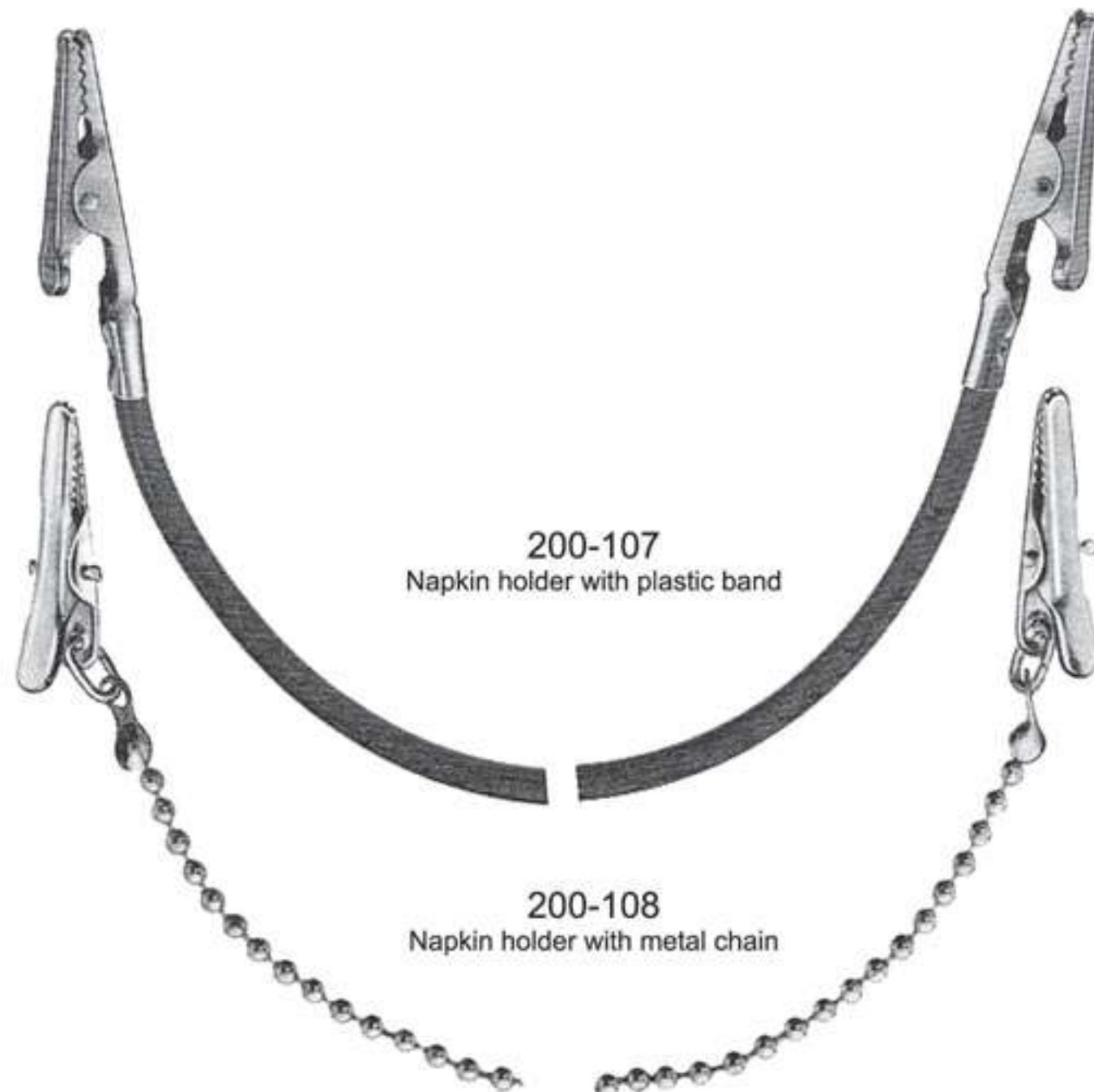

200-107  
Napkin holder with plastic band

200-108  
Napkin holder with metal chain





200-109 - 5mm  
200-110- 6mm  
200-111 - 7mm  
Ivory 8



200-112  
Ivory 8 N



200-113  
Ivory 8



200-114  
Siqveland-Narrow  
200-115  
Siqveland-Wide



200-116  
Fig. 1  
Tofflemire-Universal



200-117  
Fig. 3  
Tofflemire-Senior



200-118  
Fig. 2  
Tofflemire-junior



200-119  
Fig. 2  
Didner 8P



200-120  
Ivory



200-121  
Ivory



200-122  
Ivory  
Separator



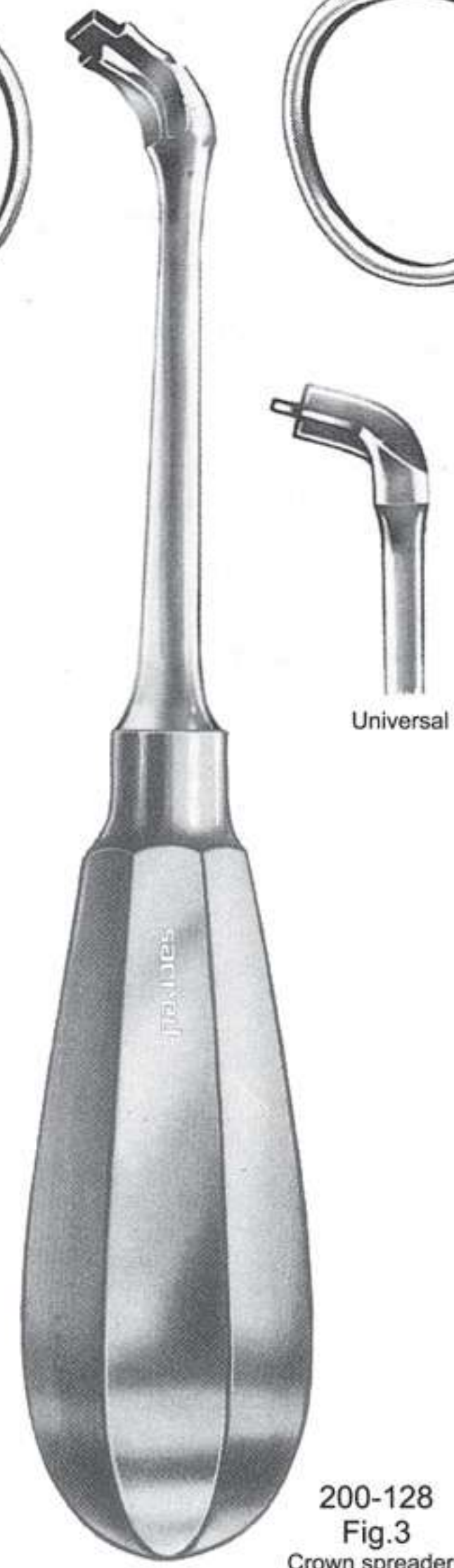





200-130  
Crown removers



200-132  
Crown removers



with 5 Points



200-131  
Crown removers  
Automatic



200-133  
Crown removers







Articulating paper forceps

200-134  
15 cm



200-135  
Miller  
15 cm



200-136  
Crown Spreader



200-143  
Crown Gripper  
Tungsten Carbide Inserts



200-137  
17 cm  
200-138  
20 cm  
Plaster Cutting Plier



Impression Trays  
Set Of 10  
225-001S



**Solid Partial Set of 10  
225-001S**

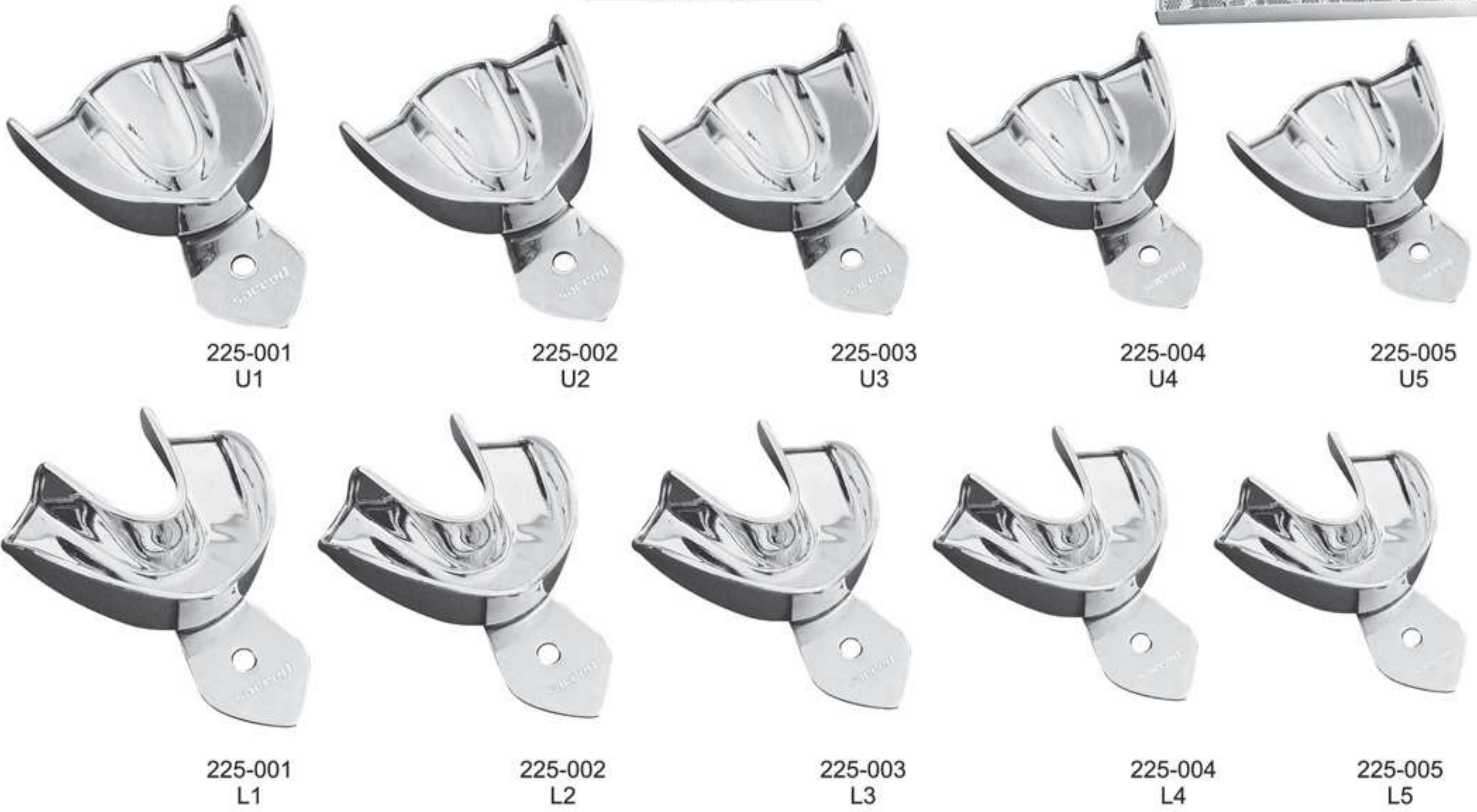

225-001  
U1

225-002  
U2

225-003  
U3

225-004  
U4

225-005  
U5

225-001  
L1

225-002  
L2

225-003  
L3

225-004  
L4

225-005  
L5

All the above impression trays are available in these 5 sizes

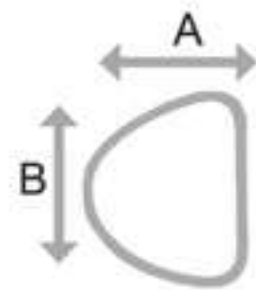

UPPER		U1	U2	U3	U4	U5
	A	62	60	53	54	52
B	83	75	73	69	68	

All Dimension are in mm

LOWER		L1	L2	L3	L4	L5
	A	63	61	57	60	53
B	82	81	78	74	71	

All Dimension are in mm

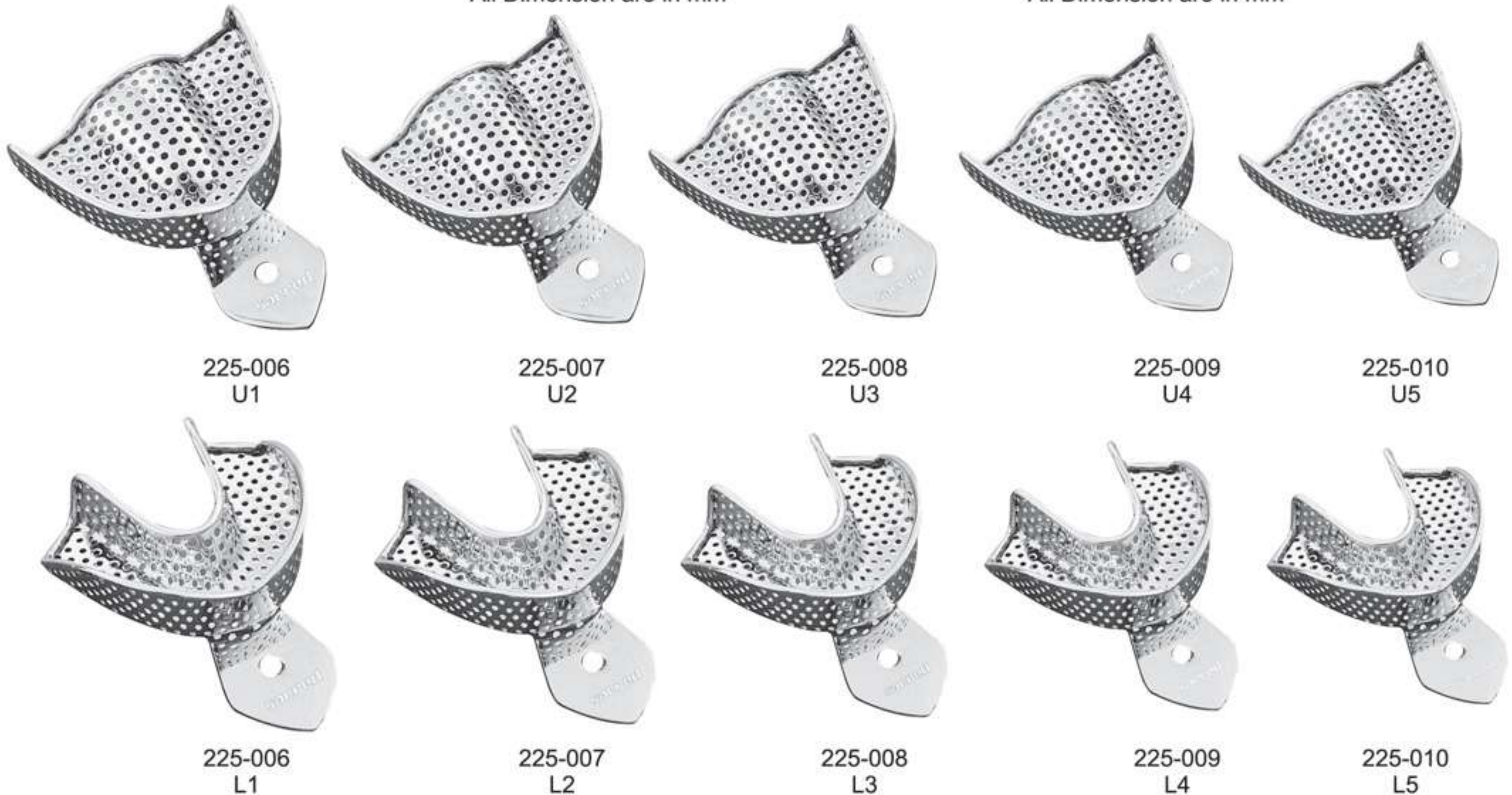
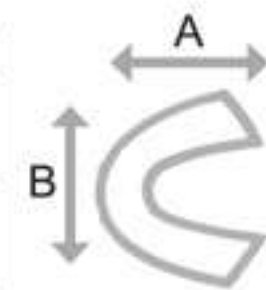

225-006  
U1

225-007  
U2

225-008  
U3

225-009  
U4

225-010  
U5

225-006  
L1

225-007  
L2

225-008  
L3

225-009  
L4

225-010  
L5

**Perforated Partial Set of 10  
225-010S**



**Solid Full Denture Set of 8  
225-011S**



All the above impression trays are available in these 4 sizes

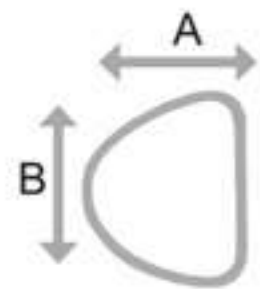

UPPER		XL	L	M	S
	A	70	67	64	60
B	79	76	70	73	

All Dimension are in mm

LOWER		XL	L	M	S
	A	64	64	60	57
B	86	70	73	70	

All Dimension are in mm

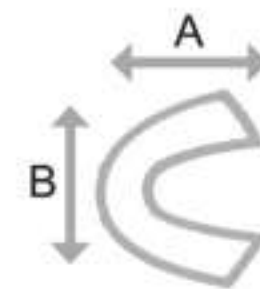

**Perforated Full Denture Set of 8  
225-018S**



**Solid Set of 6  
225-019S**



All the above impression trays are available in these 3 sizes

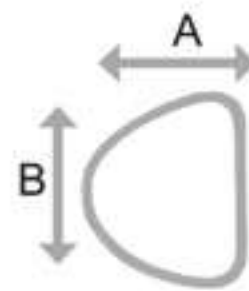

UPPER		U1	U2	U3
	A	67	64	57
B	81	71	70	

All Dimension are in mm

LOWER		L1	L2	L3
	A	60	57	54
B	81	79	76	

All Dimension are in mm

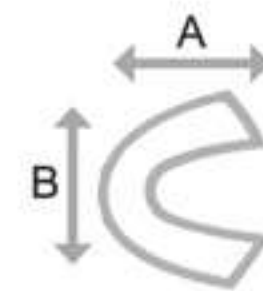

**Perforated Set of 6  
225-024S**



English Pattern



225-025  
Lower

Set of 8  
225-025S

Mesh type



225-025  
Upper



225-026  
Lower

Set of 8  
225-026S

Punched type



225-026  
Upper



225-027  
Lower

Set of 8  
225-027S

Solid type



225-027  
Upper

All the above impression trays are available in these 4 sizes

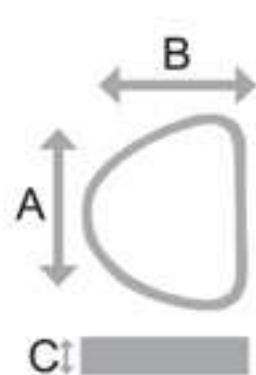

UPPER	Size	A	B	C
	0	67	50	12
	1	72	51	13
	2	78	55	15
	3	80	58	15

All Dimension are in mm

LOWER	Size	A	B	C
	0	70	50	14
	1	77	51	15
	2	79	55	15
	3	80	60	17

All Dimension are in mm

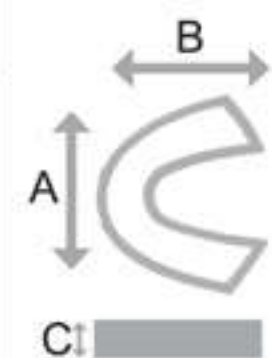



**Solid Full Denture Set of 8  
225-028S**



225-028  
XL



225-029  
L



225-030  
M



225-031  
S



225-028  
XL



225-029  
L



225-030  
M



225-031  
S

All the above impression trays are available in these 4 sizes

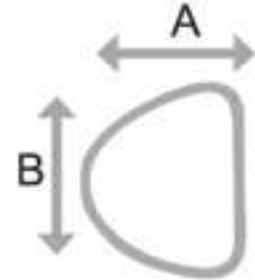

UPPER		XL	L	M	S
	A	70	67	64	60
B	79	76	70	73	

All Dimension are in mm

LOWER		XL	L	M	S
	A	64	64	60	57
B	86	70	73	70	

All Dimension are in mm

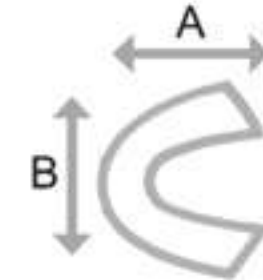

225-032  
XL



225-033  
L



225-034  
M



225-032  
XL



225-033  
L



225-034  
M



225-035  
S

**Perforated Full Denture Set of 8  
225-035S**



English Pattern

Solid Full Denture Set of 8  
225-036S



Upper Sizes 0,1,2,3,  
Depth of the tray 15,9 mm  
Height of palate 12,5 mm

Lower Sizes 0,1,2,3,  
Depth of the tray 12,9 mm



Perforated Full Denture Set of 8  
225-043S



**Impression trays for crown & bridge work**



225-044  
U1P



Solid  
225-044  
L1P



225-045  
U1P



Perforated  
225-045  
L1P



225-046  
For upper right jaw  
For lower left jaw

Perforated



225-047  
For upper left jaw  
For lower right jaw



225-048  
Adjustable  
Perforated



225-048A  
Adjustable  
Solid

Available in 4 Sizes

- 1..... 44 mm
- 2.....55 mm
- 3.....60 mm
- 4.....65 mm

Also available in Solid pattern



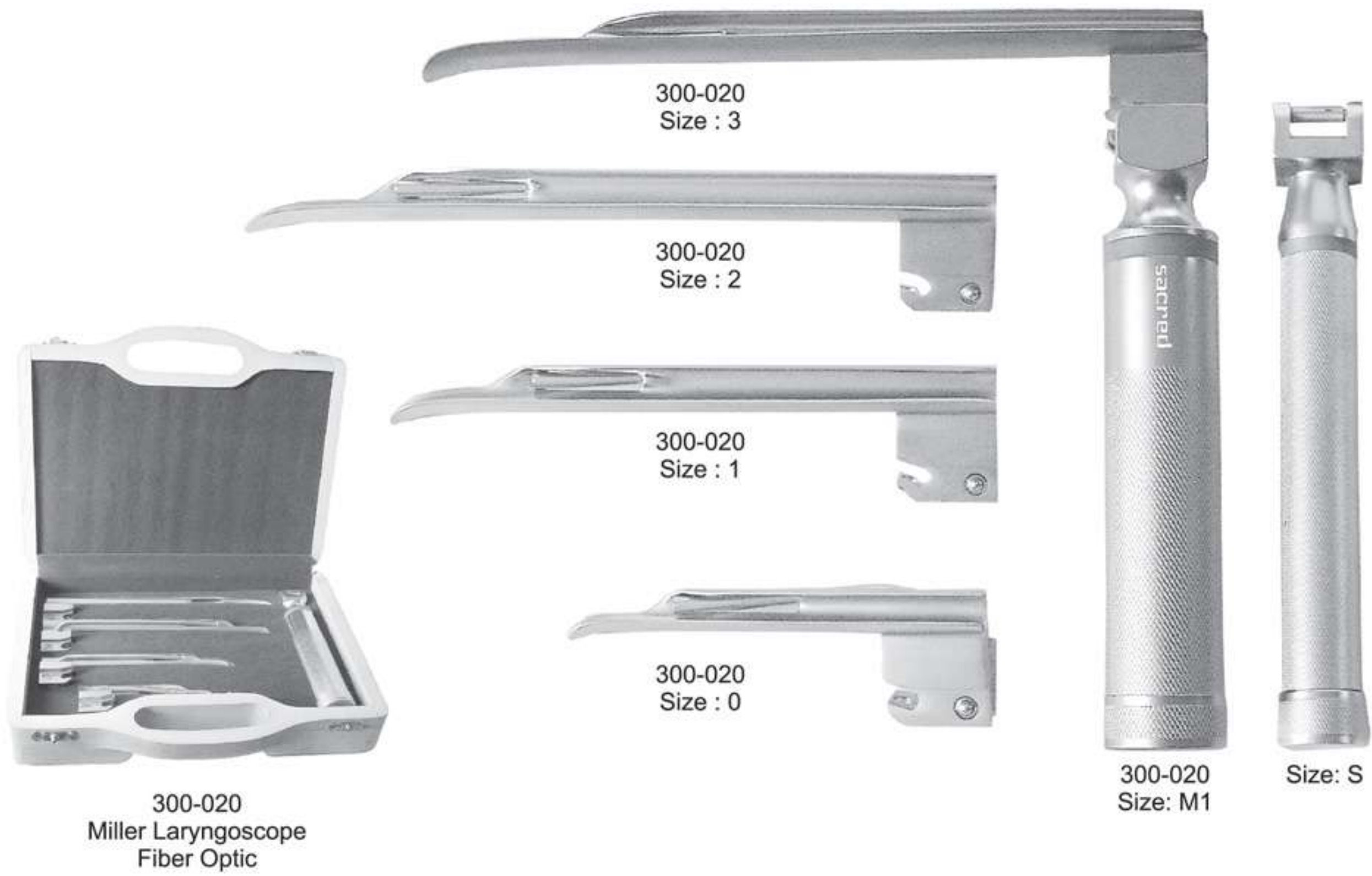

Also available in standard illumination



**225-050S**  
Complete instrument tray with perforated base,  
lid & insert frame for 16 instrument



**225-049**  
Lid; dimensions mm, 288x187x29

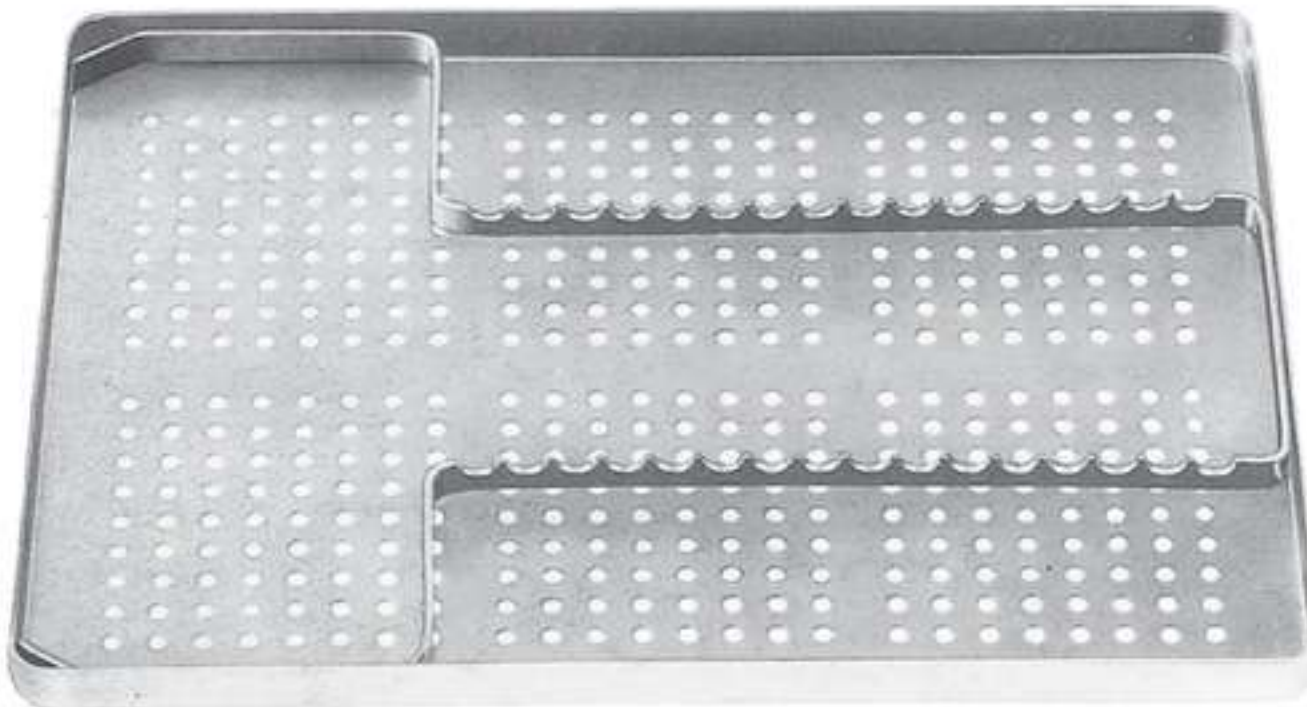

**225-050**  
Perforated base; dimensions 284x183x17 mm

**225-054S**  
Complete instrument tray with perforated base,  
lid & insert frame for 23 instrument



**225-053**  
Lid; dimensions mm, 288x187x29

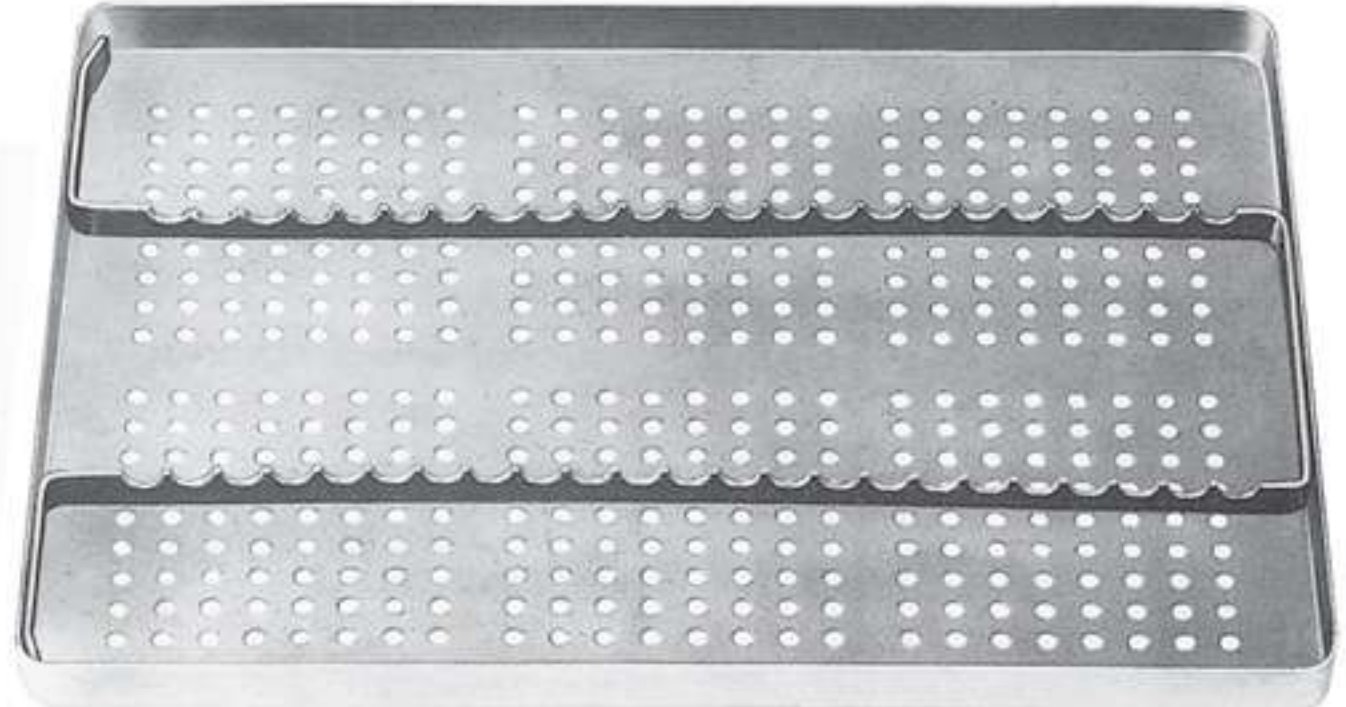

**225-054**  
Perforated base; dimensions 284x183x17 mm

**225-051S**  
Complete instrument tray with solid base,  
lid & insert frame for 16 instrument



**225-051**  
Lid; dimensions 288x187x29 mm

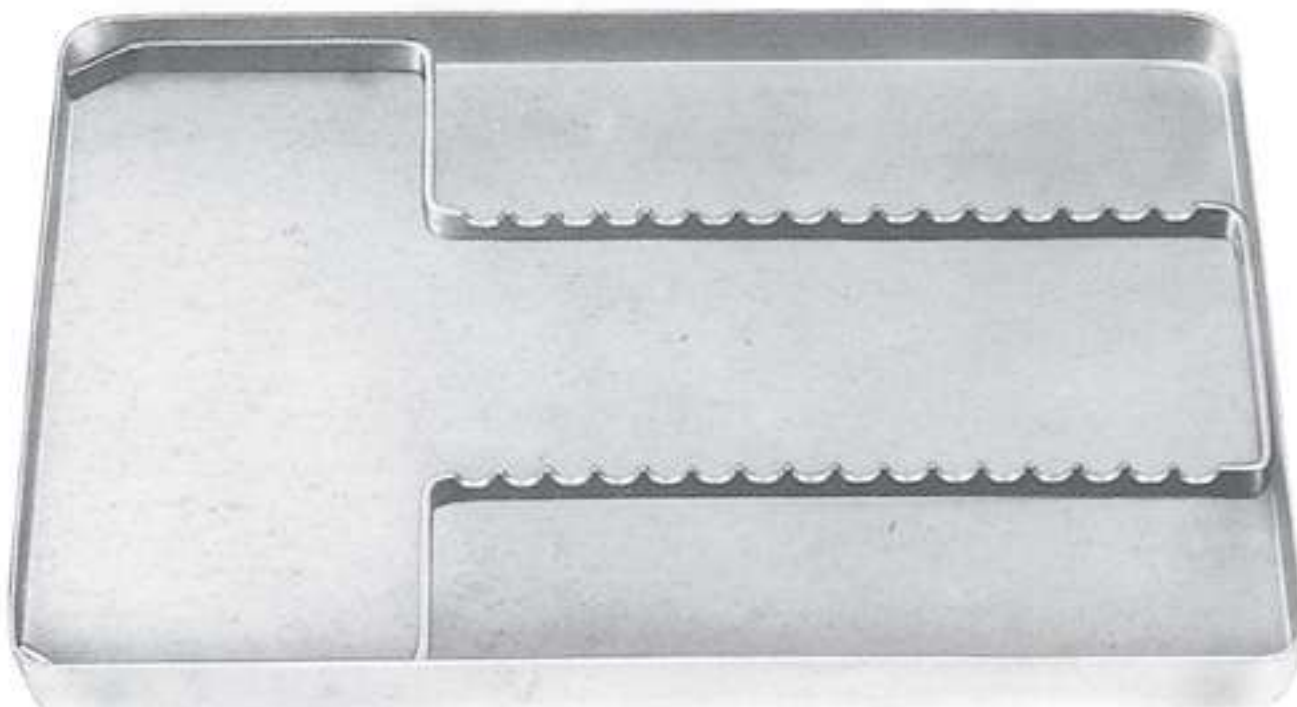

**225-052**  
Solid base; dimensions 284x183x17 mm

**225-055S**  
Complete instrument tray with solid base,  
lid & insert frame for 23 instrument



**225-055**  
Lid; dimensions 288x187x29 mm

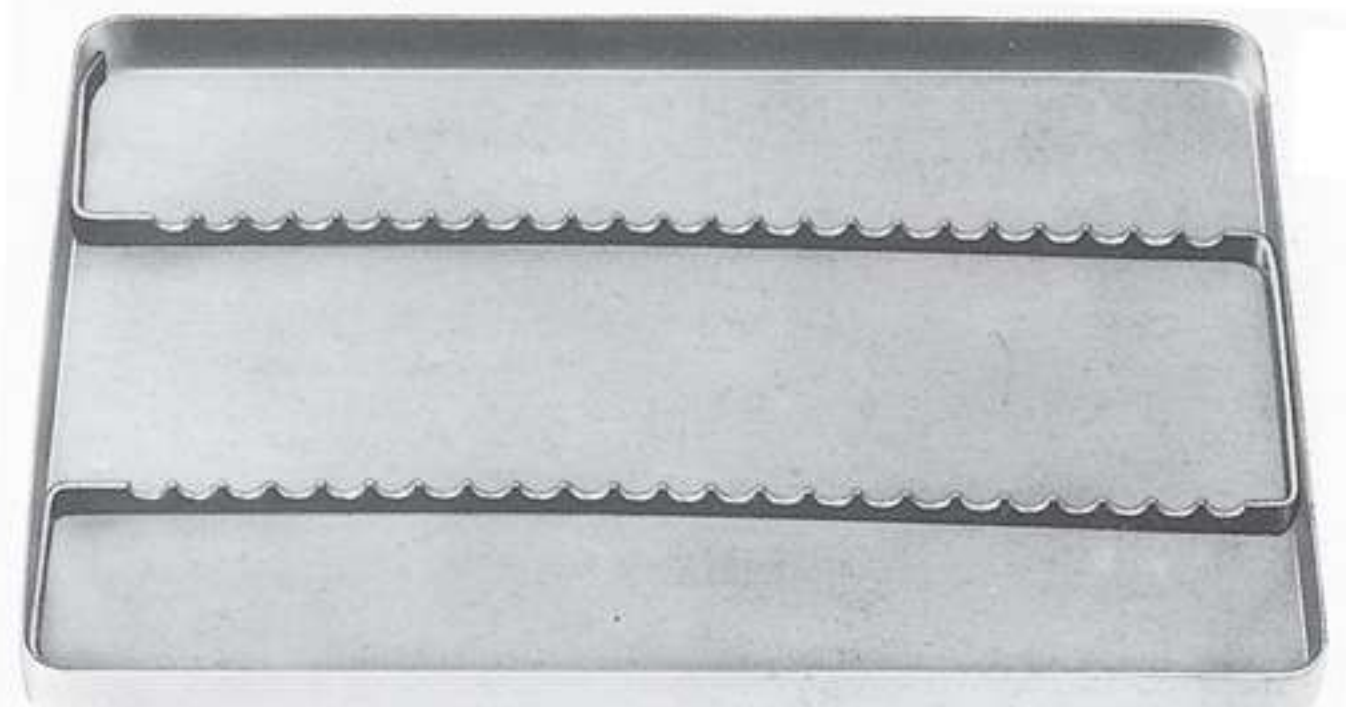

**225-056**  
Solid base; dimensions 284x183x17 mm



Scalers Tray



225-057



225-058  
15 cm x 25 cm  
with lid



225-059  
15 cm x 20 cm  
with lid



225-060  
15 cm x 20 cm  
20 cm x 25 cm  
25 cm x 30 cm  
without lid



225-061



225-062  
Endodontic box



225-063  
20 cm x 30 cm  
with lid





225-064

6 cm x 5 cm  
12 cm x 5 cm  
14 cm x 6.5 cm  
16 cm x 7 cm  
18 cm x 9 cm

Kidney trays



225-065  
30 cm - 25 cm - 20 cm - 15 cm

Deep



225-066  
15 cm x 23 cm - 20 cm x 30 cm

Available in a lot of different sizes according to your requirements

Shallow



225-067  
25 cm x 25 cm



225-068  
Cotton holder

Round bowls



225-069

8 cm x 3.5 cm  
12.5 cm x 6 cm



225-070  
Spirit lamp



225-071  
Spirit lamp



225-072  
Forcep Jar

2.5 cm x 8 cm  
3 cm x 10 cm  
10 cm x 20 cm  
7.5 cm x 17.5 cm





250-001  
Waldsachs  
15 cm



250-002  
Universal  
16 cm



250-003  
Nance  
13,5 cm



250-004  
Aderer  
14,5 cm



250-005  
Modell marburg  
Serrated Jaws  
14 cm



250-006  
Modell marburg  
Smooth jaws  
14 cm

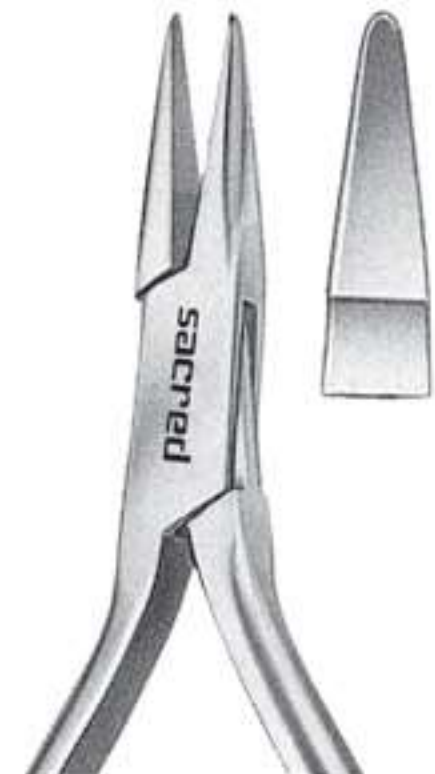

250-007  
Modell marburg  
Carbid Inserts jaws  
14 cm

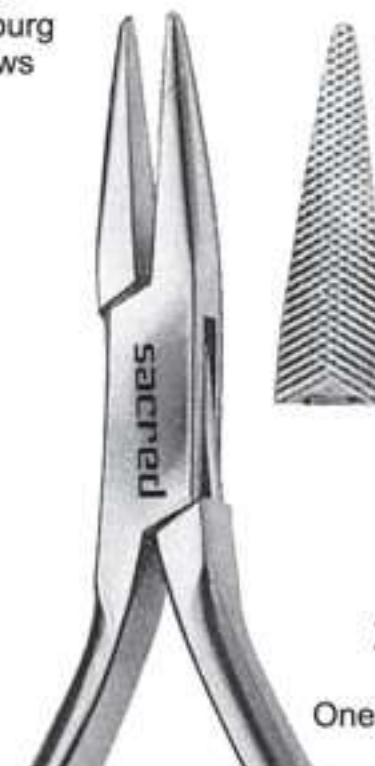

250-008  
Goslee  
One Serrated Jaws  
14 cm





250-009  
14 cm



250-009  
14 cm



250-010  
14 cm



250-011  
14,5 cm



250-012  
14,5 cm



250-013  
14 cm



250-014  
14 cm



250-015  
14 cm



250-016  
Serrated Jaws  
12 cm



250-017  
How  
14,5 cm



250-018  
How-angled  
14,5 cm



250-019  
Arrow clasp forming  
12 cm

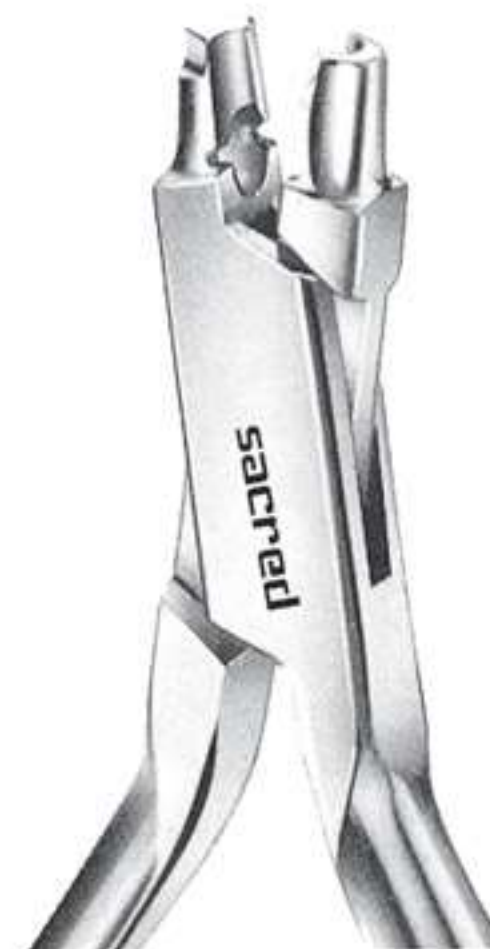

250-020  
Arrow clasp forming  
12 cm



250-021  
Arrow clasp bending  
12 cm





Round nose pliers

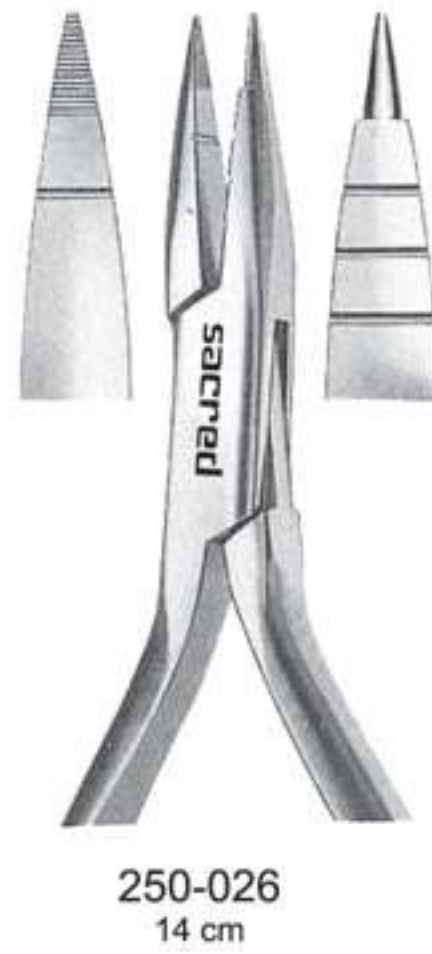

For wire up to

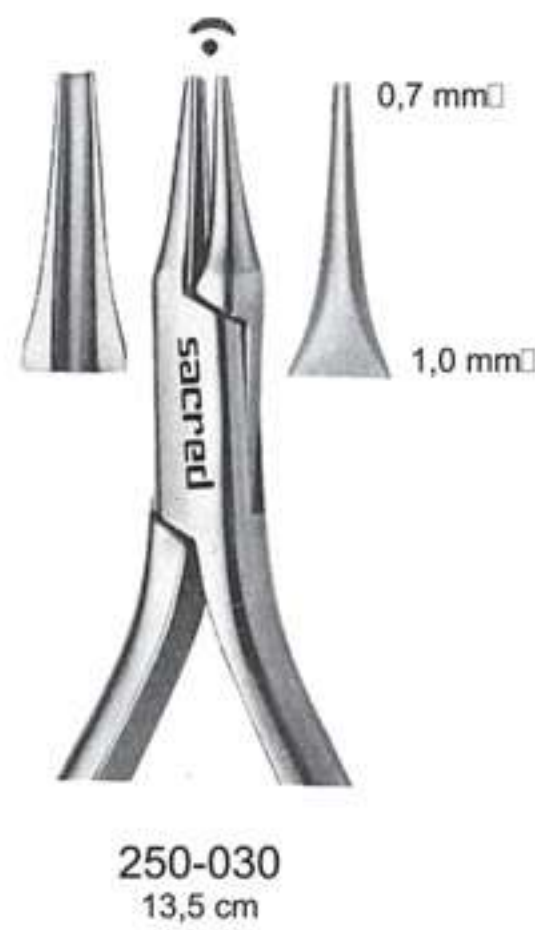





250-033  
Aderer  
12 cm



250-034  
Aderer- Heavy  
12 cm



250-035  
Tweed  
14,5 cm



250-036  
O'Brien  
13,5 cm



250-037  
Wire bending pliers  
12,5 cm



250-038  
Adams  
12,5 cm



250-040  
Young  
14 cm



250-041  
Clasp forming  
14 cm



250-039  
Frevert  
12,5 cm





Ligature instruments

Bracket holding tweezer

250-045  
Elastic instruments

250-046  
Mershon Band Pusher  
14 cm

250-047  
Band Setter with  
tin insert  
15 cm

250-048  
13,5 cm

250-049  
14 cm

250-042  
Band seating &  
removing instruments

250-043

250-044

250-050  
Separating pliers for separators  
15,5 cm







ISO 9001  
ISO 13485  
FDA APPROVED



**sacred**<sup>®</sup>  
*Symbol of quality*

P. O. Box. 233 I, Harrar Rorus Road,  
Sialkot - Pakistan  
Tel: +92-52-3257007 / 3557007  
Fax: +92-52-3563451 / 3552545  
E-mail: [info@sacred.com.pk](mailto:info@sacred.com.pk)  
Web: [www.sacred.com.pk](http://www.sacred.com.pk)